



Parts Manual

Mfg. No: 020673-00
Sprint 2000E, Electric Pressure Washer
with Steam

| Model Components | Page |
|---------------------------------|------|
| Main Unit (80018159)..... | 4 |
| Torque Specification Chart..... | 6 |

Not For
Reproduction

Main Unit (80018159)

Note: Unless noted otherwise, use the standard torque specifications

Mfg. No: 020673-00

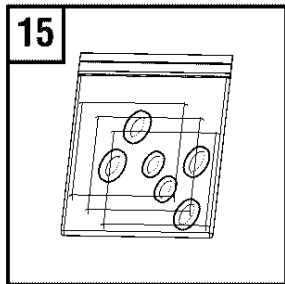
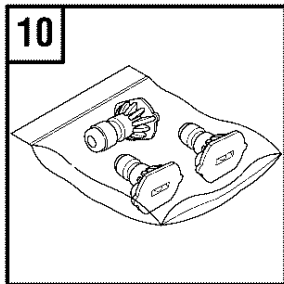
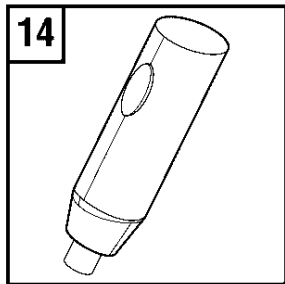
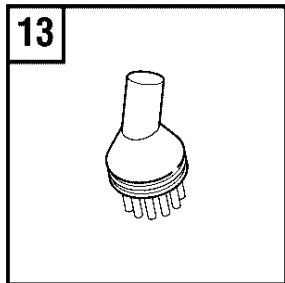
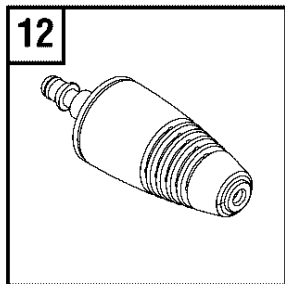
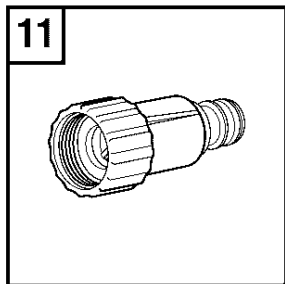
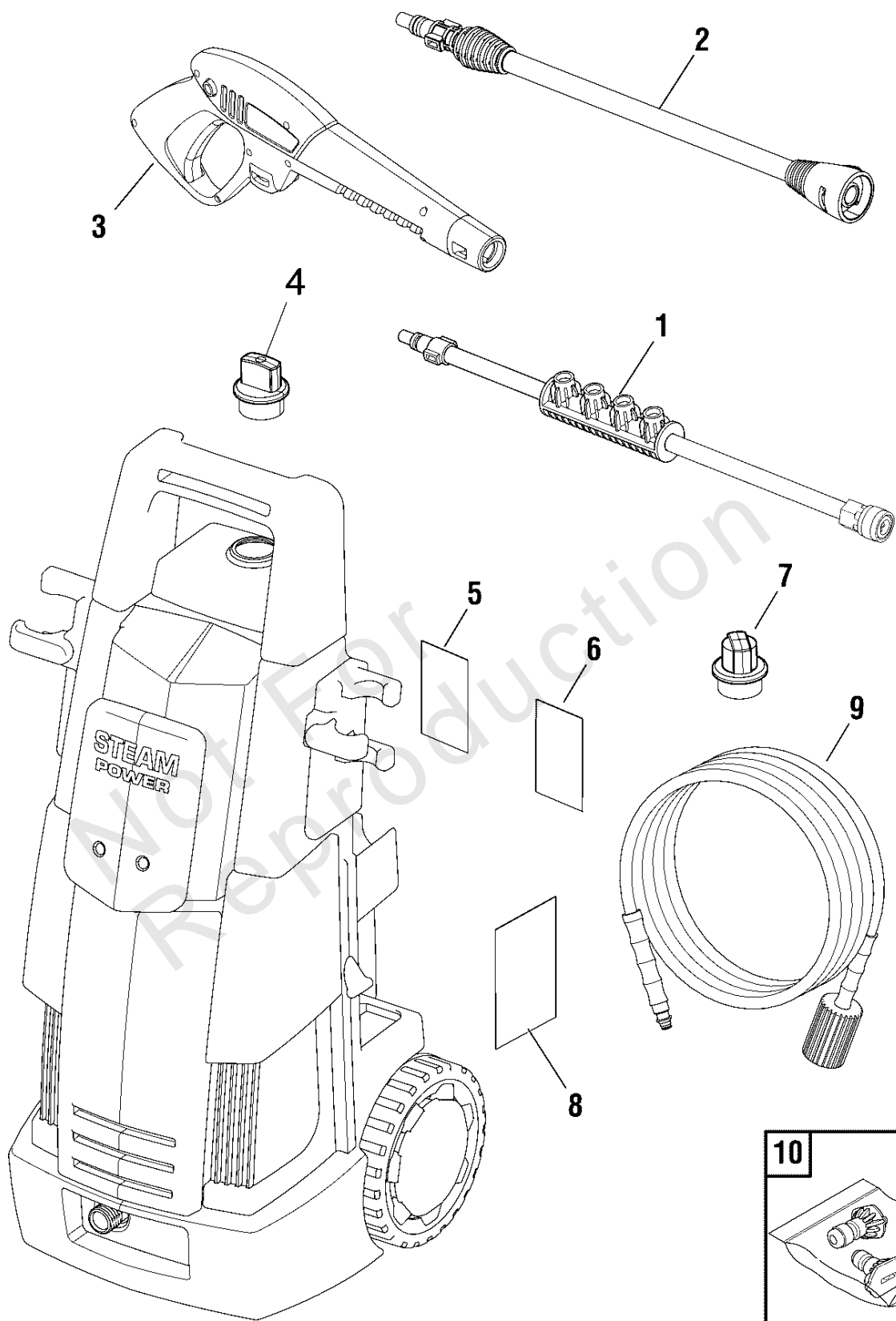

Main Unit (80018159)

| REF NO | PART NO | QTY | DESCRIPTION |
|--------|----------|-----|-------------------------------------|
| 1 | 709967 | | WAND |
| 2 | 317422GS | | WAND |
| 3 | 709709 | | GUN |
| 4 | 709972 | | CAP-STEAM |
| 5 | 709704 | | DECAL-WARNING |
| 6 | 707871 | | DECAL-WARNING |
| 7 | 704378 | | CAP-DETERGENT |
| 8 | 709969 | | DECAL-WARNING |
| 9 | 707852 | | HOSE |
| 10 | 709966 | | KIT-NOZZLES QC |
| -- | 709971 | | NOZZLE-QC YELLOW |
| -- | 709973 | | NOZZLE-QC RED |
| -- | 709968 | | NOZZLE-QC BLACK |
| 11 | 709705 | | FILTER-QC |
| 12 | 317424GS | | NOZZLE-TURBO |
| 13 | 709970 | | BRUSH-STEAM |
| 14 | 709974 | | SLEEVE-STEAM |
| 15 | 315960GS | | KIT-O-RINGS |
| -- | 707740 | | CLEANING WIRE -(Not Illustrated) |
| -- | B2384GS | | FILTER-INLET -(Not Illustrated) |

Hardware Identification & Torque Specifications

| Torque Specification Chart | | | | | | | | |
|--|-----------|------|-----------|------|------------|------|------------|------|
| FOR STANDARD METRIC MACHINE HARDWARE (Tolerance ± 20%) | | | | | | | | |
| Property Class | 5.6 | | 8.8 | | 10.9 | | 12.9 | |
| | Class 5.6 | | Class 8.8 | | Class 10.9 | | Class 12.9 | |
| Size Of Hardware | in/lbs | | in/lbs | | in/lbs | | in/lbs | |
| | ft/lbs | Nm. | ft/lbs | Nm. | ft/lbs | Nm. | ft/lbs | Nm. |
| M3 | 5.88 | .56 | 13.44 | 1.28 | 19.2 | 1.80 | 22.92 | 2.15 |
| M4 | 13.44 | 1.28 | 30.72 | 2.90 | 43.44 | 4.10 | 52.56 | 4.95 |
| M5 | 26.4 | 2.50 | 60.96 | 5.75 | 5.97 | 8.10 | 7.15 | 9.7 |
| M6 | 44.64 | 4.3 | 7.3 | 9.9 | 10.3 | 14 | 12.1 | 16.5 |
| M7 | 5.2 | 7.1 | 12.1 | 16.5 | 16.9 | 23 | 19.9 | 27 |
| M8 | 7.7 | 10.5 | 17.7 | 24 | 25 | 34 | 29 | 40 |
| M10 | 15 | 21 | 35 | 48 | 50 | 67 | 59 | 81 |
| M12 | 26 | 36 | 61 | 83 | 86.2 | 117 | 103 | 140 |
| M14 | 42 | 58 | 101 | 132 | 136 | 185 | 162 | 220 |
| M16 | 64 | 88 | 147 | 200 | 210 | 285 | 250 | 340 |
| M18 | 89 | 121 | 202 | 275 | 287 | 390 | 346 | 470 |
| M20 | 126 | 171 | 290 | 390 | 405 | 550 | 486 | 660 |
| M22 | 169 | 230 | 390 | 530 | 559 | 745 | 656 | 890 |
| M24 | 217 | 295 | 497 | 375 | 708 | 960 | 840 | 1140 |
| M27 | 320 | 435 | 733 | 995 | 1032 | 1400 | 1239 | 1680 |
| M30 | 435 | 590 | 995 | 1350 | 1401 | 1900 | 1681 | 2280 |
| M33 | 590 | 800 | 1349 | 1830 | 1902 | 2580 | 2278 | 3090 |
| M36 | 759 | 1030 | 1740 | 2360 | 2441 | 3310 | 2935 | 3980 |
| M39 | 988 | 1340 | 2249 | 3050 | 3163 | 4290 | 3798 | 5150 |

| Torque Specification Chart | | | | | | |
|---|-------------|-------|-------------|-------|-------------|---------|
| FOR STANDARD MACHINE HARDWARE (Tolerance ± 20%) | | | | | | |
| Hardware Grade | No Marks | | SAE Grade 5 | | SAE Grade 8 | |
| | SAE Grade 2 | | SAE Grade 5 | | SAE Grade 8 | |
| Size Of Hardware | in/lbs | | in/lbs | | in/lbs | |
| | ft/lbs | Nm. | ft/lbs | Nm. | ft/lbs | Nm. |
| 8-32 | 19 | 2.1 | 30 | 3.4 | 41 | 4.6 |
| 8-36 | 20 | 2.3 | 31 | 3.5 | 43 | 4.9 |
| 10-24 | 27 | 3.1 | 43 | 4.9 | 60 | 6.8 |
| 10-32 | 31 | 3.5 | 49 | 5.5 | 68 | 7.7 |
| 1/4-20 | 66 | 7.6 | 8 | 10.9 | 12 | 16.3 |
| 1/4-28 | 76 | 8.6 | 10 | 13.6 | 14 | 19.0 |
| 5/16-18 | 11 | 15.0 | 17 | 23.1 | 25 | 34.0 |
| 5/16-24 | 12 | 16.3 | 19 | 25.8 | 29 | 34.0 |
| 3/8-16 | 20 | 27.2 | 30 | 40.8 | 45 | 61.2 |
| 3/8-24 | 23 | 31.3 | 35 | 47.6 | 50 | 68.0 |
| 7/16-14 | 30 | 40.8 | 50 | 68.0 | 70 | 95.2 |
| 7/16-20 | 35 | 47.6 | 55 | 74.8 | 80 | 108.8 |
| 1/2-13 | 50 | 68.0 | 75 | 102.0 | 110 | 149.6 |
| 1/2-20 | 55 | 74.8 | 90 | 122.4 | 120 | 163.2 |
| 9/16-12 | 65 | 88.4 | 110 | 149.6 | 150 | 204.0 |
| 9/16-18 | 75 | 102.0 | 120 | 163.2 | 170 | 231.2 |
| 5/8-11 | 90 | 122.4 | 150 | 204.0 | 220 | 299.2 |
| 5/8-18 | 100 | 136 | 180 | 244.8 | 240 | 326.4 |
| 3/4-10 | 160 | 217.6 | 260 | 353.6 | 386 | 525.0 |
| 3/4-16 | 180 | 244.8 | 300 | 408.0 | 420 | 571.2 |
| 7/8-9 | 140 | 190.4 | 400 | 544.0 | 600 | 816.0 |
| 7/8-14 | 155 | 210.8 | 440 | 598.4 | 660 | 897.6 |
| 1-8 | 220 | 299.2 | 580 | 788.8 | 900 | 1,244.0 |
| 1-12 | 240 | 326.4 | 640 | 870.4 | 1,000 | 1,360.0 |

The guides and ruler furnished below are designed to help you select the appropriate hardware.



Nut, M8

Thread Diameter (mm)

Inside Diameter (in) Threads per inch

Nut, 1/2-16

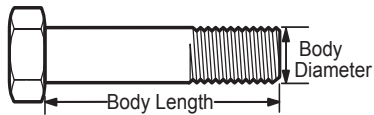

Screw, M8- 1.25 x 25

Thread Diameter (mm) Distance between threads (mm) Body Length (mm)

Body Diameter Threads per inch Body Length (in)

Screw, 1/2- 16 x 2

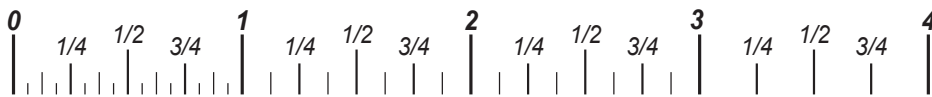

Standard Hardware Sizing

When a washer or nut is identified as 1/2" (M8), this is the *Nominal size*, meaning the *inside diameter* is 1/2 inch (8mm metric thread diameter); if a second number is present it represents the *threads per inch* (distance between threads).

When bolt or capscrew is identified as 1/2 - 16 x 2" (M8 - 1.25 x 50), this means the *Nominal size*, or body diameter is 1/2 inch (8mm metric thread diameter), the second number, 16, represents the *threads per inch*, (*distance between threads*). The final number is the body length of the bolt or screw, 2 inches (50mm).

NOTES

- These torque values are to be used for all hardware excluding: locknuts, self-tapping screws, thread forming screws, sheet metal screws and socket head setscrews.
- Recommended seating torque values for locknuts:
 - for prevailing torque locknuts - use 65% of grade 5 torques.
 - for flange whizlock nuts and screws - use 135% of grade 5 torques.
- Unless otherwise noted on assembly drawings, all torque values must meet this specification.

Common Hardware Types

Hex Head Capscrew

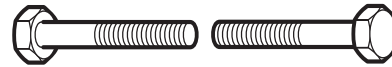

Washer



Carriage Bolt

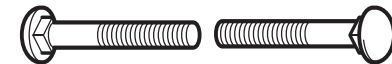

Hex Nut

Wrench & Fastener Size Guide

| | | | | |
|----------------------------------|----------------------------------|----------------------------------|--|---------------------------------|
| | | | | |
| 1/4" Bolt or Nut Wrench—7/16" | 5/16" Bolt or Nut Wrench—1/2" | 3/8" Bolt or Nut Wrench—9/16" | 7/16" Bolt or Nut Wrench (Bolt)—5/8" Wrench (Nut)—11/16" | 1/2" Bolt or Nut Wrench—3/4" |
| M6 Bolt or Nut Wrench—10mm | M8 Bolt or Nut Wrench—13mm | M10 Bolt or Nut Wrench—17mm | M12 Bolt or Nut Wrench—19mm | M14 Bolt or Nut Wrench—22mm |

