

Mfg. No: CMXGWAS020804-00
3,000 PSI Craftsman 49 State

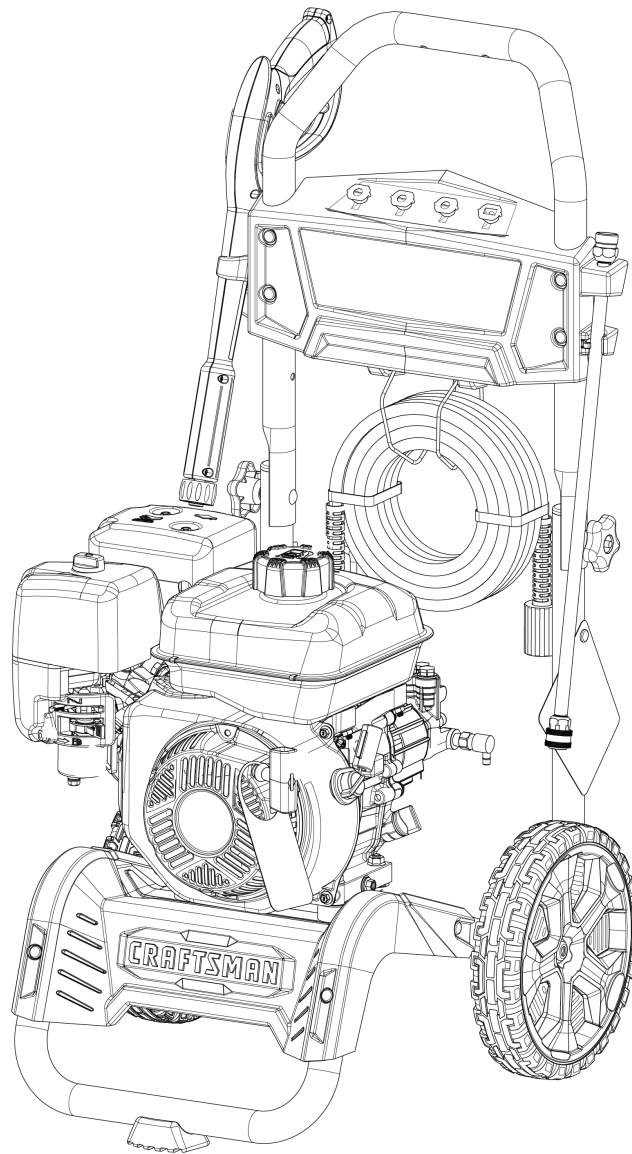

Model Components	Page
Engine Carburetor Fuel Supply.....	4
Engine Ignition Lubrication.....	6
Engine Rewind Exhaust.....	8
Main Unit.....	10
Pump.....	12
Torque Specification Chart.....	14

Not For
Reproduction

Engine Carburetor Fuel Supply

Note: Unless noted otherwise, use the standard torque specifications

Mfg. No: CMXGWAS020804-00

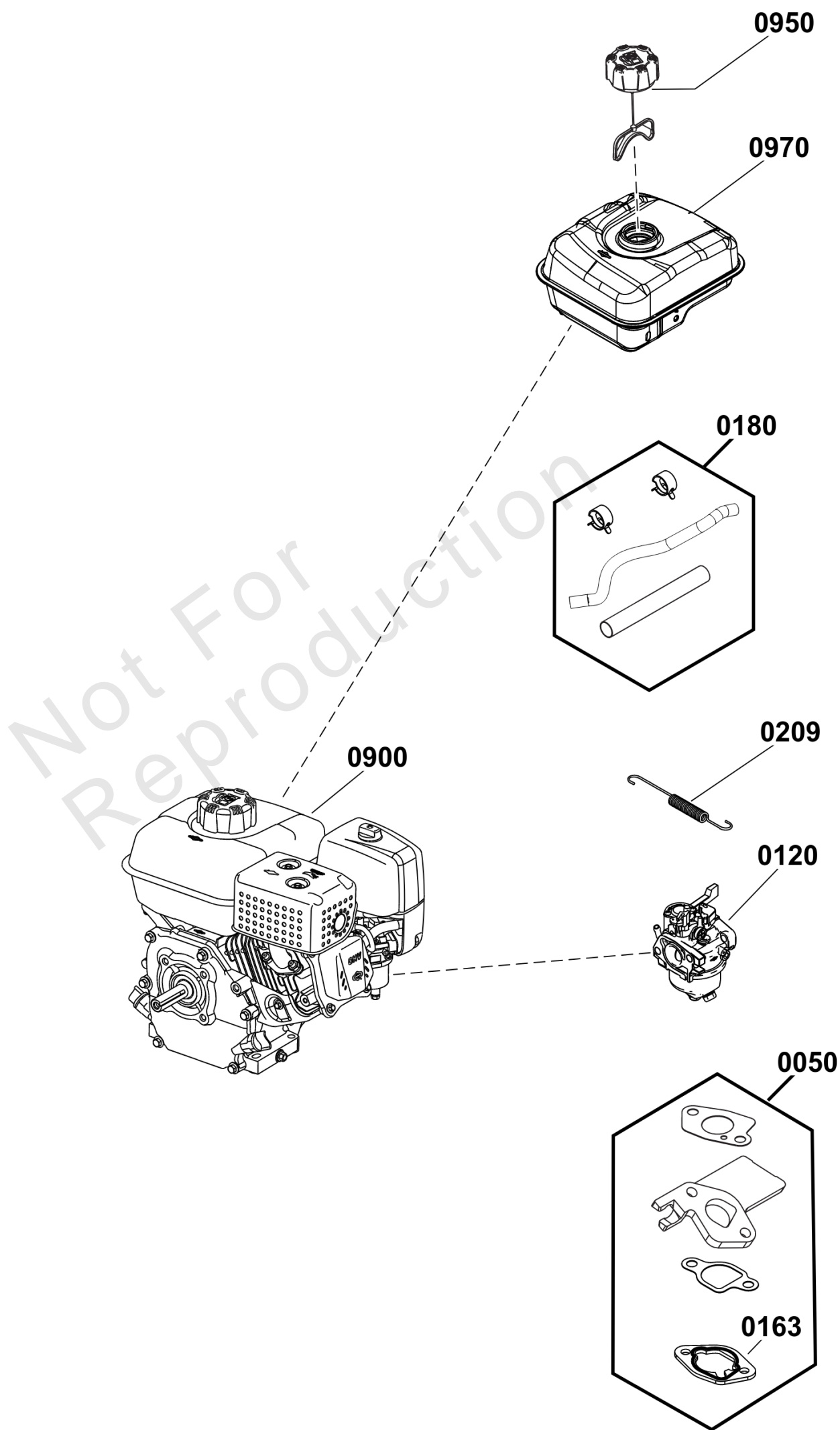

Engine Carburetor Fuel Supply

REF NO	PART NO	QTY	DESCRIPTION
0050	84006542	1	KIT, Carburetor Gasket -(Contains Item 0163)
0120	84007461	1	CARBURETOR
0163	797282	1	GASKET, Air Cleaner
0180	84006544	1	KIT, FUEL HOSE
0209	797691	1	SPRING, Governor
0900	-----	1	ENGINE, 208CC, RED RECOIL -(Complete Engine Not Servicable)
0950	799324	1	CAP, Fuel Tank
0970	84006545	1	TANK, Fuel

Not For Reproduction

Engine Ignition Lubrication

Note: Unless noted otherwise, use the standard torque specifications

Mfg. No: CMXGWAS020804-00

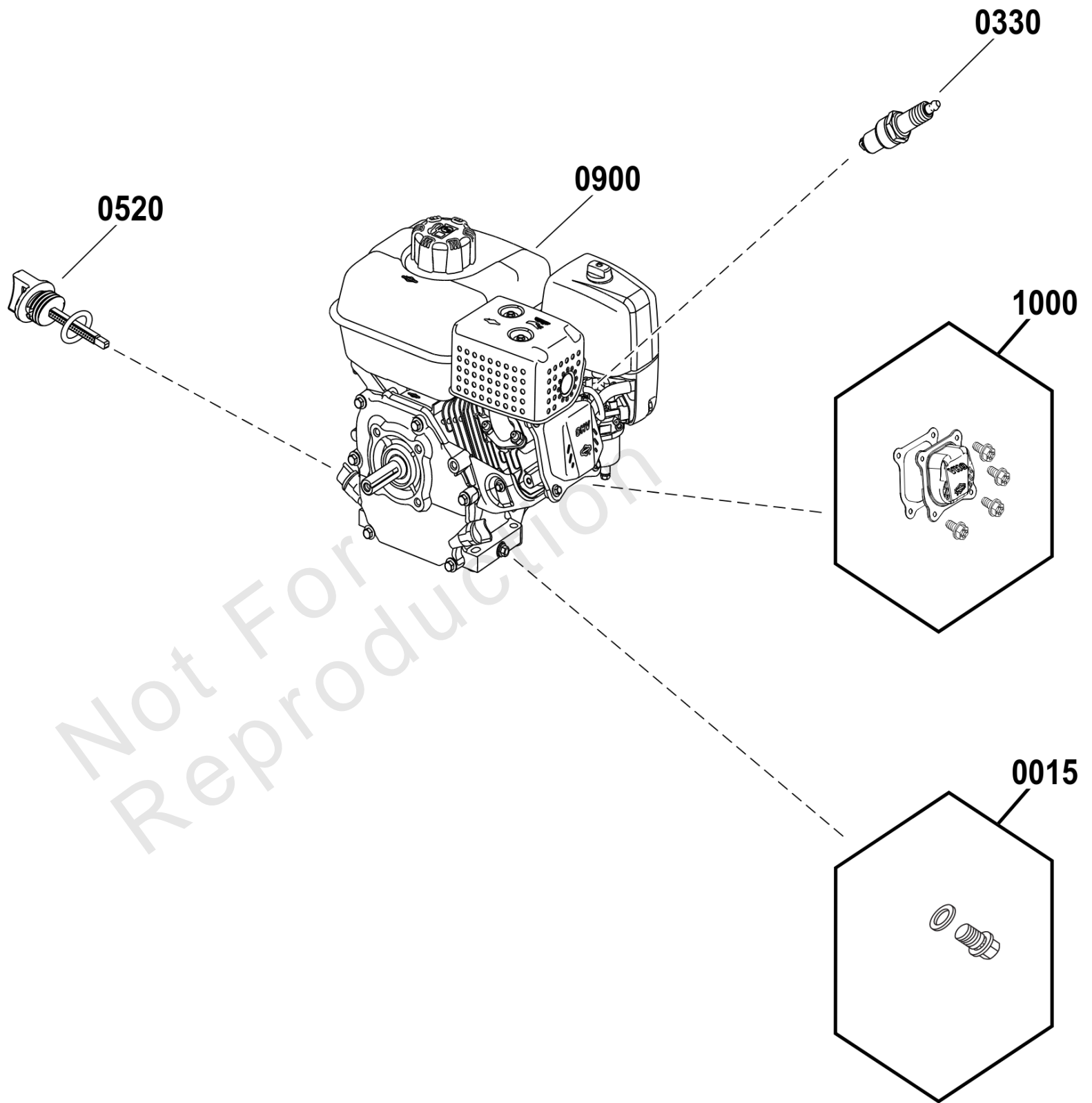

Not For
Reproduction

Engine Ignition Lubrication

REF NO	PART NO	QTY	DESCRIPTION
0015	797215	1	PLUG, Oil Drain -(Includes Washer)
0330	798615	1	PLUG, Spark
0520	84006548	1	DIPSTICK, Oil -(Includes O-ring)
0900	-----	1	ENGINE, 208CC, RED RECOIL -(Complete Engine Not Servicable)
1000	84006549	1	COVER, Rocker

Not For Reproduction

Engine Rewind Exhaust

Note: Unless noted otherwise, use the standard torque specifications

Mfg. No: CMXGWAS020804-00

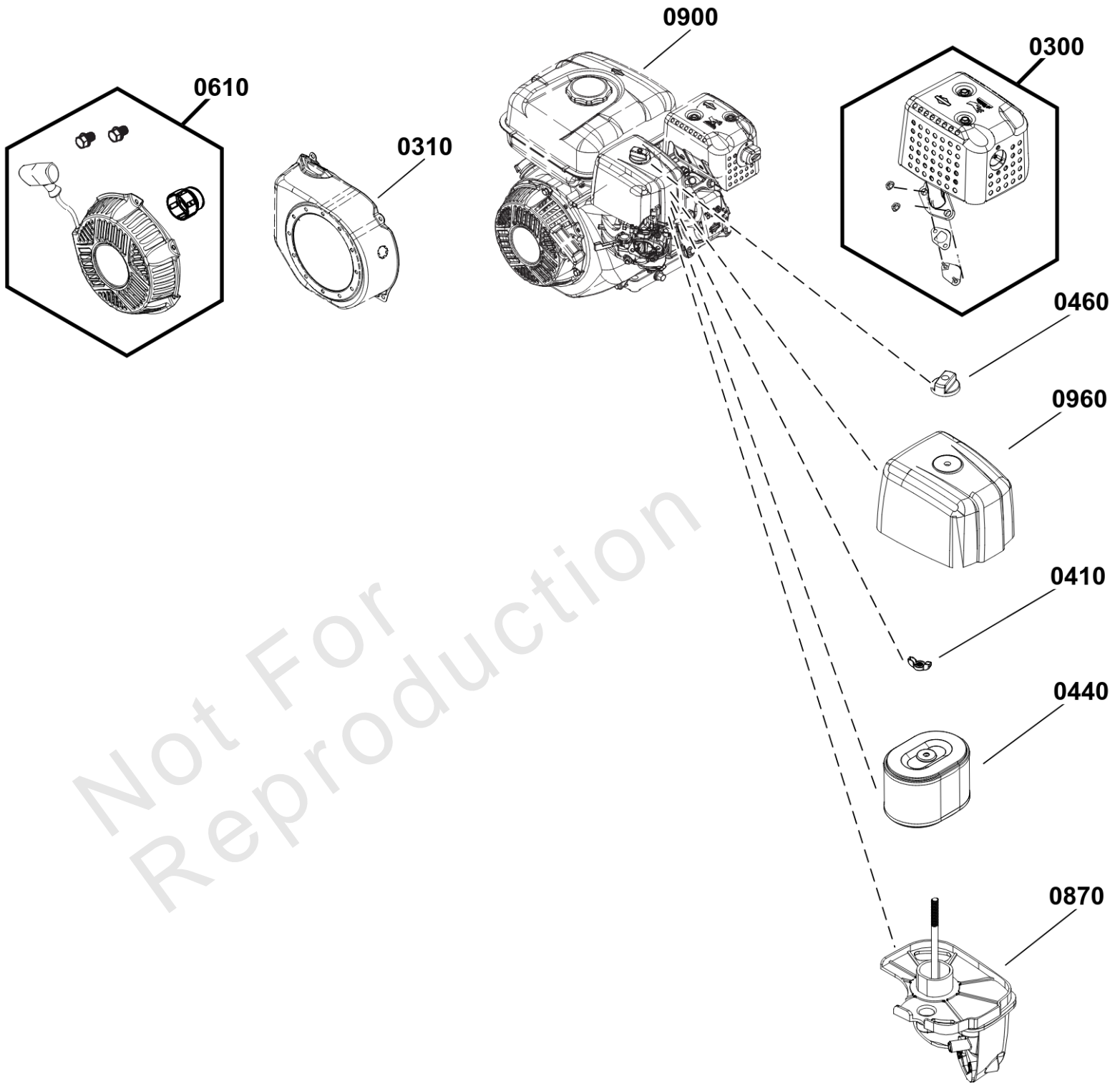

Engine Rewind Exhaust

REF NO	PART NO	QTY	DESCRIPTION
0300	84006546	1	MUFFLER
0310	84006555	1	HOUSING, Blower
0410	799830	1	NUT
0440	594146	1	FILTER, A/C Cartridge
0460	691985	1	KNOB, Air Cleaner Cover
0610	84006547	1	STARTER, Rewind
0870	596293	1	BASE, Air Cleaner
0900	-----	1	ENGINE, 208CC, RED RECOIL -(Complete Engine Not Servicable)
0960	596292	1	COVER, Air Cleaner

Not For Reproduction

Main Unit

Note: Unless noted otherwise, use the standard torque specifications

Mfg. No: CMXGWAS020804-00

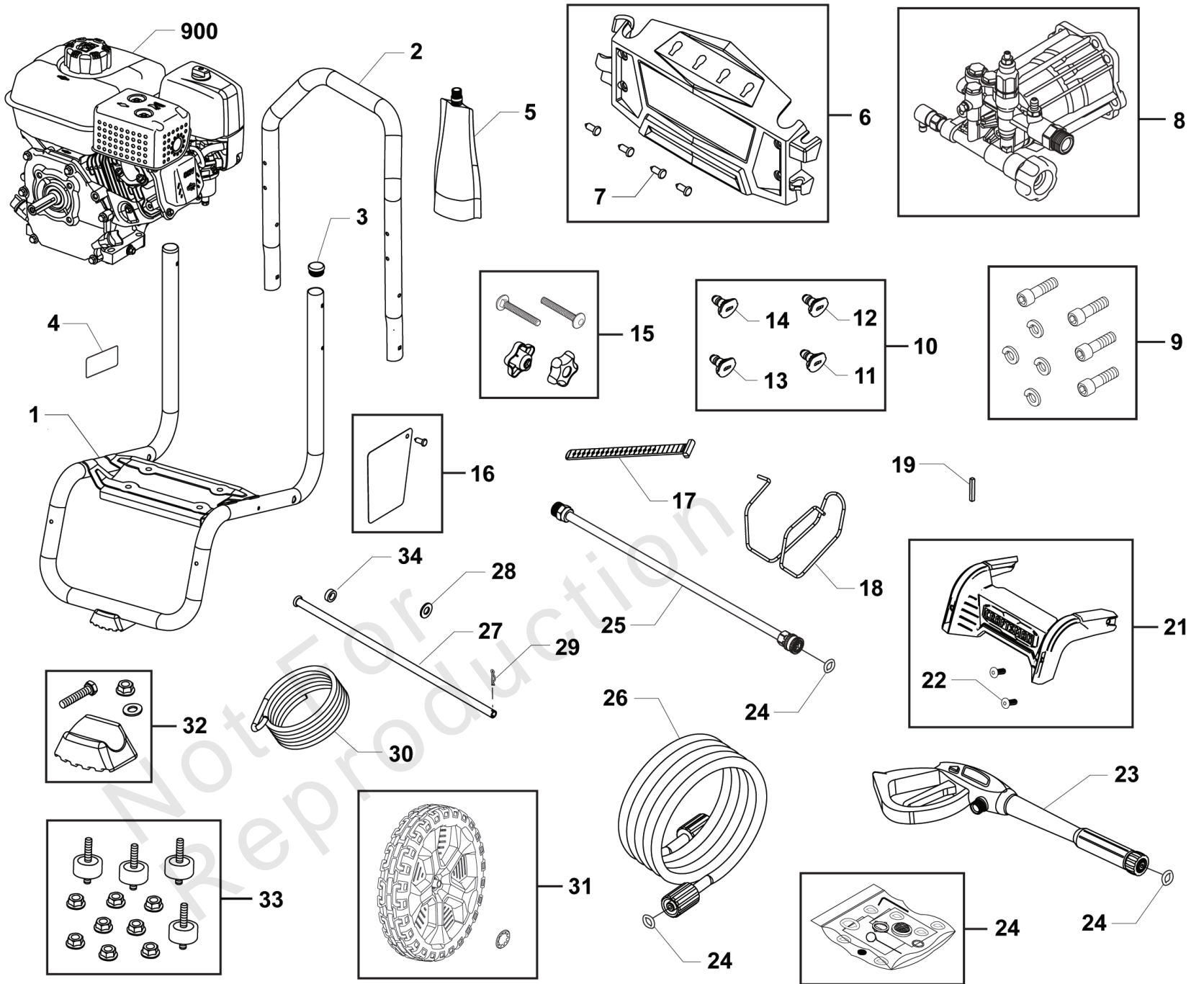

Main Unit

REF NO	PART NO	QTY	DESCRIPTION
1	84006500	1	BASE -(Includes Item 3)
2	84006498	1	HANDLE
3	189332GS	2	PLUG, Hole
4	705851	1	DECAL-Warning Spark
5	100005	1	OIL-4 CYCLE 30W 18OZ.
6	84006845	1	KIT-BILLBOARD
7	B1797GS	4	CLIP
8	84004774	1	PUMP
9	192131GS	1	KIT, Hardware, Pump Mounting
10	208041GS	1	KIT, QC Nozzles
11	195983AJGS	1	NOZZLE, QC RED
12	195983AKGS	1	NOZZLE, QC, Yellow
13	195983AMGS	1	NOZZLE, QC, White
14	198841GS	1	NOZZLE, QC, Black
15	84001720	1	KIT-HANDLE
16	84002531	1	KIT-TAG, WARNING
17	84001717	1	STRAP
18	84006499	1	WIREFORM
19	23139GS	1	KEY
21	84006850	1	KIT-SHROUD
22	195964GS	2	CLIP
23	84002234	1	GUN
24	705001	1	KIT-O-RING
25	706595	1	WAND-QC
26	84006842	1	HOSE
27	84006847	1	AXLE
28	22304GS	2	Washer, Flat 1/2
29	84006849	1	CLIP-RETAINER
30	705076	1	HOSE-CHEMICAL
31	84006502	2	WHEEL -(Includes Item 29)
32	84006505	1	KIT-MOUNT, VIBRATION
33	192134GS	1	KIT, Vibration Mount
34	84006848	1	BUSHING
900	-----	1	ENGINE, 208CC, RED RECOIL -(Not Serviced as a Complete Assembly. Refer to 80098068 Component Groups)
--	6039	1	PUMP Saver -(Optional Accessory - Not Included)
--	6059	1	PERFECT MIX MULTI-PURPOSE WASH -(Optional Accessory - Not Included)
--	6060	1	PERFECT MIX CONCRETE BRICK & TILE CLEANER -(Optional Accessory - Not Included)

Pump

Note: Unless noted otherwise, use the standard torque specifications

Mfg. No: CMXGWAS020804-00

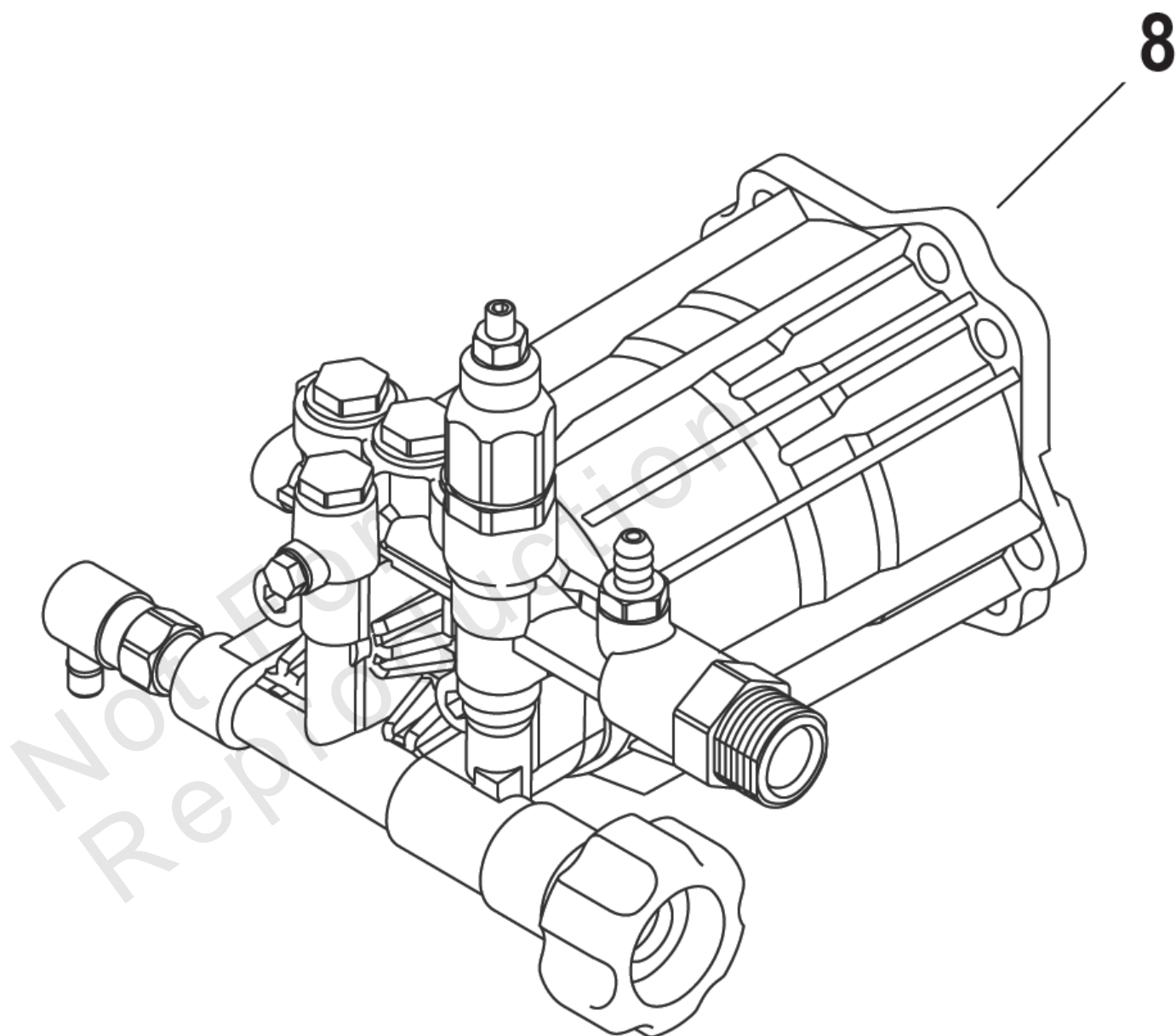

Pump

REF NO	PART NO	QTY	DESCRIPTION
8	84004774	1	PUMP
--	7174403	1	PUMP SAVER -(Optional Accessory - Not Included)
--	7175127	1	PUMP OIL -(Optional Accessory - Not Included)

Not For Reproduction

Hardware Identification & Torque Specifications

Torque Specification Chart								
FOR STANDARD METRIC MACHINE HARDWARE (Tolerance ± 20%)								
Property Class	5.6		8.8		10.9		12.9	
	Class 5.6		Class 8.8		Class 10.9		Class 12.9	
Size Of Hardware	in/lbs	Nm.	in/lbs	Nm.	in/lbs	Nm.	in/lbs	Nm.
	ft/lbs		ft/lbs		ft/lbs		ft/lbs	
M3	5.88	.56	13.44	1.28	19.2	1.80	22.92	2.15
M4	13.44	1.28	30.72	2.90	43.44	4.10	52.56	4.95
M5	26.4	2.50	60.96	5.75	5.97	8.10	7.15	9.7
M6	44.64	4.3	7.3	9.9	10.3	14	12.1	16.5
M7	5.2	7.1	12.1	16.5	16.9	23	19.9	27
M8	7.7	10.5	17.7	24	25	34	29	40
M10	15	21	35	48	50	67	59	81
M12	26	36	61	83	86.2	117	103	140
M14	42	58	101	132	136	185	162	220
M16	64	88	147	200	210	285	250	340
M18	89	121	202	275	287	390	346	470
M20	126	171	290	390	405	550	486	660
M22	169	230	390	530	559	745	656	890
M24	217	295	497	375	708	960	840	1140
M27	320	435	733	995	1032	1400	1239	1680
M30	435	590	995	1350	1401	1900	1681	2280
M33	590	800	1349	1830	1902	2580	2278	3090
M36	759	1030	1740	2360	2441	3310	2935	3980
M39	988	1340	2249	3050	3163	4290	3798	5150

Torque Specification Chart						
FOR STANDARD MACHINE HARDWARE (Tolerance ± 20%)						
Hardware Grade	No Marks		SAE Grade 5		SAE Grade 8	
	SAE Grade 2		SAE Grade 5		SAE Grade 8	
Size Of Hardware	in/lbs	Nm.	in/lbs	Nm.	in/lbs	Nm.
	ft/lbs		ft/lbs		ft/lbs	
8-32	19	2.1	30	3.4	41	4.6
8-36	20	2.3	31	3.5	43	4.9
10-24	27	3.1	43	4.9	60	6.8
10-32	31	3.5	49	5.5	68	7.7
1/4-20	66	7.6	8	10.9	12	16.3
1/4-28	76	8.6	10	13.6	14	19.0
5/16-18	11	15.0	17	23.1	25	34.0
5/16-24	12	16.3	19	25.8	29	34.0
3/8-16	20	27.2	30	40.8	45	61.2
3/8-24	23	31.3	35	47.6	50	68.0
7/16-14	30	40.8	50	68.0	70	95.2
7/16-20	35	47.6	55	74.8	80	108.8
1/2-13	50	68.0	75	102.0	110	149.6
1/2-20	55	74.8	90	122.4	120	163.2
9/16-12	65	88.4	110	149.6	150	204.0
9/16-18	75	102.0	120	163.2	170	231.2
5/8-11	90	122.4	150	204.0	220	299.2
5/8-18	100	136	180	244.8	240	326.4
3/4-10	160	217.6	260	353.6	386	525.0
3/4-16	180	244.8	300	408.0	420	571.2
7/8-9	140	190.4	400	544.0	600	816.0
7/8-14	155	210.8	440	598.4	660	897.6
1-8	220	299.2	580	788.8	900	1,244.0
1-12	240	326.4	640	870.4	1,000	1,360.0

The guides and ruler furnished below are designed to help you select the appropriate hardware.



Nut, M8

Thread Diameter (mm)

Inside Diameter (in) Threads per inch

Nut, 1/2-16



Screw, M8- 1.25 x 25

Thread Diameter (mm) Distance between threads (mm) Body Length (mm)

Body Diameter Threads per inch Body Length (in)

Screw, 1/2- 16 x 2



Standard Hardware Sizing

When a washer or nut is identified as 1/2" (M8), this is the *Nominal size*, meaning the *inside diameter* is 1/2 inch (8mm metric thread diameter); if a second number is present it represents the *threads per inch* (distance between threads).

When bolt or capscrew is identified as 1/2 - 16 x 2" (M8 - 1.25 x 50), this means the *Nominal size*, or body diameter is 1/2 inch (8mm metric thread diameter), the second number, 16, represents the *threads per inch*, (*distance between threads*). The final number is the body length of the bolt or screw, 2 inches (50mm).

NOTES

- These torque values are to be used for all hardware excluding: locknuts, self-tapping screws, thread forming screws, sheet metal screws and socket head setscrews.
- Recommended seating torque values for locknuts:
 - for prevailing torque locknuts - use 65% of grade 5 torques.
 - for flange whizlock nuts and screws - use 135% of grade 5 torques.
- Unless otherwise noted on assembly drawings, all torque values must meet this specification.

Common Hardware Types

Hex Head Capscrew

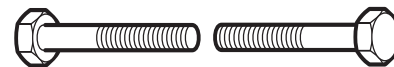

Washer



Carriage Bolt

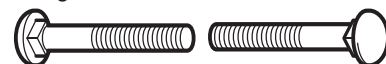

Hex Nut

Wrench & Fastener Size Guide

1/4" Bolt or Nut Wrench—7/16"	5/16" Bolt or Nut Wrench—1/2"	3/8" Bolt or Nut Wrench—9/16"	7/16" Bolt or Nut Wrench (Bolt)—5/8" Wrench (Nut)—11/16"	1/2" Bolt or Nut Wrench—3/4"
M6 Bolt or Nut Wrench—10mm	M8 Bolt or Nut Wrench—13mm	M10 Bolt or Nut Wrench—17mm	M12 Bolt or Nut Wrench—19mm	M14 Bolt or Nut Wrench—22mm

CRAFTSMAN®