

GENERAC®
Portable Products

2500PSI

Pressure Washer Owner's Manual

**Problems?
Questions?**
Before taking your unit
back to the store,
call the pressure washer
helpline at
1-800-270-1408
M-F 8-5 CT

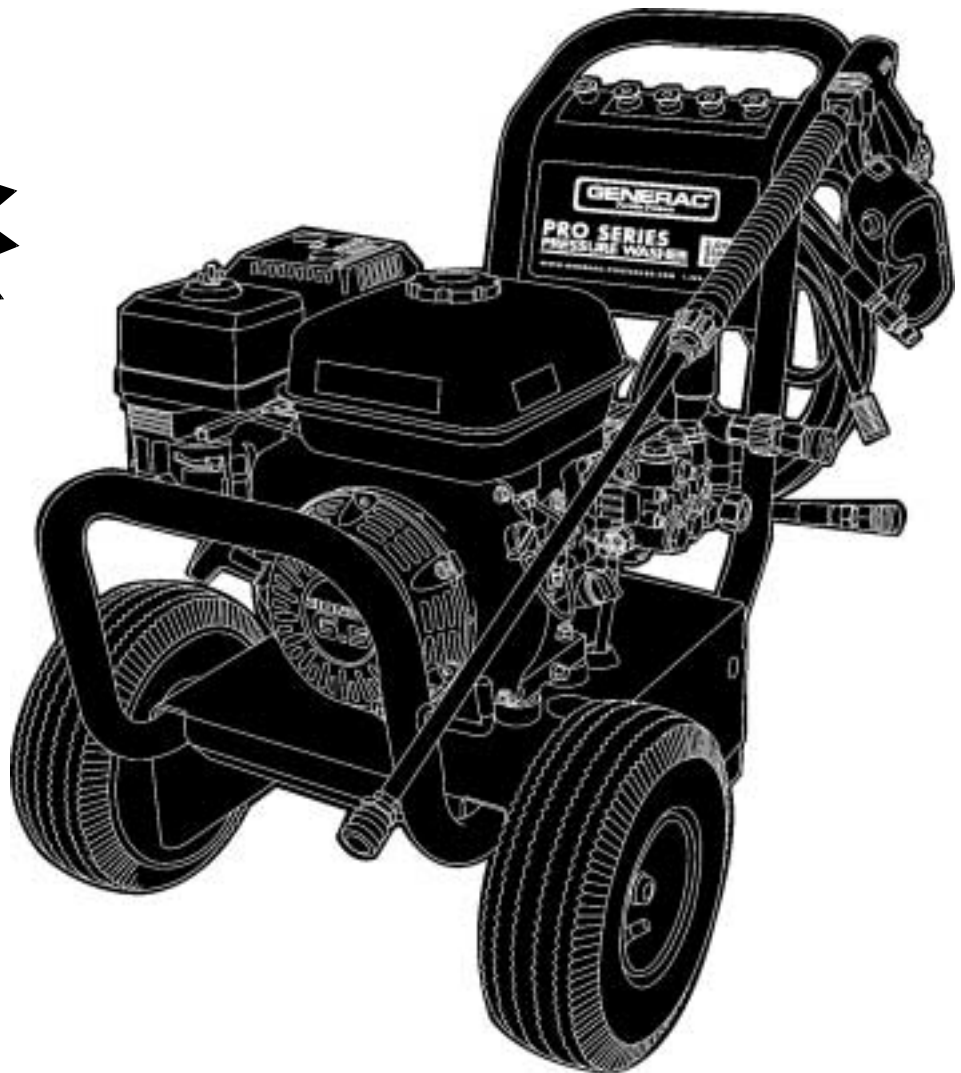

Model No. 1417-1 (2,500 PSI High Pressure Washer) Manual No. 186292 Revision 2 (9/13/2000)

Visit our Generac website: www.generac-portables.com



This is the safety alert symbol. It is used to alert you to potential personal injury hazards. Obey all safety messages that follow this symbol to avoid possible injury or death.



EQUIPMENT DESCRIPTION

CONGRATULATIONS on your purchase of a GENERAC high pressure washer. It has been designed, engineered and manufactured to give you the best possible dependability and performance.

This manual contains information for an high pressure washer that operates at 2,500 PSI at a flow rate of 3.0 gallons per minute. This high quality residential system features large 10" wheels, a pump equipped with an automatic cool down system, a chemical injection system, quick connect nozzles, safety goggles, a heavy duty 50' hose, and more.

Please read and retain this manual. The instructions will enable you to assemble your unit, and maintain your high pressure washer properly.

Every effort has been made to ensure that the information in this manual is both accurate and current. However, Generac reserves the right to change, alter or otherwise improve the product and its documentation at any time without prior notice.

Should you experience any problem you cannot easily fix, call the pressure washer helpline at **1-800-270-1408**.

- Read and observe the safety rules.
- Follow regular schedule in maintaining, caring for and using your high pressure washer.
- For off-season storage, review "Preparing The Unit For Storage" on page 13.

SAFETY RULES

 **CAUTION!** When setting up, transporting, adjusting or making repairs to your high pressure washer, always disconnect the spark plug wire from the spark plug and place the wire where it cannot contact spark plug.

 **DANGER!** Engine exhaust contain DEADLY carbon monoxide gas. This dangerous gas, if breathed in sufficient concentrations, can cause unconsciousness or even death. Operate this equipment only in the open air where adequate ventilation is available.

 **DANGER!** Gasoline is highly FLAMMABLE and its vapors are EXPLOSIVE. **Do Not** permit smoking, open flames, sparks or heat in the vicinity while handling gasoline. Avoid spilling gasoline on a hot engine. Allow unit to cool for 2 minutes before refueling. Comply with all laws regulating storage and handling of gasoline.

Read this manual carefully and become familiar with your pressure washer. Know its applications, its limitations, and any hazards involved.

	WARNING:	
The engine exhaust from this product contains chemicals known to the State of California to cause cancer, birth defects, or other reproductive harm.		

- Locate this pressure washer in areas away from combustible materials, combustible fumes or dust.
- The high pressure equipment is designed to be used with Generac authorized parts **ONLY**. If you use this equipment with parts that **Do Not** comply with minimum specifications, the user assumes all risks and liabilities.
- **Do Not** allow CHILDREN to operate the pressure washer at any time.
- Always be certain the spray gun, nozzles and accessories are correctly attached.
- **Do Not** wear loose clothing, jewelry or anything that may be caught in the starter or other rotating parts.

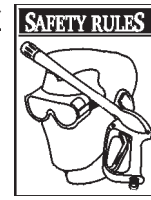

- Before starting the pressure washer in cold weather, check all parts of the equipment and be sure ice has not formed there.
 - **Never** operate units with broken or missing parts, or without protective housing or covers.
 - Use a respirator or mask whenever there is a chance that vapors may be inhaled. Read all instructions with mask so you are certain the mask will provide the necessary protection against inhaling harmful vapors.
 - Always wear eye protection when you use this equipment or when you are in the vicinity where the equipment is in use.
 - The cleaning area should have adequate slopes and drainage to reduce the possibility of a fall due to slippery surfaces.
 - **Do Not** by-pass any safety device on this machine.
 - Operate and store this unit on a stable surface.
 - Some chemicals or detergents may be harmful if inhaled or ingested, causing severe nausea, fainting or poisoning. The harmful elements may cause property damage or severe injury.
 - **Do Not** spray flammable liquids.
 - **Never** allow any part of the body to come in contact with the fluid stream. **Do Not** come in contact with a fluid stream created by leaks in high pressure hose.
 - High pressure spray can cause paint chips or other particles to become airborne.
 - **Do Not** operate the pressure washer above the rated pressure.
 - High pressure spray may damage fragile items including glass. **Do Not** point spray gun at glass when in the jet spray mode.
 - Keep water spray away from electric wiring or fatal electric shock may result.
 - **Never** use a spray gun which does not have a trigger lock or trigger guard in place and in working order.
 - **Never** aim the gun at people, animals or plants. The high pressure stream of water that this equipment produces can pierce skin and its underlying tissues, leading to serious injury and possible amputation.
 - Hold the spray gun firmly in your hand before you start the unit. Failure to do so could result in an injury from a whipping spray gun. **Do Not** leave the spray gun unattended while the machine is running.
 - **Do Not** secure the spray gun in the (open) position.
 - Keep the hose connected to machine or the spray gun while the system is pressurized. Disconnecting the hose while the unit is pressurized is dangerous.
 - **Never** move the machine by pulling on the high pressure hose. Use the handle provided on the unit.
 - High pressure hose can develop leaks from wear, kinking, abuse, etc. Water spraying from a leak is capable of injecting material into skin. Inspect hose each time before using it. Check all hoses for cuts, leaks, abrasions or bulging of cover, or damage or movement of couplings. If any of these conditions exist, replace hose immediately. **Never** repair high pressure hose. Replace it with another hose that exceeds maximum pressure rating of your unit.
 - Check the fuel system for leaks or signs of deterioration, such as chafed or spongy hose, loose or missing clamps, or damaged tank or cap. Correct all defects before operating the pressure washer.
 - Operate engine only at governed speed. Running the engine at excessive speeds increases the hazard of personal injury. **Do Not** tamper with parts which may increase or decrease the governed speed.
 - The muffler and engine heat up during operation and remain hot immediately after shutting it down. Avoid contact with a hot muffler or engine as you could be severely burned.
 - The muffler and air cleaner must be installed and in good condition before operating the pressure washer. These components act as spark arresters if the engine backfires.
- In the State of California a spark arrester is required by law (Section 4442 of the California Public Resources Code). Other states may have similar laws. Federal laws apply on federal lands.
- NOTE:** If you equip the muffler with a spark arrester, it must be maintained in effective working order. You can order a spark arrester through your authorized Honda service dealer.



KNOW YOUR PRESSURE WASHER

Read this owner's manual and safety rules before operating your high pressure washer.

Compare the illustrations with your high pressure washer to familiarize yourself with the location of the controls. Save this manual for future reference.

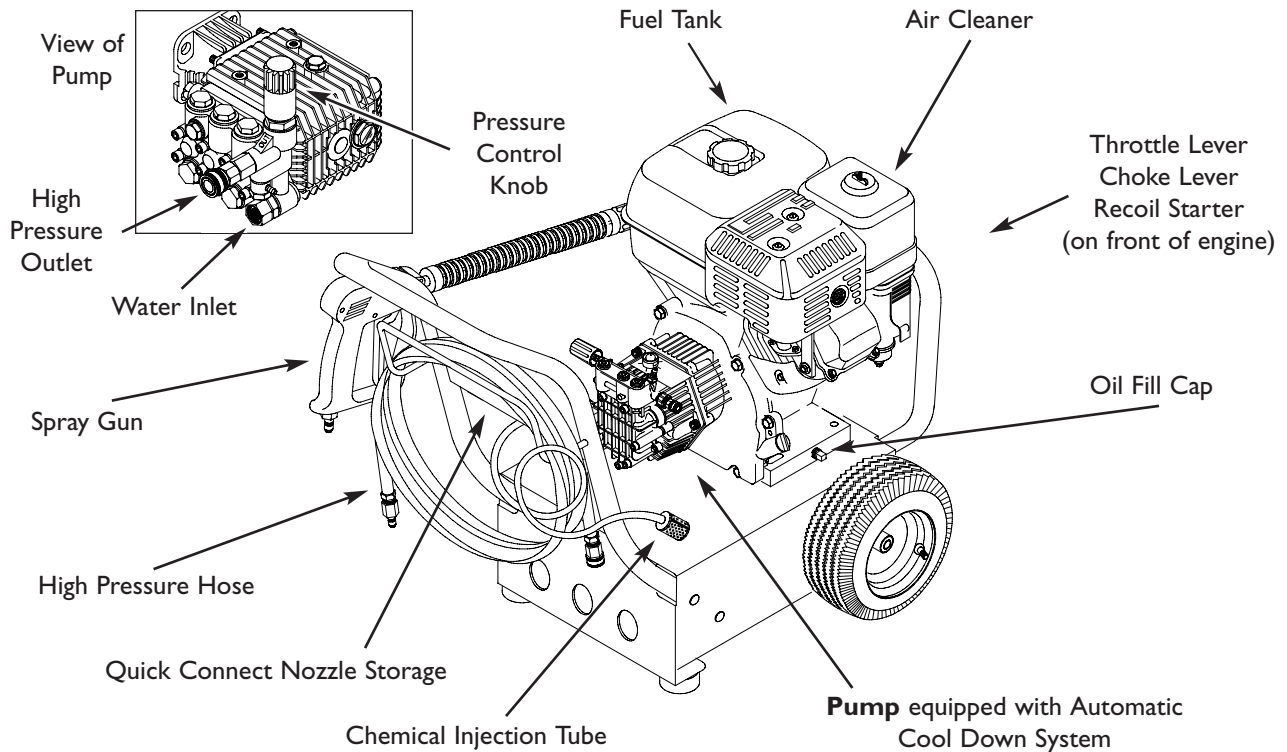

Air Cleaner — Dry type filter element limits the amount of dirt and dust that gets in the engine.

Automatic Cool Down System — Cycles water out of pump when temperature reaches 140°-145°F.

Chemical Injection Tube—Used to siphon chemical from the detergent container to the pump.

Choke Lever — Prepares a cold engine for starting.

Fuel Tank — Fill engine with regular unleaded gasoline here.

High Pressure Hose — Connect one end to water pump and the other end to spray gun. Store hose on hook on the rear of the unit

High Pressure Outlet — Connection for high pressure hose.

Oil Fill Cap —Fill engine with oil here. See engine owner's manual for oil requirements.

Pressure Control Knob — Varies the pressure of the high pressure spray.

Pump — Develops high water pressure.

Quick Connect Nozzle Storage — Place all quick connect nozzles here for ready access.

Recoil Starter — Used for starting the engine manually.

Spray Gun — Controls the application of water onto cleaning surface with trigger. Includes safety latch.

Throttle Lever—Sets engine in starting mode for recoil starter and stops a running engine.

Water Inlet — Connection for garden hose.

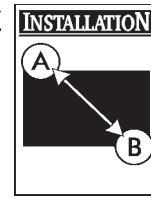

WARNING! Read entire owner's manual before you attempt to assemble or operate your new pressure washer.

REMOVE PRESSURE WASHER FROM CARTON

- Remove the handle and parts box included with pressure washer.
- Slice two corners at the end of carton from top to bottom so the panel can be folded down flat, then remove all packing material.
- Roll pressure washer out of carton.

Carton Contents

Items in the carton include:

- Main Unit
- High Pressure Hose
- Handle
- Parts Box containing:
 - 20oz Oil Bottle
 - Goggles
 - Nozzle Cleaning Kit
 - Bag containing 5 multi-colored nozzles
 - O-Ring Maintenance Kit
 - Owner's Manual
 - Engine Manual
 - Warranty Card
 - Engine Warranty
 - Emissions Control Warranty
 - Spray Gun
 - Nozzle Extension with Quick-Connect Fitting
 - Parts Bag containing:
 - 4 Carriage Bolts
 - 4 Flange Nuts

If any of the above parts are missing or damaged, call the pressure washer helpline at **1-800-270-1408**.

PREPARING PRESSURE WASHER FOR USE

If you have any problems with the assembly of your pressure washer or if parts are missing or damaged, call the pressure washer helpline at **1-800-270-1408**.

To prepare your pressure washer for operation you will need to perform these tasks:

- Remove shipping cap from the pump and install oil dipstick.
- Attach the handle to the main unit.
- Add oil to the engine.
- Add fuel to the fuel tank.
- Connect the high pressure hose to the spray gun and the pump.
- Connect the water supply to the pump.
- Connect nozzle extension to gun.
- Select and install desired nozzle.

Attach Handle to the Pressure Washer

Use either a 13mm wrench or adjustable wrench to attach the handle to the pressure washer.

To attach handle to the pressure washer:

- Slowly tip the pressure washer forward and let it gently rest on the front bumper (Figure 1).

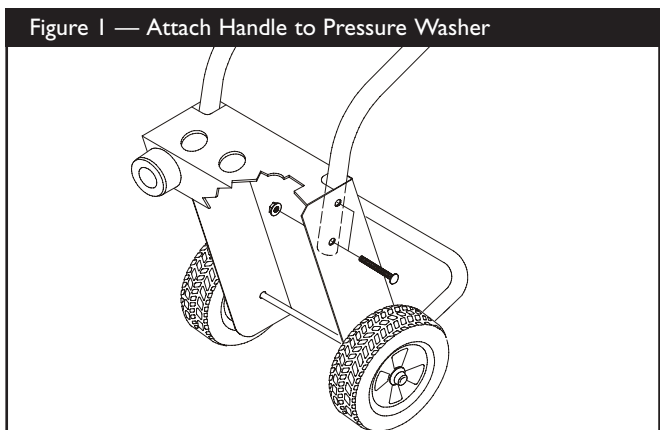

- Align the holes on the handle with the holes on the base.



- Insert the carriage bolts provided to hold the handle in place.
- Secure handle to the pressure washer using the four provided flange nuts.
- Slowly tip the pressure washer back in place and insert the multi-colored nozzles in the spaces provided in the handle.

Install Oil Dipstick on Pump

WARNING! You must remove the shipping cap located on the pump and install the oil dipstick. Failure to do so will void your warranty and damage the pump.

To install the oil dipstick:

- Make sure your unit is on a level surface.
- Remove and discard the shipping cap located on the pump (Figure 2).

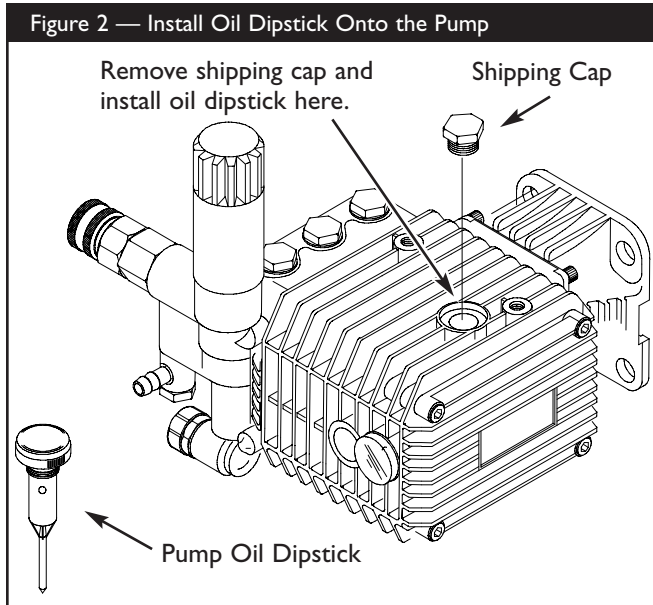

- Install the pump oil dipstick and hand tighten.

Add Engine Oil

IMPORTANT: Any attempt to crank or start the engine before it has been properly serviced with the recommended oil may result in an engine failure.

- Place pressure washer on a level surface.
- Refer to the engine owners manual to add recommended oil to engine.

NOTE: Check oil often during engine break-in. Refer to engine owner's manual for recommendations.

NOTE: The pump is pre-lubricated and sealed, requiring no additional lubrication for the life of the pump.

Add Gasoline

DANGER! Never fill fuel tank indoors, or when engine is running or hot. Do Not smoke when filling fuel tank.

WARNING! Never fill fuel tank completely full. Fill tank to the bottom of the filler neck to provide space for fuel expansion. Wipe away any fuel spillage from engine and equipment before starting.

- Use clean fuel and store in approved, clean covered containers. Use clean fill funnels. **Never** use "stale" gasoline left over from last season or gasoline stored for long periods.
- Clean the area around the fuel fill cap, remove the cap.
- Slowly add **regular UNLEADED gasoline** to fuel tank. Use a funnel to prevent spillage (Figure 3).

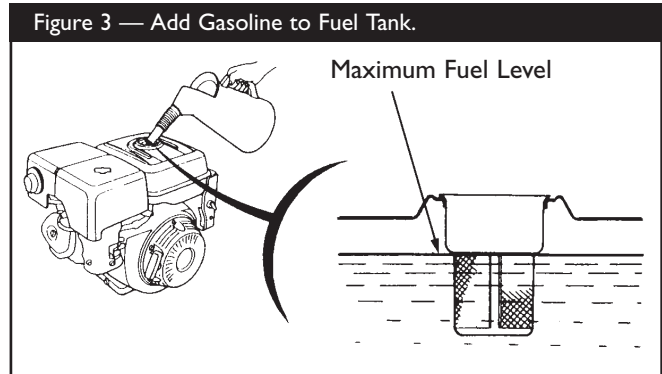

- Install the fuel cap and wipe up any spilled gasoline.

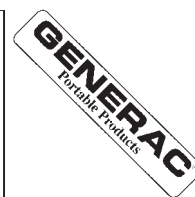
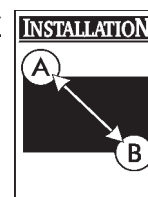

Connect Hose and Water Supply to Pump

IMPORTANT: You must assemble the nozzle extension and attach all hoses before you start the engine. Starting engine without all hoses connected and water supplied will damage the pump.

- Uncoil high pressure hose and attach quick connect end of hose to the base of the spray gun (Figure 4). Pull down on the collar of the quick connect, slide onto the gun and let go of collar. Tug on hose to be sure of a tight connection.

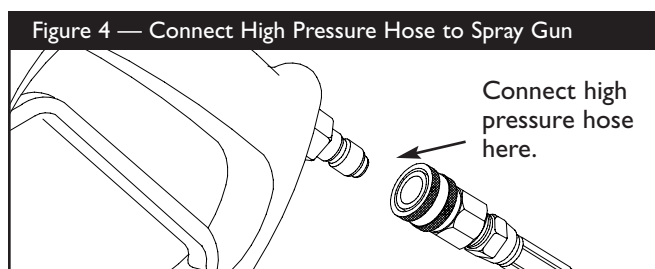

- Attach the other end of the high pressure hose to the high pressure outlet on the pump (Figure 5). Pull down on the collar of the quick connect, slide onto the pump and let go of collar. Pull on hose to be sure of a tight connection.

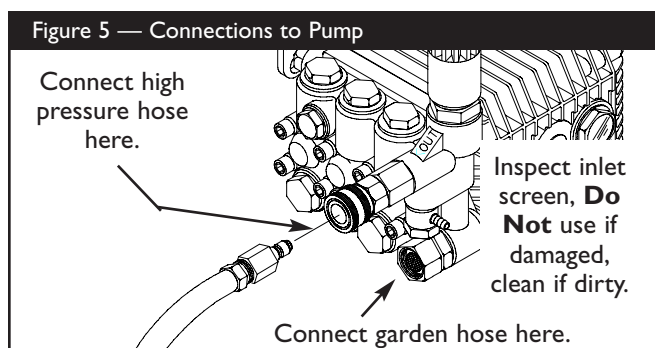

- Before you connect your garden hose to the water inlet, inspect the inlet screen (Figure 5). Clean the screen if it contains debris or have it replaced if damaged. **DO NOT RUN THE PRESSURE WASHER IF THE SCREEN IS DAMAGED.**
- Run water through your garden hose for 30 seconds to clean out any debris.
- Connect the garden hose to the water inlet. Tighten by hand (Figure 5).

WARNING! There **MUST** be at least ten feet of unrestricted garden hose between the pressure washer inlet and any flow shut off device, such as a ‘Y’ shut-off connector or other convenience-type water shut-off valve. Damage to pressure washer resulting from disregarding this warning will not be covered by the warranty.

- Turn **ON** the water.
- Squeeze the trigger on the gun until you have a steady stream of water to purge the pump system of air and impurities.

CAUTION! Before starting the pressure washer, be sure you are wearing adequate eye protection.

- Attach the nozzle extension to the spray gun. Tighten by hand (Figure 6).

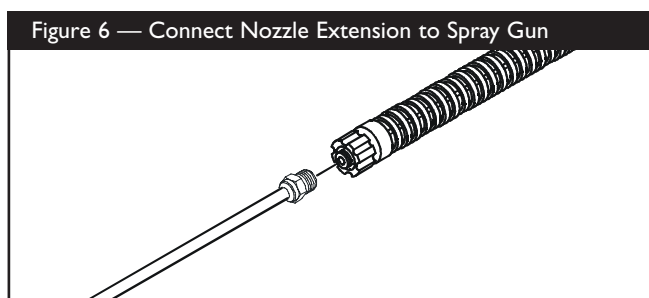

CHECKLIST BEFORE STARTING ENGINE

Review the assembly to ensure you have performed all of the following.

- Replace shipping cap on pump with oil dipstick.
- Check to make sure that there are no kinks, cuts, or damage to the high pressure hose.
- Check that oil has been added to the proper level in the engine crankcase.
- Add the proper gasoline to fuel tank.
- Provide a water supply of adequate flow (not to exceed 140°F).
- Be sure to read the “Safety Rules” and “Preparing Pressure Washer For Use” sections before using the pressure washer.



HOW TO USE YOUR PRESSURE WASHER

If you have any problems operating your pressure washer, please call the pressure washer helpline at **1-800-270-1408**.

How to Start Your Engine

The best way to start your engine-powered pressure washer for the first time is to follow these instructions step-by-step. This starting information also applies whenever you start the engine after you have let the pressure washer sit idle for at least a day.

- Place the pressure washer in an area close enough to an outside water source that can flow at a rate of 3.3 gallons per minute or more.
- Make sure the unit is in a level position.
- Check that the high pressure hose is tightly connected to the spray gun and to the pump. See “Preparing Pressure Washer for Use” on page 5.
- Connect the garden hose to the water inlet on the pressure washer pump and turn on the water.

WARNING! Do **Not** run the pump without the water supply connected and turned on. You must follow this caution or the pump will be damaged.

- Squeeze the trigger on the spray gun (make sure the nozzle is in low pressure mode) to relieve the air pressure caused by turning ON the water. Water will discharge from the gun in a thin stream. Hold the trigger until a steady stream of water appears. This will make it easier to pull start the engine. Release the trigger.
- Apply the safety latch to the spray gun trigger.

- Move the fuel valve to the “On” position (Figure 7).

Figure 7 — Fuel Valve

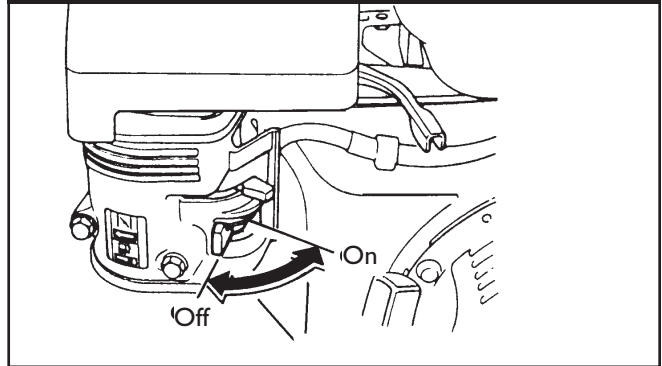

- Move the throttle lever to the “Fast” position (Figure 8).

Figure 8 — Throttle Positions

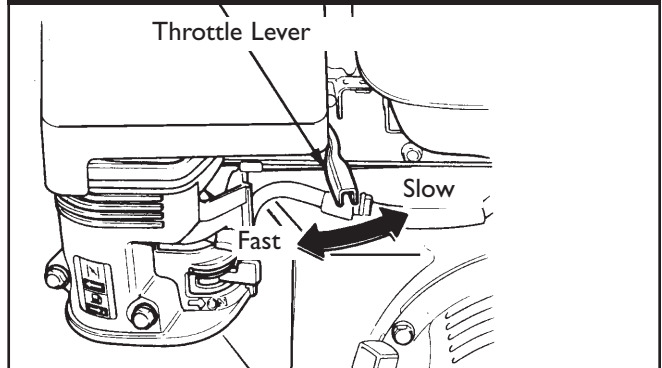

- **To start a cold engine**, move the choke lever to the “Closed” position. **To restart a warm engine**, leave the choke lever in the “Open” position (Figure 9).

Figure 9 — Choke Positions

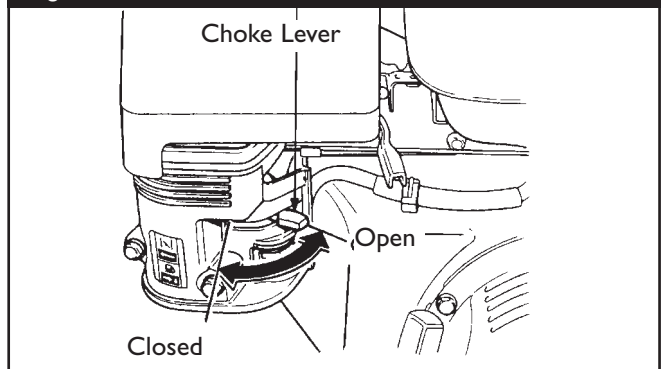



- Set the engine switch to the “On” position (Figure 10).

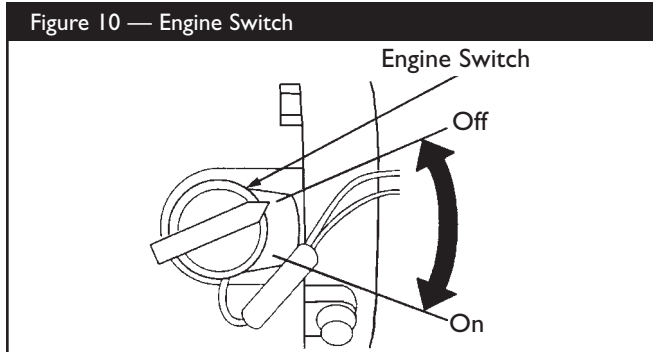

- Grasp starter grip and pull slowly until you feel some resistance. Then pull cord out with rapid full arm stroke. Let rope return slowly. **Do Not** let rope “snap back” against starter.
- If the choke lever has been moved to the “Closed” position to start the engine, gradually move it to the “Open” position as the engine warms up.

How to Stop Your Pressure Washer

- Move the throttle lever to the “Slow” position.
- Wait for the engine to idle down.
- Move the engine switch to the “Off” position.
- Simply shutting off the engine will not release pressure in the system. **Squeeze trigger on the spray gun to relieve pressure in the hose.**

NOTE: A small amount of water will squirt out when you squeeze the trigger.

How to Use the Nozzles

If you have any problems operating your pressure washer, please call the pressure washer helpline at **1-800-270-1408**.

! DANGER! Never exchange nozzles without locking the safety latch on the trigger.

The quick-connect on the nozzle extension allows you to switch between five different nozzles. The nozzles vary the spray pattern as shown below (Figure 11).

Follow these instructions to change nozzles:

- Engage the safety latch on the spray gun.
- Pull back the collar on the quick-connect and pull the current nozzle off. Store the nozzle in the space provided on the control panel.

NOTE: For a more gentle rinse, select the white 40° or green 25° nozzle. To scour the surface, select the yellow 15° or red 0° nozzle. To apply chemical, select the black nozzle.

- Pull back on the collar; insert the new nozzle and release the collar. Tug on the nozzle to make sure it is securely in place.
- For most effective cleaning, keep the spray nozzle between 8 to 24 inches away from the cleaning surface. If you get the spray nozzle too close, you may damage the cleaning surface.

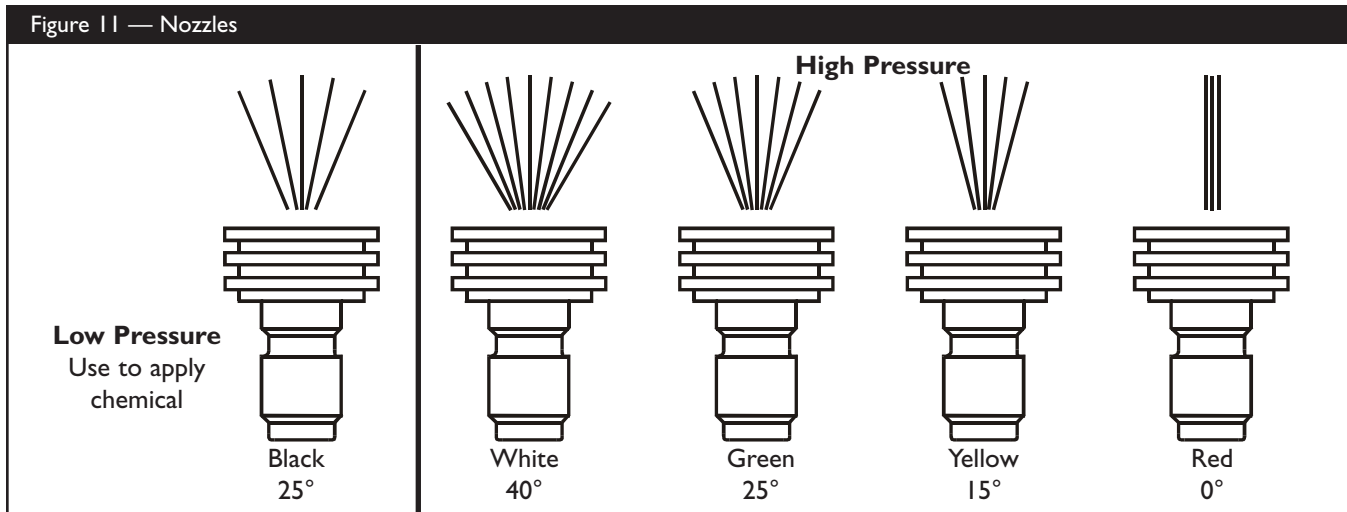



Cleaning and Applying Chemical

WARNING! You must **attach all hoses** before you start the engine. Starting the engine without all the hoses connected and without the water turned ON will damage the pump.

IMPORTANT: Use soaps designed specifically for pressure washers. Household detergents could damage the pump.

To apply detergent follow these steps:

- Review the use of the nozzles.
- Prepare the detergent solution as required by the manufacturer.
- Place the small filter of the chemical injection tube into the detergent container.

CAUTION! Keep the chemical injection tube from coming in contact with the hot muffler.

- Make sure the black nozzle is installed.

NOTE: Detergent cannot be applied with the high pressure nozzles (White, Green, Yellow, or Red).

- Make sure the garden hose is connected to the water inlet. Check that the high pressure hose is connected to the spray gun and the pump and start the engine.
- Apply the detergent to a dry surface, starting at lower portion of area to be washed and work upward, using long, even, overlapping strokes. **Do Not** allow the detergent to dry on. This will prevent streaking.
- Allow the detergent to soak in between 3–5 minutes before washing and rinsing. Reapply as needed to prevent surface from drying.

Pressure Washer Rinsing

WARNING! Be extremely careful if you must use the pressure washer from a ladder, scaffolding or any other relatively unstable location. Hose water pressure builds as you climb. When you press the trigger, the recoil from the initial spray can be very strong. The high pressure spray could cause you to fall if you are too close to the cleaning surface.

After you have applied detergent, scour the surface and rinse it clean as follows:

- Apply safety latch to spray gun.
- Remove the black chemical nozzle from the nozzle extension.
- Select and install the desired high pressure nozzle following the instructions “How to Use the Nozzles” on page 9.
- Keep the spray gun a safe distance from the area you plan to spray.
- Increase or decrease spray pressure by turning the pressure control knob counterclockwise or clockwise respectively (Figure 12). Use lower pressure to wash items such as a car or boat. Use higher pressure to strip paint and degrease driveways.

Figure 12 — Pressure Control Knob

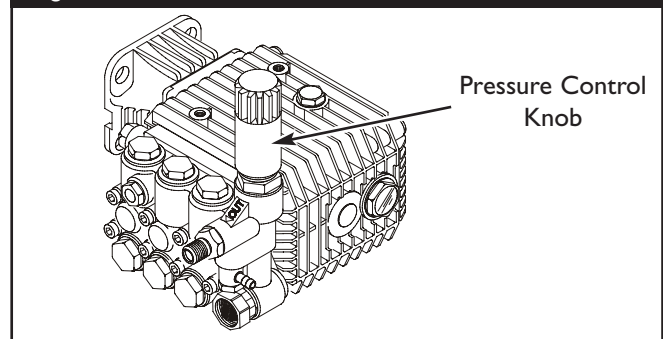

- Apply a high pressure spray to a small area and then check the surface for damage. If no damage is found, you can assume it is okay to continue cleaning.
- Start at the top of the area to be rinsed, working down with same overlapping strokes as you used for cleaning.

Automatic Cool Down System (also known as Thermal Relief)

If you run the engine on your pressure washer for 3–5 minutes without pressing the trigger on the spray gun, circulating water in the pump can reach a temperature between 140–145°F. When the water reaches this temperature, the automatic cool down system engages and cools the pump by **discharging the warm water onto the base and ground**. This system prevents internal damage to the pump.

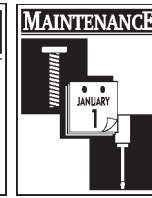

SPECIFICATIONS

- Outlet Pressure** 2,500 PSI
- Flow Rate** 3.0 gallons per minute (gpm)
- Detergent** Use detergent approved for pressure washers
- Water Supply Temperature** Not to exceed 140°F
- Automatic Cool Down System** Will cycle when water reaches 140°-145°F

GENERAL MAINTENANCE RECOMMENDATIONS

The high pressure washer warranty does not cover items that have been subjected to operator abuse or negligence. To receive full value from the warranty, the operator must maintain the high pressure washer as instructed in this manual.

- Some adjustments will need to be made periodically to properly maintain your high pressure washer.
- All adjustments in the Maintenance section of this manual should be made at least once each season.
- Once a year you should clean or replace the spark plug and clean or replace the air filter and check the gun and nozzle extension assembly for wear. A new spark plug and clean air filter assure proper fuel-air mixture and help your engine run better and last longer.

Before Each Use

- Check engine oil level.
- Check water inlet screen for damage.
- Check high pressure hose for leaks.
- Check chemical injection tube and filter for damage.
- Check gun and nozzle extension assembly for leaks.
- Rinse out garden hose to flush out debris.

PRESSURE WASHER MAINTENANCE

Check and Clean Inlet Screen

Examine the screen on the water inlet. Clean it if the screen is clogged or replace it if screen is damaged.

Check High Pressure Hose

The high pressure hose can develop leaks from wear, kinking, or abuse. Inspect the hose each time before using it. Check for cuts, leaks, abrasions or bulging of cover, damage or movement of couplings. If any of these conditions exist, replace the hose immediately.



DANGER! Water spraying from a leak is capable of injecting material into skin. Inspect hose each time before using it. **Never** repair a high pressure hose. Replace it with another hose that exceeds the maximum pressure rating of your pressure washer.

Check Gun and Nozzle Extension

Examine the hose connection to the gun and make sure it is secure. Test the trigger by pressing it and making sure it springs back into place when you release it. Put the safety latch in the on position and test the trigger. You should not be able to press the trigger.

Check In-Line Filter

Refer to Figure 13 and service the in-line filter if it becomes clogged, as follows:

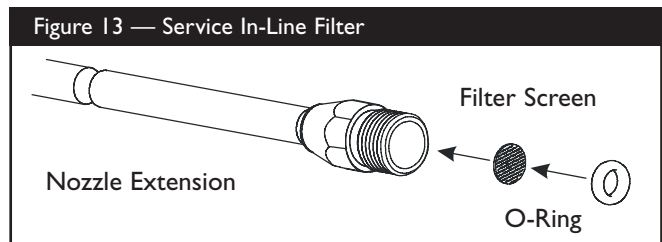

1. Detach gun and nozzle extension from high pressure hose. Detach nozzle extension from gun and remove o-ring and screen from nozzle extension. Flush the screen, gun, and nozzle extension with clean water to clear debris.

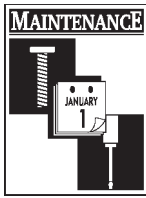

2. If the screen is damaged, the o-ring kit contains a replacement in-line filter screen and an o-ring. If undamaged, reuse screen.
3. Place the in-line filter screen into the threaded end of the nozzle extension. Direction does not matter. Push the screen in with the eraser end of a pencil until it rests flat at the bottom of the opening. Take care to not bend the screen.
4. Place the o-ring into the recess. Push the o-ring snugly against the in-line filter screen.
5. Assemble the nozzle extension to the spray gun, as described earlier in this manual.

Check Chemical Injection Tube

Examine the filter on the detergent hose and clean if clogged. The tube should fit tightly on the barbed fitting. Examine the tube for leaks or tears. Replace the filter or tube if either is damaged.

Purge Pump of Air and Contaminants

To remove the air from the pump, follow these steps:

- Set up the pressure washer as described in “How To Use Your Pressure Washer” on page 8.
- Connect the water supply and turn water on.
- Remove the nozzle extension from the gun.
- Pull the trigger on the gun and hold.

To remove the contaminants from the pump, follow these steps:

- Set up the pressure washer as described in “How To Use Your Pressure Washer” on page 8.
- Connect the water supply and turn water on.
- Remove the nozzle extension from the gun.
- Start the engine according to instructions in “How To Use Your Pressure Washer” on page 8.
- Squeeze the trigger on the gun and hold.
- When the water supply is steady and constant, engage the safety latch and refasten the nozzle extension.

Cleaning Chemical Injection Tube

If you have used the chemical injection tube you must flush it with clean water before stopping the engine.

- Place the chemical injection tube in a bucket full of clean water.
- Flush for 1–2 minutes.
- Shut off the engine.

IMPORTANT: Simply shutting OFF engine will not release pressure in the system. When the engine has stopped, squeeze the trigger on the gun to relieve the pressure in the hose.

Nozzle Maintenance

If a nozzle becomes restricted or clogged with dirt or foreign materials, a pulsing sensation caused by excessive pump pressure may occur during use.

Immediately clean a clogged or partially restricted nozzle with the kit included with your pressure washer by following these instructions:

- Shut off the engine and turn off the water supply.
- Disengage the safety latch and pull the trigger on the spray gun. Hold until all water is purged from the unit. Engage the safety latch on the spray gun.
- Separate the nozzle extension from the spray gun.
- Twist nozzle to stream setting.
- Remove nozzle from the end of the nozzle extension using a 2 mm or 5/64 allen wrench (included in Nozzle Cleaning Kit).
- Use the wire included in the kit or a small paper clip to free the foreign materials clogging or restricting the nozzle (Figure 14).

Figure 14 — Nozzle Maintenance

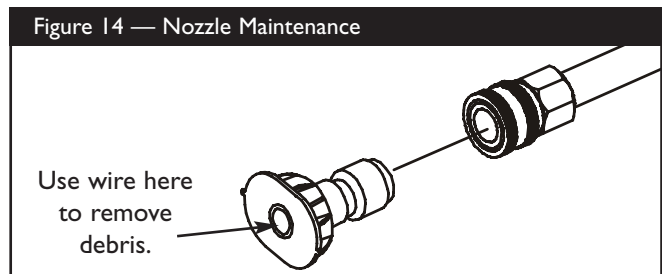

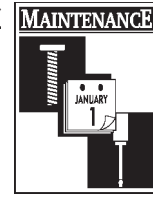

- Remove additional debris by back flushing water supply through nozzle extension. Back flush between 30 to 60 seconds. Twist nozzle extension to stream pattern and move nozzle from low to high pressure while flushing.
- Reinstall nozzle into nozzle extension. Do Not overtighten.
- Reconnect the water supply, turn ON the water, and start the engine.
- Reconnect nozzle extension to spray gun.
- Test the pressure washer by operating with nozzle in the high and the low pressure positions.

O-Ring Maintenance

Your pressure washer uses o-rings to keep hose and spray gun connections tight and leak-free. Through the normal operation of your unit, these o-rings may become worn or damaged.

Provided with your pressure washer is an O-Ring Maintenance Kit which includes replacement o-rings, rubber washer and water inlet filter. Refer to the instruction sheet provided in the kit to service your unit's o-rings. Note that not all of the parts in the kit will be used on your unit.

To remove a worn or damaged o-ring:

- Use a small flathead screwdriver to get underneath the o-ring and pry it off.

ENGINE MAINTENANCE

See the engine owner's manual for instructions on how to properly maintain the engine.

PREPARING UNIT FOR STORAGE

Water should not remain in the unit for long periods of time. Sediments of minerals can deposit on pump parts and "freeze" pump action. If you do not plan to use the pressure washer for more than 30 days, follow this procedure:

1. Flush chemical injection tube by placing the filter into a pail of clean water while running pressure washer with the black chemical nozzle. Flush for one to two minutes.
2. Shut off the engine and let it cool, then remove all hoses.
3. Move the throttle lever to the "SLOW" position.
4. Set engine switch to the "OFF" position.



WARNING! Be sure switch is in "OFF" position before you continue. If you start engine without proper water supply connected, you can damage pump.

5. Empty the pump of all pumped liquids by pulling the recoil handle about 6 times. This should remove most of the liquid in the pump.

NOTE: To protect the unit from freezing temperatures, draw RV antifreeze (no alcohol) into the pump by pouring the antifreeze into a 3-foot section of garden hose connected to inlet adapter and pulling recoil handle twice. This process is also recommended to avoid lime/calcium build-up in the pump during longer-term storage.

6. Store in a clean, dry area.

STORING THE ENGINE

See the engine owner's manual for instructions on how to properly store the engine.

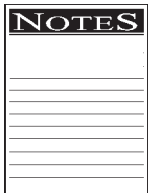

NOTES

A series of horizontal lines providing space for handwritten notes.



TROUBLESHOOTING

Problem	Cause	Correction
Pump has following problems: Failure to produce pressure, erratic pressure, chattering, loss of pressure, low water volume.	<ol style="list-style-type: none"> 1. Low pressure nozzle installed. 2. Water inlet is blocked. 3. Inadequate water supply. 4. Inlet hose is kinked or leaking. 5. Clogged inlet hose strainer. 6. Water supply is over 140°F. 7. Outlet hose is blocked or leaks. 8. Gun leaks. 9. Nozzle is obstructed. 10. Pump is faulty. 	<ol style="list-style-type: none"> 1. Replace with high pressure nozzle. 2. Clear inlet. 3. Provide adequate water flow. 4. Straighten inlet hose, patch leak. 5. Check and clean inlet hose strainer. 6. Provide cooler water supply. 7. Clear blocks in outlet hose. 8. Replace gun. 9. Clean nozzle. 10. Contact Generac service facility.
Detergent fails to mix with spray.	<ol style="list-style-type: none"> 1. Chemical injection tube is not submerged. 2. Chemical filter is clogged. 3. High pressure nozzle attached. 	<ol style="list-style-type: none"> 1. Insert chemical injection tube into detergent. 2. Clean or replace filter/detergent siphoning tube. 3. Use low pressure, black chemical nozzle to apply detergent.
Engine runs good at no-load but "bogs" when load is added.	Engine speed is too slow.	Move throttle control to "FAST" position. If engine still "bogs down" contact Generac service facility.
Engine will not start; or starts and runs rough.	<ol style="list-style-type: none"> 1. Low oil level. 2. Dirty air cleaner. 3. Out of gasoline. 4. Stale gasoline. 5. Spark plug wire not connected to spark plug. 6. Bad spark plug. 7. Water in gasoline. 8. Overchoking. 9. Excessively rich fuel mixture. 10. Intake valve stuck open or closed. 11. Engine has lost compression. 	<ol style="list-style-type: none"> 1. Fill crankcase to proper level. 2. Clean or replace air cleaner. 3. Fill fuel tank. 4. Drain gas tank; fill with fresh fuel. 5. Connect wire to spark plug. 6. Replace spark plug. 7. Drain gas tank; fill with fresh fuel. 8. Open choke fully and crank engine. 9. Contact Honda service facility. 10. Contact Honda service facility. 11. Contact Honda service facility.
Engine shuts down during operation.	<ol style="list-style-type: none"> 1. Out of gasoline. 2. Low oil level. 	<ol style="list-style-type: none"> 1. Fill fuel tank. 2. Fill crankcase to proper level.
Engine lacks power.	Dirty air filter.	Replace air filter.
Engine "hunts" or falters.	Choke is opened too soon.	Move choke to halfway position until engine runs smoothly.

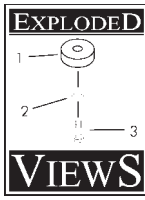

EXPLODED VIEW - UNIT

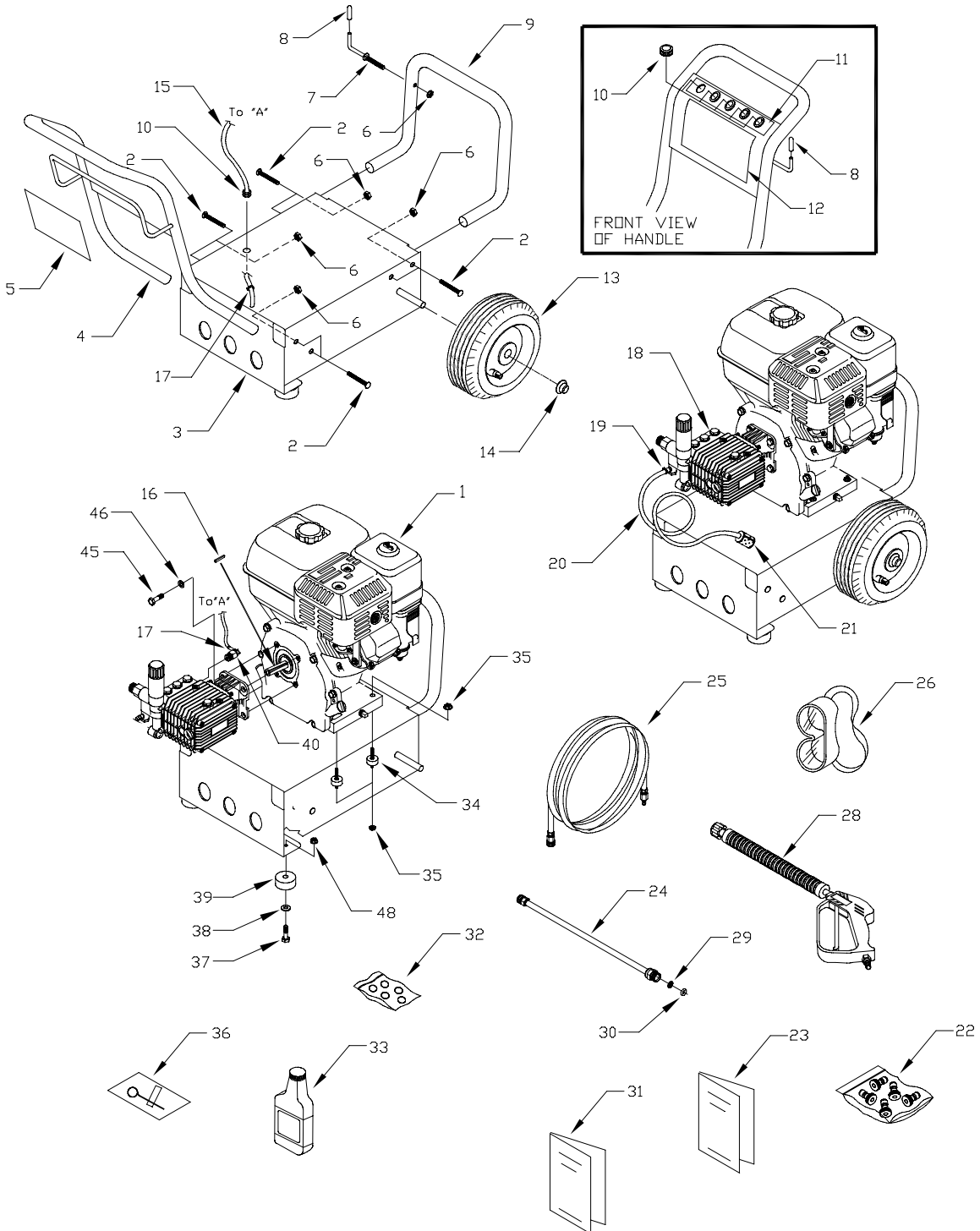

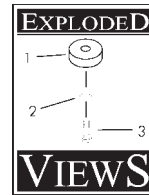

PART LIST – UNIT

Item	Part #	Qty.	Description
1	NSP	1	ENGINE
2	B2043	8	BOLT, 5/16" - 18 x 1-3/4" Carriage
3	BB2226	1	BASE
4	CB3861A	1	HANDLE
5	B4160	1	DECAL, Operating Instructions
6	99583	9	NUT, 5/16" - 18 Hex Flange
7	B2150	1	HOOK, 5/16" Square Neck Gun
8	B2516	2	CAP, Black Vinyl .280"
9	CB3866	1	BUMPER
10	30809	6	GROMMET, 1/8" - 11/16"
11	B4159	1	DECAL, 5 QC Nozzles
12	B5188	1	DECAL, Unit 1417
13	88521	2	ASSEMBLY, Wheel 10" Dia. x 4"
14	75402	2	PUSHNUT, .50"
15	B3107A	1	HOSE, Thermal Relief
16	23139B	1	KEY, 3/16" Square
17	48031B	2	CLAMP, Hose
18	B3169A	1	PUMP, Assy (See pages 20-23)
19	48031G	1	CLAMP, Hose
20	A1040A	1	HOSE, Chemical Inject
21	A1041	1	FILTER, Chemical Hose
22	B4155	1	KIT, Nozzles QC
23	186292	1	MANUAL, Owners
24	B3858	1	ASSY., Wand Ext. with QD
25	B4805	1	HOSE, 3/8" x 50'
26	87815	1	GOGGLES, Safety
28	B1436B	1	GUN, with Molded Grip
29	B4224	1	SCREEN, Gun Inlet
30	97837	1	O-RING, Hi Pressure Trans.
31	B5214	1	MANUAL, Engine
32	B5830	1	KIT, O-Ring Maintenance
33	BB3061B	1	OIL BOTTLE
34	21217	4	MOUNT, Rubber Shock
35	67989	8	NUT, M8 Flange Serrated
36	B2509	1	KIT, Nozzle Cleaning
37	42909	2	HHCS, M8 - 1.25 x 30
38	50190	2	FLAT WASHER, 10GA - .34" x 1"
39	27007	2	VIB MOUNT, Donut Type
45	48614	4	HHCS, 5/16" - 24 x 3/4"
46	92479	4	LOCK WASHER, M8 Ribbed
48	52858	2	NUT, M8 Locking

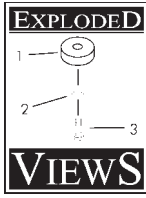

EXPLODED VIEW-PUMP

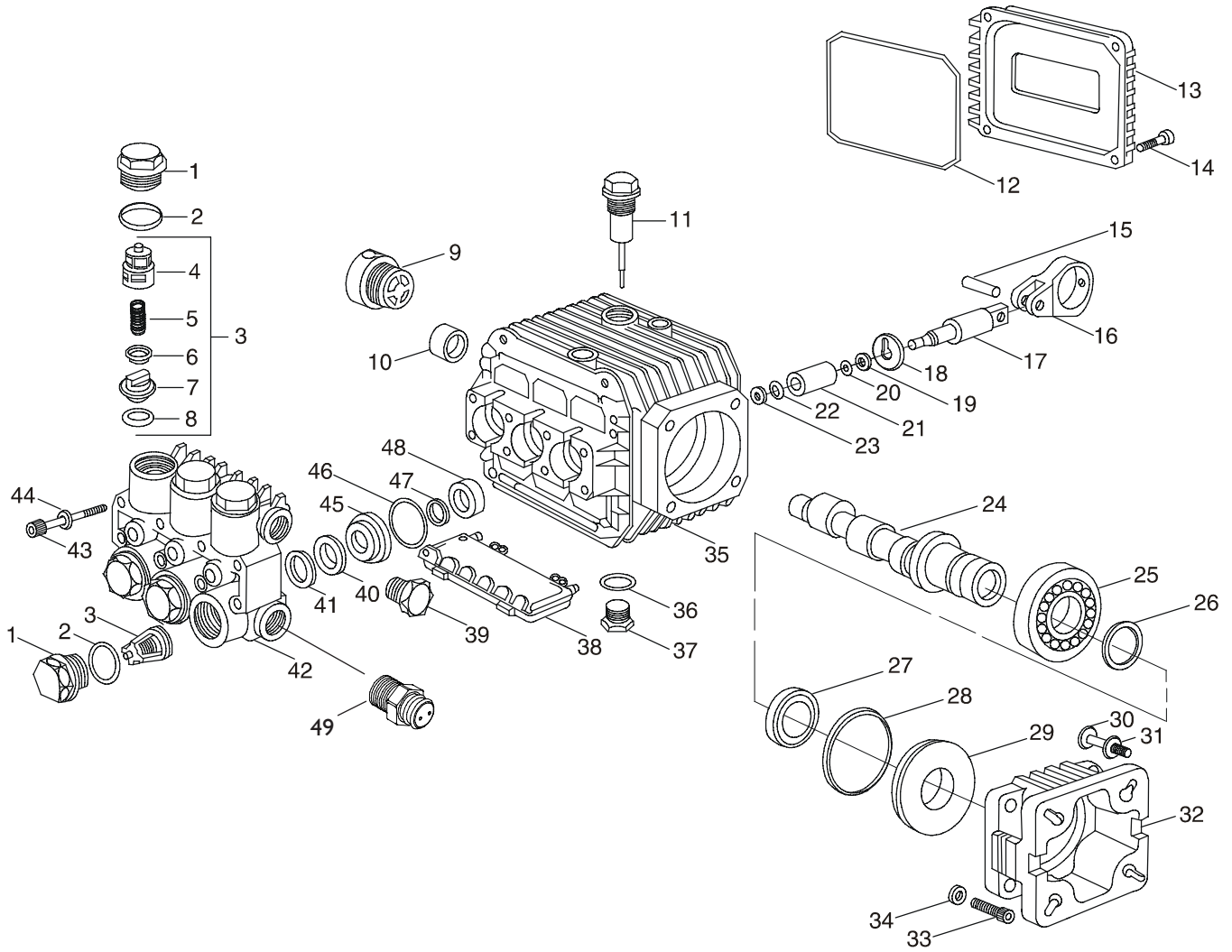

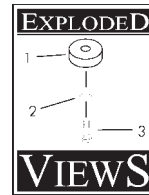

PART LIST-PUMP

Item	Part #	Qty.	Description	Item	Part #	Qty.	Description
0	B3169	1	Complete Pump Assy	26	I3192293P	1	Snap Ring
1	I14B3169	6	Valve Cap	27	I3092293P	1	Oil Seal
2	I0892293P	6	O-Ring	28	I2992293P	1	O-Ring
3	I15B3169	6	*Valve Assy	29	I2892293P	1	Spacer
4	I12B3169	6	*Valve Cage	30	I36B3169	4	Screw
5	I11B3169	6	*Spring	31	I37B3169	4	Washer
6	I10B3169	6	*Screw	32	I38B3169	1	Flange
7	I09B3169	6	*Valve Seat	33	I2692293P	4	Screw
8	I08B3169	6	*Plug	34	I0692293P	4	Washer
9	I1092293P	1	Sight Gauge	35	I0092293P	1	Crankcase
10	I1192293P	1	Needle Bearing	36	I0292293P	1	O-Ring
11	94504	1	Oil Dipstick	37	I0192293P	1	Plug
12	I2092293P	1	Cover, O-Ring	38	I0392293P	1	Protector
13	I1892293P	1	Crankcase Cover	39	I0492293P	1	Plug
14	I2692293P	4	Screw	40	I17B3169	3	*Packing
15	I1792293P	3	Con Rod Pin	41	I16B3169	3	*Head Ring
16	I34B3169	3	Con Rod End	42	I72B3169	1	Brass Manifold
17	I2292293P	3	Piston Guide	43	I0792293P	8	Screw
18	I1692293P	3	Flinger Washer	44	I0692293P	8	Washer
19	I1592293P	3	Back Up Ring	45	I18B3169	1	*Oil Seal
20	I1492293P	3	O-Ring	46	I19B3169	3	*O-Ring
21	I5092293P	3	Piston	47	I20B3169	3	*O-Ring
22	I1392293P	1	Needle Bearing	48	I04B3169	1	*Oil Seal
23	I1292293P	3	Nut	49	B2727	1	Thermal Relief Valve
24	I46B3169	1	Crankshaft				
25	I3292293P	1	Bearing				

* Not Sold Separately

Kit No.	50092294P Valve Kit	500922293P Oil Seal Kit	I92B3169 O-Ring Kit
Items in Kit	8, 7, 6, 5, 4 & (3)	48	45, 46 & 47
Assemblies in Kit	6	3	3
# of Cylinders Kit will service	3	3	3

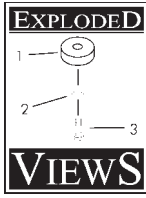

EXPLODED VIEW-UNLOADER

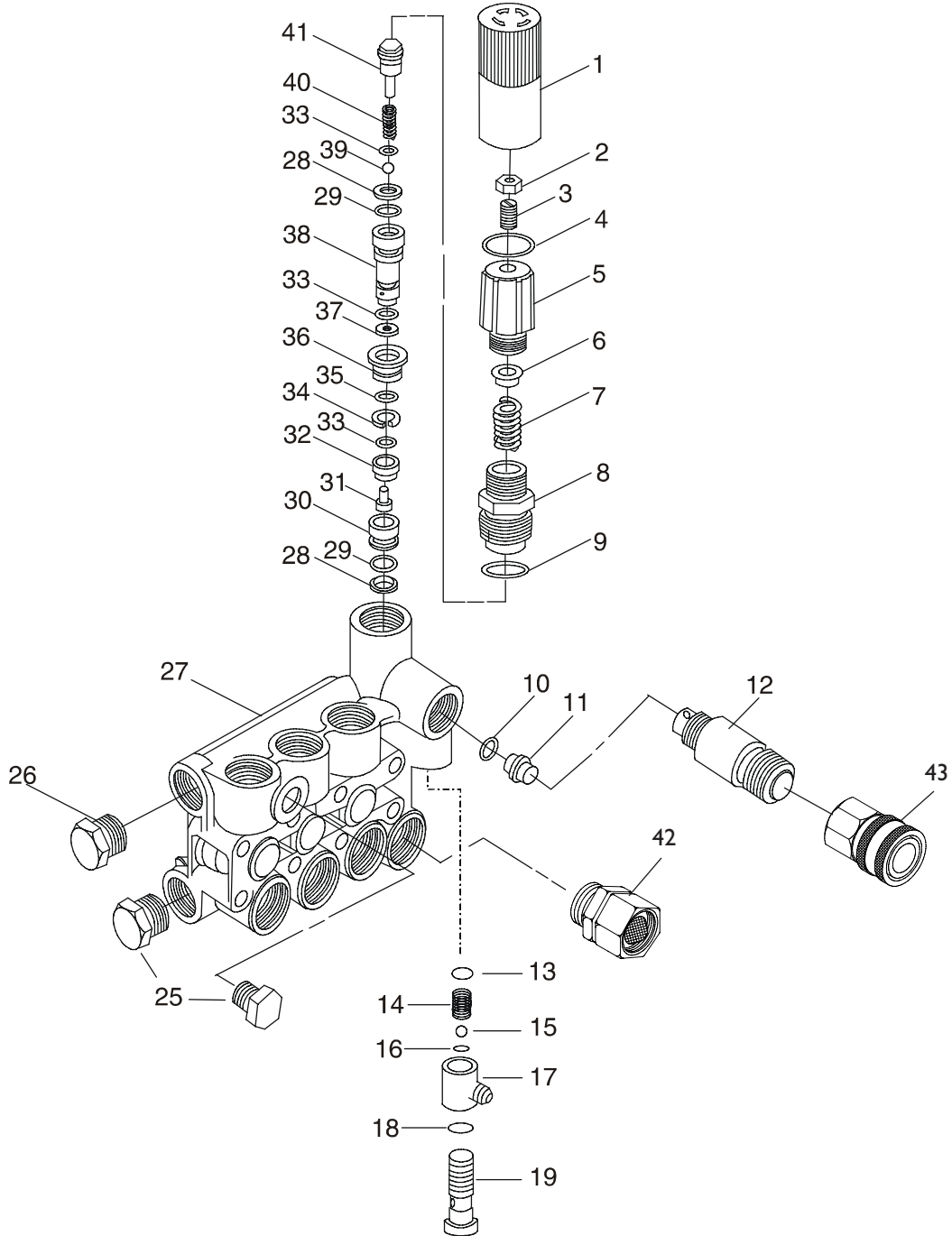

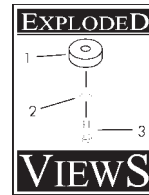

PARTS LIST-UNLOADER

Item	Part #	Qty.	Description	Item	Part #	Qty.	Description
	NSP	1	Complete Unloader Assy.	25	10492293P	2	Cap
1	13492293P	1	Knob	26	10192293P	1	Cap
2	148B3169	1	Nut	27	172B3169	1	UI Manifold
3	149B3169	1	Set Screw	28	160B3169	1	Backup Ring
4	13792293P	1	O-Ring	29	161B3169	2	O-Ring
5	13892293P	1	Pressure Regulator	30	169B3169	1	Valve Seal
6	152B3169	1	Seal	31	168B3169	1	Screw
7	14092293P	1	Spring	32	167B3169	1	Valve
8	154B3169	1	Bushing	33	158B3169	3	O-Ring
9	10892293P	1	O-Ring	34	166B3169	1	Backup Ring
10	161B3619	1	O-Ring	35	165B3169	1	O-Ring
11	14292293P	1	Nozzle	36	164B3169	1	Valve Guide
12	14192293P	1	Nipple	37	163B3169	1	Backup Ring
13	177B3169	1	O-Ring	38	162B3169	1	Piston
14	178B3169	1	Spring	39	159B3169	1	Ball
15	179B3169	1	Ball	40	157B3169	1	Spring
16	11492293P	1	O-Ring	41	156B3169	1	Stopper
17	197B3169	1	Hose Barb	42	95320	1	Garden Hose Connector
18	11292293P	1	O-Ring	43	95458	1	Quick Connect
19	199B3169	1	Inj. Housing				

Kit No.	50592293P O-Ring Kit	50692294P O-Ring Kit
Items in Kit	8, 9, 41, 40, 33, 39, 28, 29, 38, 37, 36, 35, 34, 32, 31, 30	24, 10, 13, 14, 15, 16, 17 & 18
Assemblies in Kit	NA	NA
# of Cylinders Kit will service	NA	NA

LIMITED PRESSURE WASHER WARRANTY

GENERAC PORTABLE PRODUCTS (hereafter referred to as the COMPANY) warrants to the original retail purchaser, the pressure washer manufactured by the COMPANY to be free from defects in material and workmanship for the period(s) set forth below from the date of original purchase. This warranty is not transferable. The term "original purchaser" means the person for whom the pressure washer is originally purchased.

Warranty Schedules

Electric Power Washer	1 year (does not apply to commercial or rental applications)		
		CONSUMER*	COMMERCIAL*
All Other Engine-driven	Engine:	Warranted solely by Engine Manufacturer	Warranted solely by Engine Manufacturer
	Pump:	1 year	90 days

*** NOTE: For the purpose of this warranty "consumer" use means personal residential household use by original purchaser. "Commercial" use means all other uses, including rental, construction, commercial and income producing purposes. Once a pressure washer has experienced commercial use, it shall thereafter be considered a commercial use pressure washer for the purposes of this warranty.**

During said warranty period, the COMPANY will, at its option, repair or replace any part which, upon examination by the COMPANY or COMPANY-Authorized Dealers, is found to be defective under normal use and service**. All transportation costs under warranty, including return to the factory if necessary, are to be borne by the purchaser and prepaid by the purchaser.

**** NORMAL WEAR: As with all mechanical devices, pressure washers need periodic parts service and replacement to perform well. This warranty does not cover repair when normal use has exhausted the life of a part or pressure washer pump.**

This warranty does not include: Used products and demonstration equipment. Parts, such as GUNS, HOSES, WANDS, NOZZLES or other wear items such as quick couplers, oil, gauges, belts, o-rings, filters, pump packing, etc. Pumps which have been run without water supplied. Damage or malfunctions resulting from: accidents, abuse, modifications, alterations, or improper servicing. Freezing or chemical deterioration. Normal maintenance such as adjustments, fuel system cleaning and obstruction (due to chemical, dirt, carbon or lime, etc.).

THIS WARRANTY IS IN PLACE OF ALL OTHER WARRANTIES, EXPRESS OR IMPLIED, SPECIFICALLY, THE COMPANY MAKES NO OTHER WARRANTIES AS TO MERCHANTABILITY OR FITNESS FOR A PARTICULAR PURPOSE. THE DURATION OF ANY IMPLIED WARRANTIES WHICH CANNOT BE DISCLAIMED IS LIMITED TO THE TIME PERIOD AS SPECIFIED IN THE EXPRESS WARRANTY. LIABILITY FOR CONSEQUENTIAL, INCIDENTAL, OR SPECIAL DAMAGES UNDER ANY AND ALL WARRANTIES IS EXCLUDED, EVEN IF SUCH DAMAGES ARE A DIRECT RESULT OF THE COMPANY'S NEGLIGENCE. THE COMPANY ALSO DISCLAIMS ANY RESPONSIBILITY FOR INCIDENTAL OR CONSEQUENTIAL DAMAGES SUCH AS THE LOSS OF TIME OR THE USE OF THE POWER EQUIPMENT, OR ANY COMMERCIAL LOSS DUE TO THE FAILURE OF THE EQUIPMENT: AND ANY IMPLIED WARRANTIES ARE LIMITED TO THE DURATION OF THIS WRITTEN WARRANTY.

Some states do not allow limitations on how long an implied warranty lasts, or the exclusion or limitation of incidental or consequential damages, so the above limitations or exclusions may not apply to you. This warranty gives you specific legal rights and you may also have other rights, which vary from state to state.

For service, see your nearest COMPANY-Authorized warranty service facility or call 1-877-544-0982. Warranty service can be performed only by a COMPANY-Authorized service facility. This warranty will not apply to service at any other facility. At the time of requesting warranty service, evidence of original purchase date must be presented.

Generac Portable Products

Jefferson, Wisconsin U.S. A.