

GENERAC®
Portable Products

3000PSI

High Pressure Washer Owner's Manual

**Problems?
Questions?**

Before taking your unit
back to the store,
call the pressure washer
helpline at

1-800-270-1408
M-F 8-5 CT

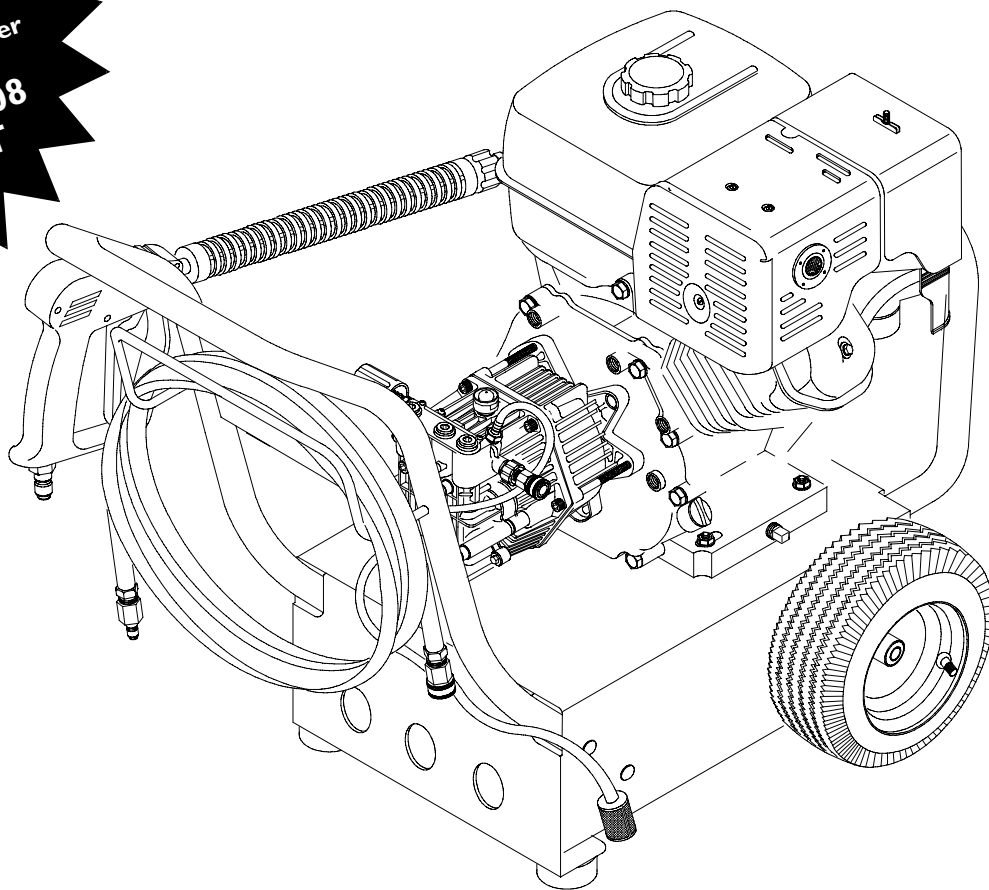

Model No. 1418-0 (3,000 PSI High Pressure Washer) Manual No. B5606 Revision 0 (11/14/2000)

Visit our Generac website: www.generac-portables.com



This is the safety alert symbol. It is used to alert you to potential personal injury hazards. Obey all safety messages that follow this symbol to avoid possible injury or death.



EQUIPMENT DESCRIPTION

CONGRATULATIONS on your purchase of a GENERAC high pressure washer. It has been designed, engineered and manufactured to give you the best possible dependability and performance.

This manual contains information for a high pressure washer that operates at 3,000 PSI at a flow rate of 3.0 gallons per minute. This powerful, high quality residential system features large 10" wheels, a pump equipped with an automatic cool down system, chemical injection system, adjustable unloader, nozzle extension with quick connect nozzles, safety goggles, heavy duty 50' hose, and more.

Please read and retain this manual. The instructions will enable you to assemble your unit and maintain your high pressure washer properly.

Every effort has been made to ensure that the information in this manual is both accurate and current. However, Generac reserves the right to change, alter or otherwise improve the product and its documentation at any time without prior notice.

Should you experience any problem you cannot easily fix, call the pressure washer helpline at **1-800-270-1408**.

CUSTOMER RESPONSIBILITIES

- Read and observe the safety rules.
- Follow regular schedule in maintaining, caring for and using your high pressure washer.
- For off-season storage, review "Storage" on page 13.

SAFETY RULES

CAUTION! When setting up, transporting, adjusting or making repairs to your high pressure washer, always disconnect the spark plug wire from the spark plug and place the wire where it cannot contact spark plug.

DANGER! Engine exhaust gases contain **DEADLY** carbon monoxide gas. This dangerous gas, if breathed in sufficient concentrations, can cause unconsciousness or even death. Operate this equipment only in the open air where adequate ventilation is available.

DANGER! Gasoline is highly **FLAMMABLE** and its vapors are **EXPLOSIVE**. **Do Not** permit smoking, open flames, sparks or heat in the vicinity while handling gasoline. Avoid spilling gasoline on a hot engine. Allow unit to cool for 2 minutes before refueling. Comply with all laws regulating storage and handling of gasoline.

Read this manual carefully and become familiar with your pressure washer. Know its applications, its limitations, and any hazards involved.

	WARNING:	
The engine exhaust from this product contains chemicals known to the State of California to cause cancer, birth defects, or other reproductive harm.		

- Locate this pressure washer in areas away from combustible materials, combustible fumes or dust.
- The high pressure equipment is designed to be used with Generac authorized parts **ONLY**. If you use this equipment with parts that do not comply with minimum specifications, the user assumes all risks and liabilities.
- Some chemicals or detergents may be harmful if inhaled or ingested, causing severe nausea, fainting or poisoning. The harmful elements may cause property damage or severe injury.
- **Do Not** allow **CHILDREN** to operate the pressure washer at any time.



- Operate engine only at governed speed. Running the engine at excessive speeds increases the hazard of personal injury. **Do Not** tamper with parts which may increase or decrease the governed speed.
- **Do Not** wear loose clothing, jewelry or anything that may be caught in the starter or other rotating parts.
- Before starting the pressure washer in cold weather, check all parts of the equipment and be sure ice has not formed there.
- **Never** use a spray gun which does not have a trigger lock or trigger guard in place and in working order.
- Keep the hose connected to machine or the spray gun while the system is pressurized. Disconnecting the hose while the unit is pressurized is dangerous.
- **Never** operate units with broken or missing parts, or without protective housing or covers.
- Check the fuel system for leaks or signs of deterioration, such as chafed or spongy hose, loose or missing clamps, or damaged tank or cap. Correct all defects before operating the pressure washer.
- **Do Not** spray flammable liquids.
- Use a respirator or mask whenever there is a chance that vapors may be inhaled. Read all instructions with mask so you are certain the mask will provide the necessary protection against inhaling harmful vapors.
- **Never** aim the gun at people, animals or plants. The high pressure stream of water that this equipment produces can pierce skin and its underlying tissues, leading to serious injury and possible amputation.
- **Never** allow any part of the body to come in contact with the fluid stream. **Do Not** come in contact with a fluid stream created by a leak in the high pressure hose.
- Always wear eye protection when you use this equipment or when you are in the vicinity where the equipment is in use.
- High pressure spray can cause paint chips or other particles to become airborne.
- **Do Not** operate the pressure washer above the rated pressure.
- **Never** move the machine by pulling on the high pressure hose. Use the handle provided on the unit.
- Always be certain the spray gun, nozzles and accessories are correctly attached.
- **Do Not** secure the spray gun in the (open) position.
- High pressure spray may damage fragile items including glass. **Do Not** point spray gun at glass when in the jet spray mode.
- Hold the spray gun firmly in your hand before you start the unit. Failure to do so could result in an injury from a whipping spray gun. **Do Not** leave the spray gun unattended while the machine is running.
- The cleaning area should have adequate slopes and drainage to reduce the possibility of a fall due to slippery surfaces.
- Keep water spray away from electric wiring or fatal electric shock may result.
- **Do Not** by-pass any safety device on this machine.
- The muffler and engine heat up during operation and remain hot immediately after shutting it down. Avoid contact with a hot muffler or engine as you could be severely burned.
- Operate and store this unit on a stable surface.
- High pressure hose can develop leaks from wear, kinking, abuse, etc. Water spraying from a leak is capable of injecting material into skin. Inspect hose each time before using it. Check all hoses for cuts, leaks, abrasions or bulging of cover, or damage or movement of couplings. If any of these conditions exist, replace hose immediately. **Never** repair high pressure hose. Replace it with another hose that meets maximum pressure rating of your unit.
- The muffler and air cleaner must be installed and in good condition before operating the pressure washer. These components act as spark arresters if the engine backfires.

In the State of California a spark arrestor is required by law (Section 4442 of the California Public Resources Code). Other states may have similar laws. Federal laws apply on federal lands.

NOTE: If you equip the muffler with a spark arrestor, it must be maintained in effective working order. You can order a replacement spark arrestor through your authorized Honda service dealer.



KNOW YOUR PRESSURE WASHER

Read this owner's manual and safety rules before operating your high pressure washer.

Compare the illustrations with your high pressure washer to familiarize yourself with the locations of various controls and adjustments. Save this manual for future reference.

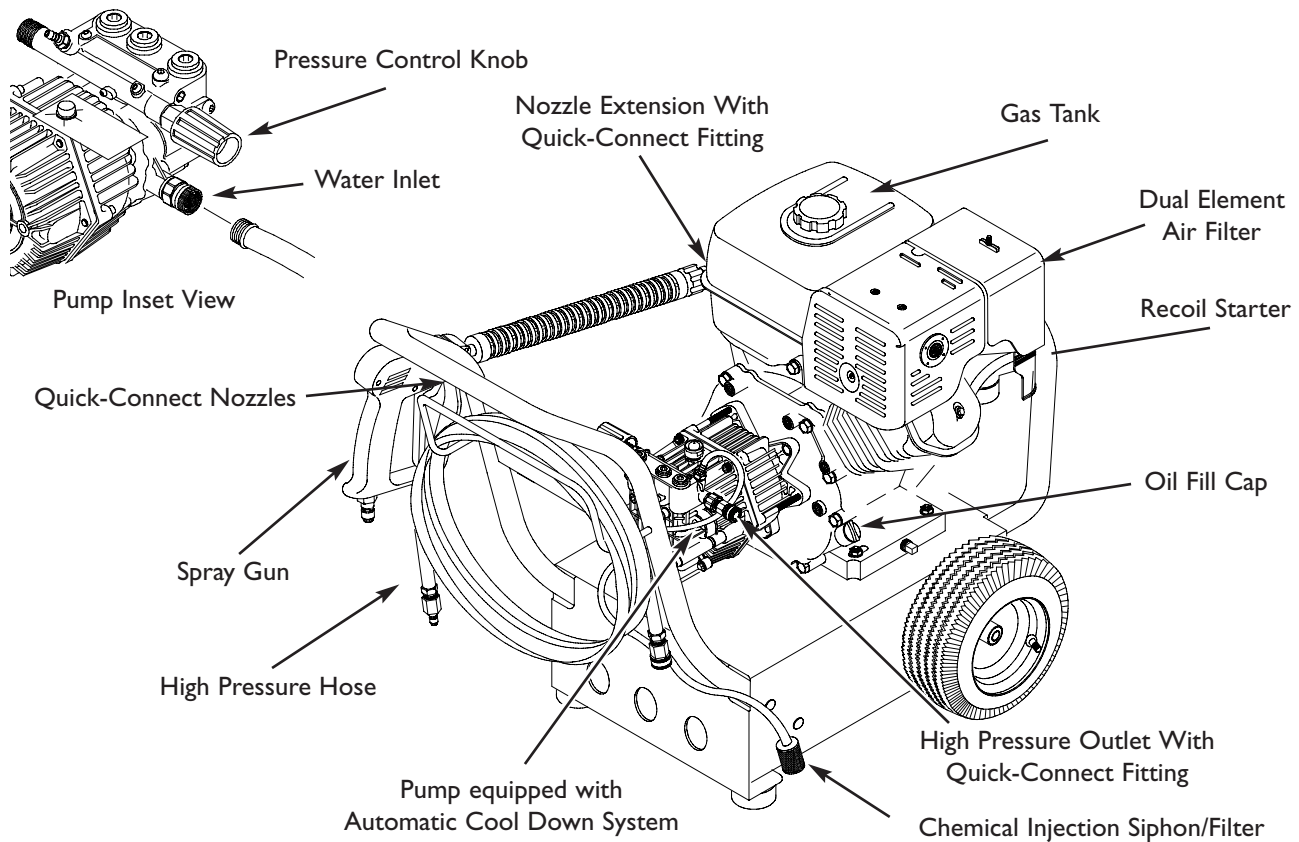

Automatic Cool Down System — Cycles water through pump when water reaches 140°-145°F. **Warm water will discharge from pump onto ground. This system prevents internal pump damage.**

Chemical Injection Siphon/Filter — Insert filter and hose into chemical container.

Dual Element Air Filter — Filter limits the amount of dirt and dust that gets in the engine.

Gas Tank — Fill tank with regular unleaded gasoline. Always leave room for fuel expansion.

High Pressure Hose — Connect one end to the water pump and the other end to the spray gun.

High Pressure Outlet With Quick-Connect Fitting — Connection for high pressure hose.

Nozzle Extension With Quick-Connect Fitting — You must attach this to the spray gun to use the nozzles. The quick-connect fitting lets you quickly exchange the four provided nozzles to adjust the spray pattern of the high pressure spray and apply chemical.

Oil Fill Cap — Fill engine with oil here.

Pressure Control Knob — Varies the pressure of the high pressure spray.

Pump — Develops high pressure.

Quick-Connect Nozzles - Chemical injection, 0°, 15°, 25°, 40°: for various cleaning applications.

Recoil Starter — Use for starting the engine manually.

Spray Gun — Controls the application of water onto cleaning surface with trigger device. Includes safety latch.

Water Inlet — Connect garden hose here.

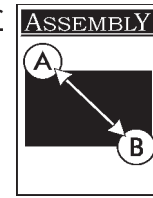

WARNING! Read entire owner's manual before you attempt to assemble or operate your new pressure washer.

REMOVE PRESSURE WASHER FROM CARTON

- Remove the high pressure hose and parts box included with pressure washer.
- Slice two corners at the end of carton from top to bottom so the panel can be folded down flat, then remove all packing material.
- Roll pressure washer out of carton.

CARTON CONTENTS

Items in the carton include:

- Main Unit
- High Pressure Hose
- Handle Assembly
- Parts Box, includes:
 - (2) 20oz oil bottles
 - Safety goggles
 - Nozzle cleaning kit
 - Bag Containing 5 multi-colored nozzles
 - O-Ring maintenance kit
 - Owner's manual
 - Engine manual
 - Engine warranty
 - Emissions control system warranty
 - Spray gun
 - Nozzle extension with quick-connect fitting.
 - Parts Bag (containing hardware to attach handle to pressure washer)
 - 4 Carriage Bolts
 - 4 Flange Nuts

If any of the above parts are missing or damaged, call the pressure washer helpline at **1-800-270-1408**.

PREPARING PRESSURE WASHER FOR USE

If you have any problems with the assembly of your pressure washer or if parts are missing or damaged, call the pressure washer helpline at **1-800-270-1408**.

To prepare your pressure washer for operation, you will need to perform these tasks:

- Fill out and send in the registration card for a valid warranty.
- Attach the handle to the main unit.
- Add oil to the engine.
- Add fuel to the fuel tank.
- Connect high pressure hose to spray gun and pump.
- Connect the water supply to the pump.
- Connect nozzle extension to gun.
- Select and install desired nozzle.

Attach Handle to the Pressure Washer

Use either a 13mm wrench or adjustable wrench to attach the handle to the pressure washer.

To attach handle to the pressure washer:

- Slowly tip the pressure washer forward and let it gently rest on the front bumper.
- Align the holes on the handle with the holes on the base.
- Insert the carriage bolts provided to hold the handle in place (Figure 1).

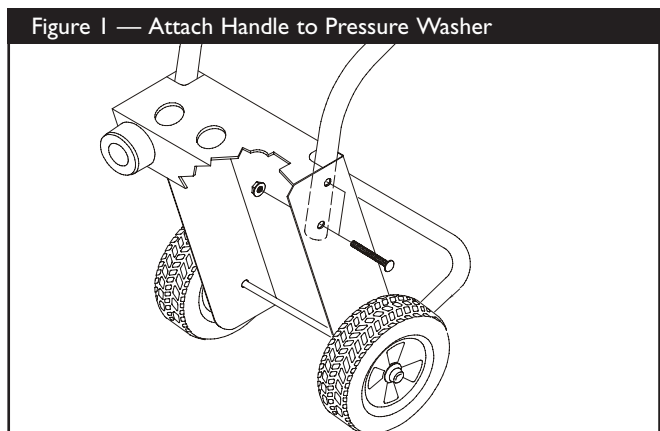
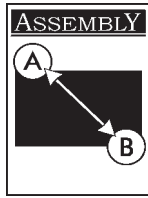

Figure 1 — Attach Handle to Pressure Washer



- Secure handle to the pressure washer using the four provided flange nuts.
- Slowly tip the pressure washer back in place and insert the multi-colored nozzles in the spaces provided in the handle.

Add Engine Oil

Place the unit on a flat, level surface. See engine owner's manual for proper oil and fill technique.

NOTE: The pump is pre-lubricated and sealed, requiring no additional lubrication for the life of the pump.

Add Gasoline

! DANGER! Never fill fuel tank indoors. Never fill fuel tank when engine is running or hot. Do Not smoke when filling fuel tank.

! WARNING! Never fill fuel tank completely full. Provide space for fuel expansion. Wipe away any fuel spillage from engine and equipment before starting.

- Use clean regular unleaded fuel and store in approved clean covered containers. Use clean fill funnels. Never use "stale" gasoline left over from last season or gasoline stored for long periods.
- Clean the area around the fuel fill cap, remove the cap. Slowly fill tank to the bottom of the filler neck (Figure 2).

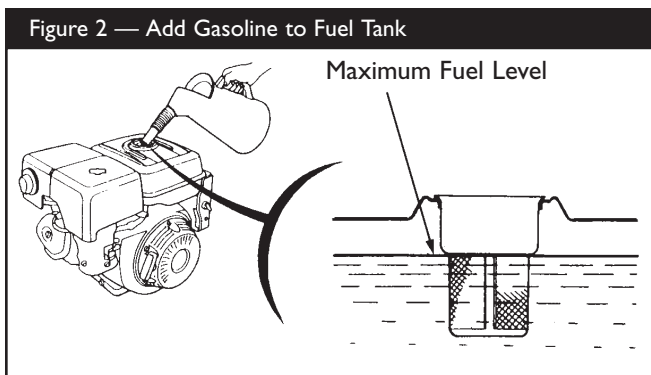

- Install the fuel cap and wipe up any spilled gasoline.

Connect Hose and Water Supply to Pump

IMPORTANT: You must assemble the nozzle extension to the spray gun and attach all hoses before you start the engine. Starting engine without all hoses connected and water supplied will damage the pump.

- Uncoil high pressure hose and attach quick connect end of hose to the base of the spray gun (Figure 3). Pull down on the collar of the quick connect, slide onto the gun and let go of collar. Tug on hose to be sure of a tight connection.

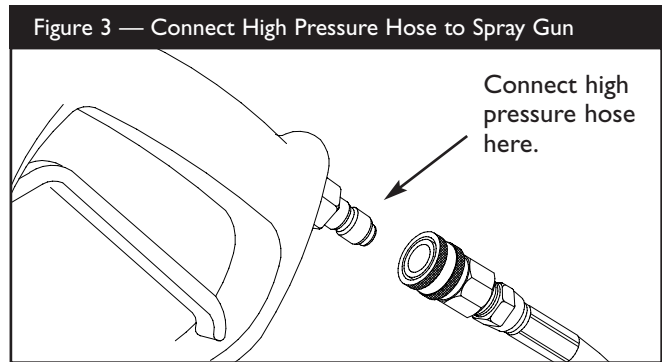

- Similarly, attach the other end of the high pressure hose to the high pressure outlet on the pump. Pull down on the collar of the quick connect, slide onto the pump and let go of collar. Pull on hose to be sure of a tight connection.
- Before you connect your garden hose to the water inlet, inspect the inlet screen (Figure 4). Clean the screen if it contains debris, replace it if it is damaged. **DO NOT RUN THE PRESSURE WASHER IF THE SCREEN IS DAMAGED.**

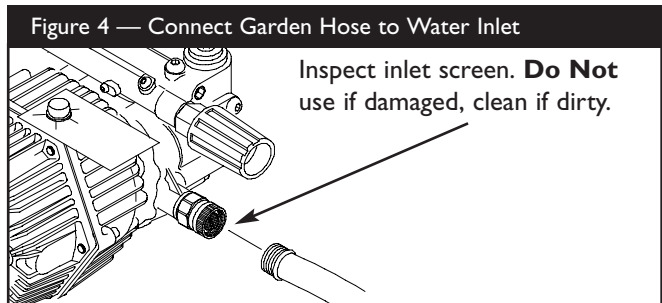

- Run water through your garden hose for 30 seconds to clean out any debris. Turn off water.

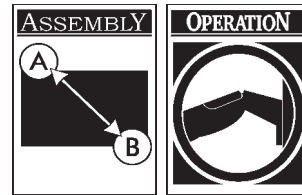

- Connect the garden hose to the water inlet. Tighten by hand (Figure 4).
- Turn ON the water.
- Squeeze the trigger on the gun until you have a steady stream of water. This purges the pump of air and impurities.

CAUTION! Before starting the pressure washer, be sure you are wearing adequate eye protection.

CHECKLIST BEFORE STARTING ENGINE

Review the unit's assembly to confirm you have performed all of the following:

- Make sure the handle and wireform are in place and secure.
- Check for properly tightened hose connections.
- Check to make sure that there are no kinks, cuts, or damage to the high pressure hose.
- Check that oil has been added to the proper level in the engine crankcase.
- Add the proper gasoline to fuel tank.
- Provide a proper water supply (not to exceed 140°F) at an adequate flow.
- Be sure to read the "Safety Rules" (page 2) and "Preparing Pressure Washer For Use" (page 5) before using the pressure washer.

HOW TO USE YOUR PRESSURE WASHER

If you have any problems operating your pressure washer, please call the pressure washer helpline at **1-800-270-1408**.

How to Start Your Engine

The best way to start your engine-powered pressure washer for the first time is to follow these instructions step-by-step. This starting information also applies whenever you start the engine after you have let the pressure washer sit idle for at least a day.

- Place the pressure washer in an area close enough to an outside water source that can flow at a rate of 3.3 gallons per minute or more.
- Make sure the unit is in a level position.
- Check that the high pressure hose is connected to the spray gun and to the pump. See "Preparing Pressure Washer for Use" on page 5.
- Connect the garden hose to the water inlet on the pressure washer pump and turn on the water.

WARNING! Do Not run the pump without the water supply connected and turned on. You must follow this caution or the pump will be damaged.

- Attach the nozzle extension to the spray gun. Tighten by hand (Figure 5).

Figure 5 — Connect Nozzle Extension to Spray Gun

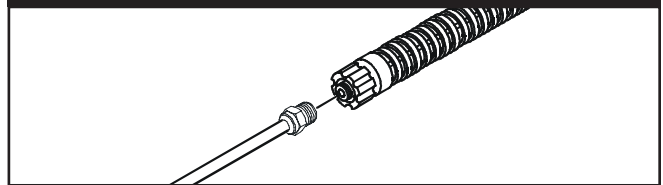

- Squeeze the trigger on the spray gun to relieve the air pressure caused by turning ON the water. Water will spew out of the gun in a thin stream. Hold the trigger until a steady stream of water appears. This will make it easier to pull start the engine. Release the trigger.
- Apply the safety latch to the spray gun trigger (Figure 6).

Figure 6 — Spray Gun with Safety Latch Engaged

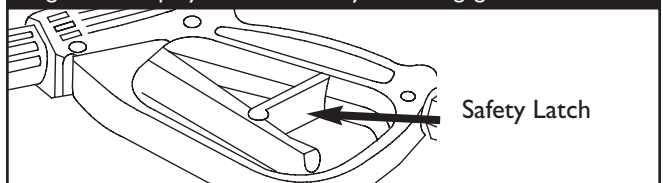

- Move the fuel valve to the "On" position (Figure 7).

Figure 7 — Fuel Valve

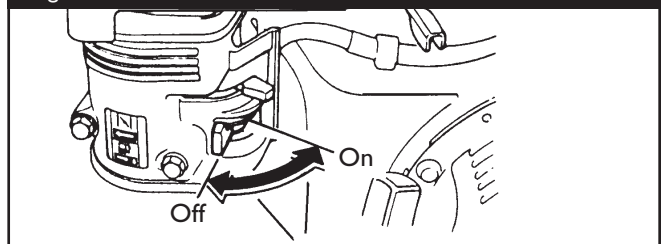



- Move the throttle lever to the “**Fast**” position (Figure 8).

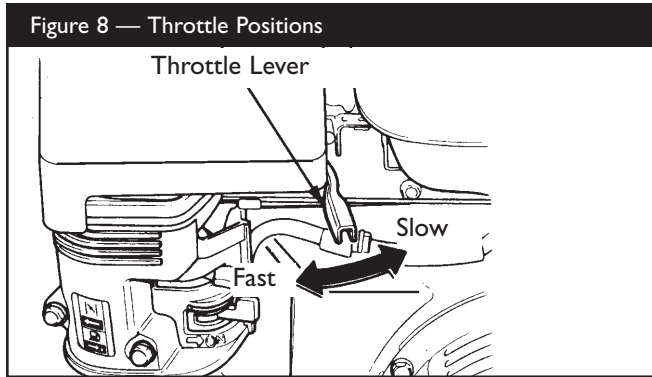

- **To start a cold engine**, move the choke lever to the “**Closed**” position. **To restart a warm engine**, leave the choke lever in the “**Open**” position (Figure 9).

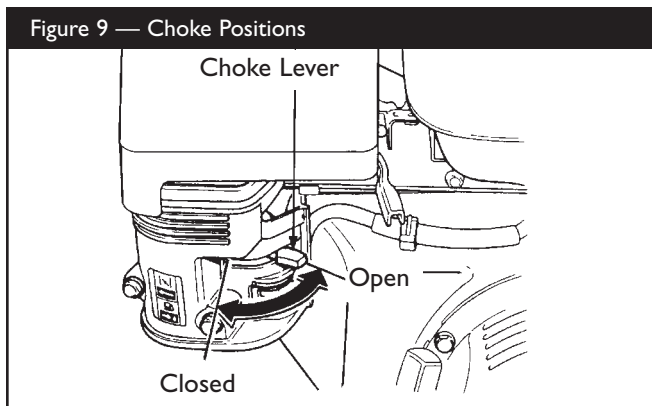

- Set the engine switch to the “**On**” position (Figure 10).

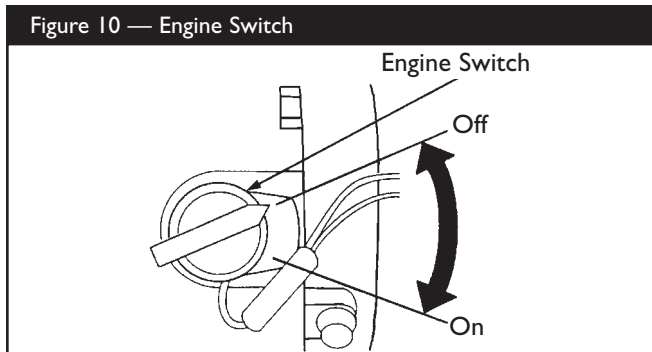

- Grasp starter grip and pull slowly until you feel some resistance. Then pull cord out with rapid full arm stroke. Let rope return slowly. **Do Not** let rope “snap back” against starter.
- If the choke lever has been moved to the “**Closed**” position to start the engine, gradually move it to the “**Open**” position as the engine warms up.
- Select and insert a quick-connect nozzle into the nozzle extension.

How to Stop Your Pressure Washer

- Move the throttle lever to the “**Slow**” position.
- Wait for the engine to idle down.
- Move the engine switch to the “**Off**” position.
- Simply shutting off the engine will not release pressure in the system. **Squeeze trigger on the spray gun to relieve pressure in the hose.**

How to Use the Nozzles

If you have any problems operating your pressure washer, please call the pressure washer helpline at **1-800-270-1408**.

! DANGER! Never exchange nozzles without locking the safety latch on the trigger.

The quick-connect on the nozzle extension allows you to switch between five different nozzles. The nozzles vary the spray pattern as shown on the next page (Figure 11).

Follow these instructions to change nozzles:

- Engage the safety latch on the spray gun.
- Pull back the collar on the quick-connect and pull the current nozzle off. Store the nozzle in the space provided on the handles storage panel.

NOTE: For a more gentle rinse, select the white 40° or green 25° nozzle. To scour the surface, select the yellow 15° or red 0° nozzle. To apply chemical, select the black nozzle.



Figure 11 — Nozzles

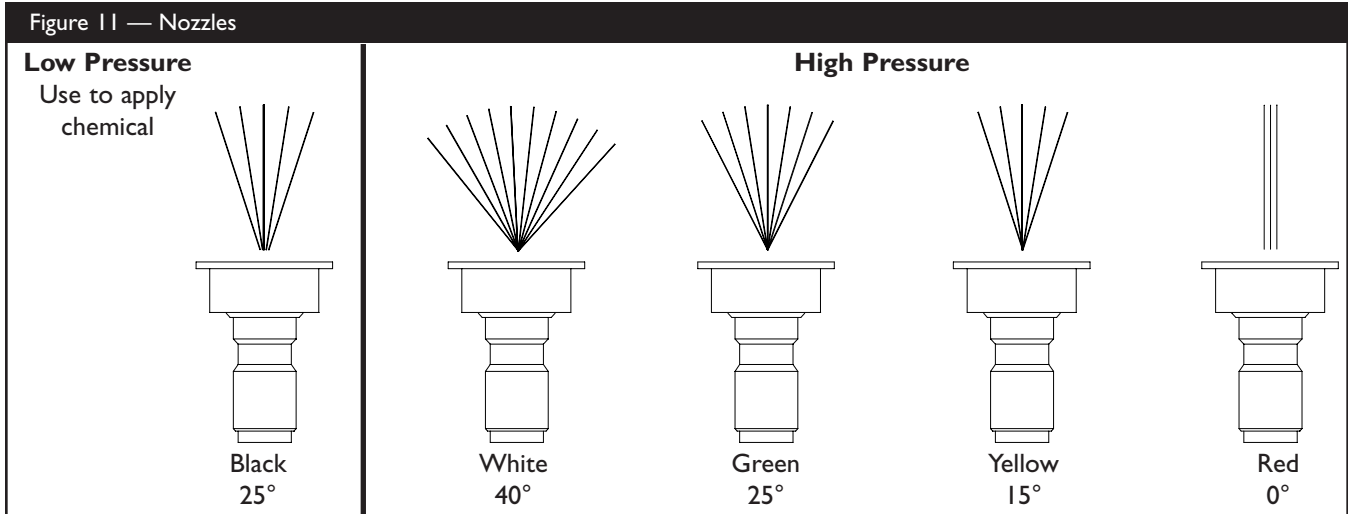

- Pull back on the collar, insert the new nozzle and release the collar. Tug on the nozzle to make sure it is securely in place.
- For most effective cleaning, keep the spray nozzle between 8 to 24 inches away from the cleaning surface. If you get the spray nozzle too close, you may damage the cleaning surface.

Cleaning and Applying Chemical

WARNING! You must **attach all hoses** before you start the engine. Starting the engine without all the hoses connected and without the water turned ON will damage the pump.

IMPORTANT: Use soaps designed specifically for pressure washers. Household detergents could damage the pump.

To apply detergent follow these steps:

- Review the use of the nozzles.

- Prepare the detergent solution as required by the manufacturer.
- Place the chemical injection siphon/filter into the detergent container.

CAUTION! Keep the chemical injection tube from coming in contact with the hot muffler.

- Make sure the black nozzle is installed.

NOTE: Detergent cannot be applied with the high pressure nozzles (White, Green, Yellow, or Red).

- Make sure the garden hose is connected to the water inlet. Check that the high pressure hose is connected to the spray gun and the pump and start the engine.
- Apply the detergent to a dry surface, starting at lower portion of area to be washed and work upward, using long, even, overlapping strokes. **Do Not** allow the detergent to dry on (prevents streaking).
- Allow the detergent to soak in between 3–5 minutes before washing and rinsing. Reapply as needed to prevent surface from drying.



Pressure Washer Rinsing

WARNING! Be extremely careful if you must use the pressure washer from a ladder, scaffolding or any other relatively unstable location. Hose water pressure builds as you climb. When you press the trigger, the recoil from the initial spray can be very strong. The high pressure spray could force you to fall if you are too close to the cleaning surface.

After you have applied detergent, scour the surface and rinse it clean as follows:

- Apply safety latch to spray gun.
- Remove the black chemical nozzle from the nozzle extension.
- Select and install the desired high pressure nozzle following the instructions “How to Use the Nozzles” on page 8.
- Release the safety latch on the spray gun.
- Keep the spray gun a safe distance from the area you plan to spray.
- Increase or decrease spray pressure by turning the pressure control knob counterclockwise or clockwise respectively (Figure 12). Use lower pressure to wash items such as a car or boat. Use higher pressure to strip paint and degrease driveways.

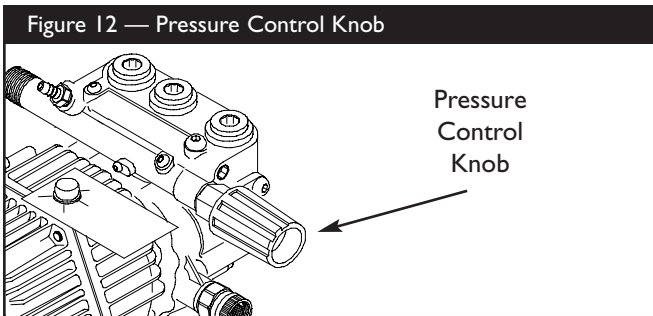

- Apply a high pressure spray to a small area and then check the surface for damage. If no damage is found, you can assume it is okay to continue cleaning.
- Start at the top of the area to be rinsed, working down with same overlapping strokes as you used for cleaning.

Automatic Cool Down System (Thermal Relief)

If you run the engine on your pressure washer for 3-5 minutes without pressing the trigger on the spray gun, circulating water in the pump can reach a temperature between 140–145°F. When the water reaches this temperature, the automatic cool down system engages and cools the pump by **discharging the warm water onto the ground**. This system prevents internal damage to the pump.

SPECIFICATIONS

Rated Pressure 3,000 PSI

Flow Rate 3.0 gallons per minute (gpm)

Detergent Use detergent approved for pressure washers

Water Supply

Temperature Not to Exceed 140°F

Automatic Cool Down System Will cycle when water reaches 140°-145°F

Pump Oil SAE 80W90, 9.6 oz (285 mL)

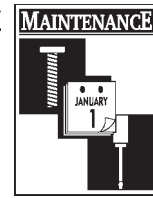

GENERAL MAINTENANCE RECOMMENDATIONS

The pressure washer warranty does not cover items that have been subjected to operator abuse or negligence. To receive full value from the warranty, the operator must maintain the high pressure washer as instructed in this manual.

- Some adjustments will need to be made periodically to properly maintain your high pressure washer.
- All maintenance in this manual and the engine owner's manual should be made at least once each season.
- Once a year you should clean or replace the spark plug, clean or replace the air filter and check the gun and nozzle extension assembly for wear. A new spark plug and clean air filter assure proper fuel-air mixture and help your engine run better and last longer. Please refer to your engine owner's manual for more details.

BEFORE EACH USE

- Check engine oil level.
- Check water inlet screen for damage.
- Check in-line filter for damage.
- Check high pressure hose for leaks.
- Check detergent siphoning tube and filter for damage.
- Check gun, nozzle extension, and nozzles for leaks.
- Rinse out garden hose to flush out debris.

PRESSURE WASHER MAINTENANCE

Check and Clean Inlet Screen

Examine the screen on the water inlet. Clean it if the screen is clogged or replace it if screen is damaged.

Check High Pressure Hose

The high pressure hose can develop leaks from wear, kinking, or abuse. Inspect the hose each time before using it. Check for cuts, leaks, abrasions or bulging of cover, damage or movement of couplings. If any of these conditions exist, replace the hose immediately.



WARNING! Water spraying from a leak is capable of injecting material into skin. Inspect hose each time before using it. **Never** repair a high pressure hose. Replace it with another hose that meets the maximum pressure rating of your pressure washer.

Check Detergent Siphoning Tube

Examine the filter on the detergent tube and clean if clogged. The tube should fit tightly on the barbed fitting. Examine the tube for leaks or tears. Replace the filter or tube if either is damaged.

Cleaning Detergent Siphoning Tube

If you used the detergent siphoning tube, you must flush it with clean water before stopping the engine.

- Place the chemical injection siphon/filter in a bucket full of clean water.
- Attach the black low pressure nozzle.
- Flush for 1-2 minutes.
- Shut off the engine.

IMPORTANT: Simply shutting **OFF** engine will not release pressure in the system. **When the engine has shut down, squeeze the trigger on the gun to relieve the pressure in the hose.**

Check Gun and Nozzle Extension

Examine the hose connection to the gun and make sure it is secure. Test the trigger by pressing it and making sure it springs back into place when you release it. Put the safety latch in the on position and test the trigger. You should not be able to press the trigger.

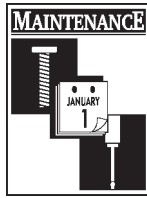

Check In-Line Filter

Refer to Figure 13 and service the in-line filter if it becomes clogged, as follows:

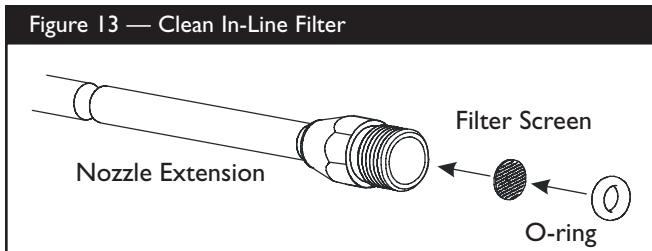

1. Detach gun and nozzle extension from high pressure hose. Detach nozzle extension from gun and remove o-ring and screen from nozzle extension. Flush the screen, gun, and adjustable nozzle extension with clean water to clear debris.
2. If the screen is damaged, the o-ring kit contains a replacement in-line filter screen and an o-ring. If undamaged, reuse screen.
3. Place the in-line filter screen into the threaded end of the nozzle extension. Direction does not matter. Push the screen in with the eraser end of a pencil until it rests flat at the bottom of the opening. Take care to not bend the screen.
4. Place the o-ring into the recess. Push the o-ring snugly against the in-line filter screen.
5. Assemble the nozzle extension to the spray gun, as described earlier in this manual.

Purge Pump of Air and Contaminants

To remove air from the pump, follow these steps:

- Set up the pressure washer as described in “Preparing Pressure Washer For Use” (page 5). Connect the water supply and turn water on.
- Remove the nozzle from the nozzle extension.
- Pull the trigger on the gun and hold.
- When the water supply is steady and constant, engage the safety latch and refasten the nozzle attachment.

To remove contaminants from the pump, follow these steps:

- Set up the pressure washer as described in “Preparing Pressure Washer For Use” (page 5). Connect the water supply and turn water on.
- Remove the nozzle from the nozzle extension.
- Start the engine according to instructions in “How To Use Your Pressure Washer” (page 7).
- Squeeze the trigger on the gun and hold.
- When the water supply is steady and constant, engage the safety latch and refasten the nozzle attachment.

Nozzle Maintenance

If a nozzle becomes restricted or clogged with foreign materials, such as dirt, excessive pump pressure may develop. A pulsing sensation occurs during use. This generally is not a pump related problem, but rather a clogged or partially restricted nozzle.

If a nozzle become clogged or partially restricted, immediately clean it with the kit included with your pressure washer by following these instructions:

- Shut off the engine and turn off the water supply.
- Remove the nozzle from the end of the nozzle extension.
- Use the wire included in the kit or a small paper clip to free the foreign materials clogging or restricting the nozzle (Figure 14).

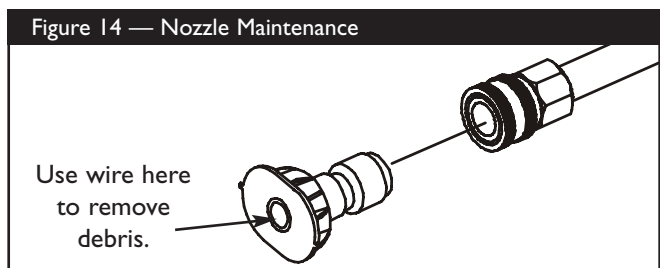

- Remove additional debris by rinsing out the nozzle. Rinse between 30 to 60 seconds.
- Reinstall the nozzle into the nozzle extension.
- Reconnect the water supply, turn on the water, and start the engine.
- Test the pressure washer.

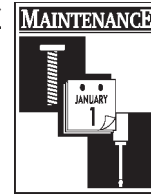

O-Ring Maintenance

Through the normal operation of your pressure washer, o-rings, which keep the connections of the hoses and gun tight and leak-free, may become worn or damaged.

Provided with your pressure washer is an O-Ring Maintenance Kit which includes replacement o-rings, rubber washer and water inlet filter.

To remove a worn or damaged o-ring:

- Use a small flathead screwdriver to get underneath the o-ring and pry it off.

ENGINE MAINTENANCE

See the engine owner's manual for instructions on how to properly maintain the engine.

PREPARING THE UNIT FOR STORAGE

Water should not remain in the unit for long periods of time. Sediments or minerals can deposit on pump parts and "freeze" pump action. If you do not plan to use the pressure washer for more than 30 days, follow this procedure:

1. Flush detergent siphoning tube by placing the filter into a pail of clean water while running pressure washer in low pressure mode (adjustable nozzle in the forward position). Flush for one to two minutes.
2. Shut off the engine and let it cool, then remove all hoses. Disconnect spark plug wire from spark plug.
3. Empty the pump of all pumped liquids by pulling the recoil handle about 6 times. This should remove most of the liquid in the pump.

NOTE: To protect the unit from freezing temperatures, draw RV antifreeze (non-alcohol) into the pump by pouring the solution into a 3-foot section of garden hose connected to inlet adapter and pulling recoil handle twice.

4. Store unit in a clean, dry area.

STORING THE ENGINE

See the engine owner's manual for instructions on how to properly prepare the engine for storage.



TROUBLESHOOTING

Problem	Cause	Correction
Pump has following problems: failure to produce pressure, erratic pressure, chattering, loss of pressure, low water volume.	<ol style="list-style-type: none"> 1. Low pressure nozzle installed. 2. Water inlet is blocked. 3. Inadequate water supply. 4. Inlet hose is kinked or leaking. 5. Clogged inlet hose strainer. 6. Water supply is over 140°F. 7. High pressure hose is blocked or leaks. 8. Gun leaks. 9. Nozzle is obstructed. 10. Pump is faulty. 	<ol style="list-style-type: none"> 1. Replace nozzle with high pressure nozzle. 2. Clear inlet. 3. Provide adequate water flow. 4. Straighten inlet hose, patch leak. 5. Check and clean inlet hose strainer. 6. Provide cooler water supply. 7. Clear blocks in outlet hose. 8. Replace gun. 9. Clean nozzle. 10. Contact Generac service facility.
Detergent fails to mix with spray.	<ol style="list-style-type: none"> 1. Detergent siphoning tube is not submerged. 2. Chemical filter is clogged. 3. Dirty in-line filter. 4. Low pressure nozzle installed. 	<ol style="list-style-type: none"> 1. Insert detergent siphoning tube into detergent. 2. Clean or replace filter/detergent siphoning tube. 3. See "Check In-Line Filter" on page 12. 4. Replace nozzle with high pressure nozzle.
Engine runs good at no-load but "bogs" when load is added.	Engine speed is too slow.	Move throttle control to FAST position. If engine still "bogs down", contact Honda service facility.
Engine will not start; or starts and runs rough.	<ol style="list-style-type: none"> 1. Low oil level. 2. Dirty air cleaner. 3. Out of gasoline. 4. Stale gasoline. 5. Spark plug wire not connected to spark plug. 6. Bad spark plug. 7. Water in gasoline. 8. Overchoking. 9. Excessively rich fuel mixture. 10. Intake valve stuck open or closed. 11. Engine has lost compression. 	<ol style="list-style-type: none"> 1. Fill crankcase to proper level. 2. Clean or replace air cleaner. 3. Fill fuel tank. 4. Drain gas tank; fill with fresh fuel. 5. Connect wire to spark plug. 6. Replace spark plug. 7. Drain gas tank; fill with fresh fuel. 8. Open choke fully and crank engine. 9. Contact Honda service facility. 10. Contact Honda service facility. 11. Contact Honda service facility.
Engine shuts down during operation.	<ol style="list-style-type: none"> 1. Out of gasoline. 2. Low oil level. 	<ol style="list-style-type: none"> 1. Fill fuel tank. 2. Fill crankcase to proper level.
Engine lacks power.	Dirty air filter.	Replace air filter.
Engine "hunts" or falters.	Choke is opened too soon.	Move choke to halfway position until engine runs smoothly.

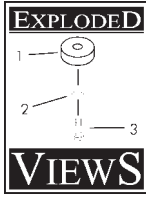

EXPLODED VIEW — UNIT

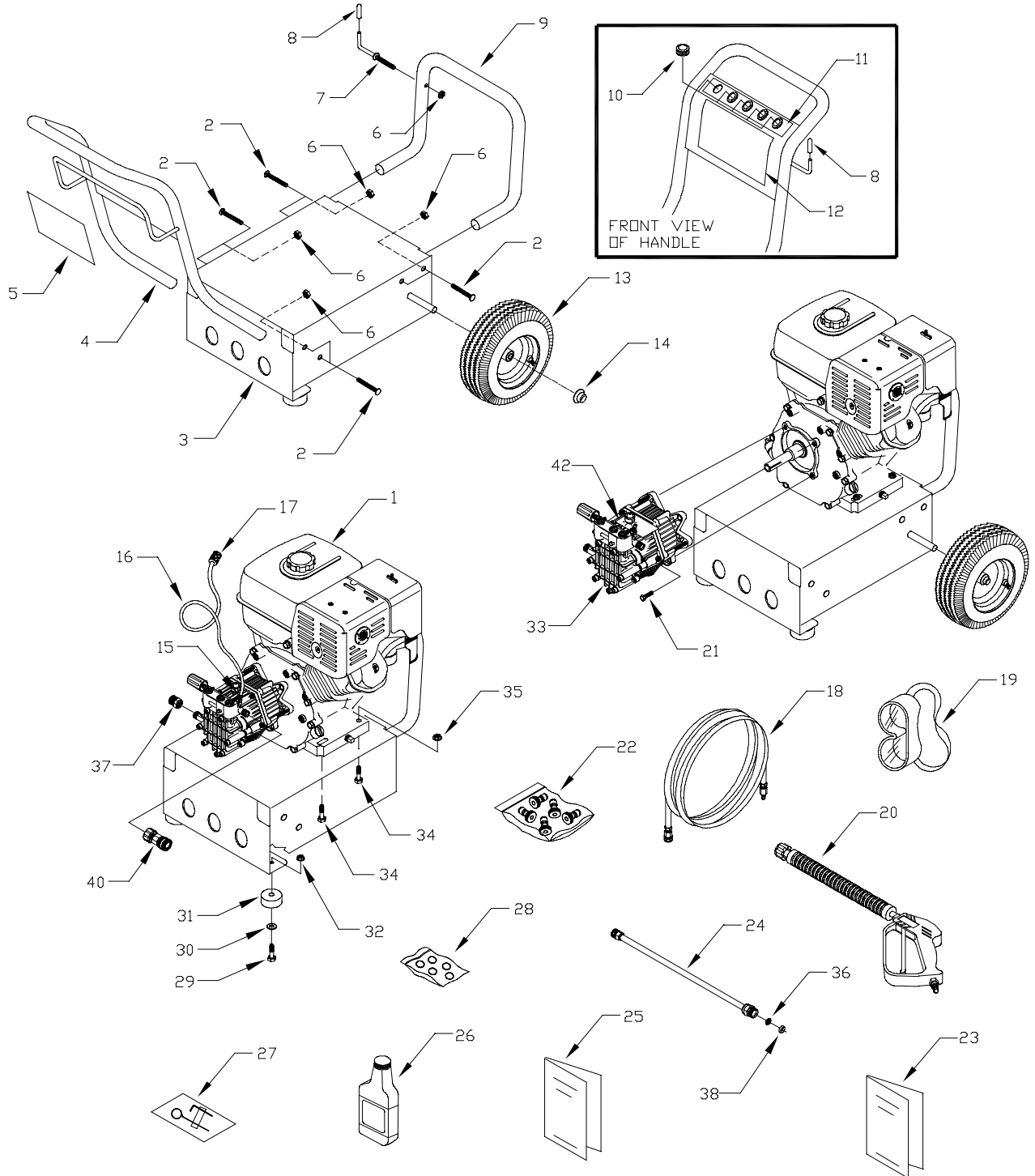

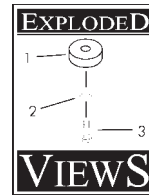

PARTS LIST — UNIT

Item	Part #	Qty.	Description
1	NSP	1	ENGINE
2	B2043	8	BOLT, 5/16" - 18 x 1-3/4" Carriage
3	BB2226B	1	BASE
4	CB3861C	1	HANDLE
5	B4160	1	DECAL, Instructions
6	99583	9	NUT, 5/16" - 18 Hex Flange
7	B2150	1	HOOK, 5/16" Square Neck Gun
8	B2516	2	CAP, Black Vinyl .280"
9	CB4105	1	BUMPER
10	30809	5	GROMMET, 1/8" - 11/16"
11	B4159	1	DECAL, 5 QD Nozzles
12	B5607	1	DECAL, Unit
13	88521	2	ASSEMBLY, Wheel 10" Dia. x 4"
14	75402	2	PUSHNUT, .50"
15	48031G	1	CLAMP, Hose 7/16" Dia.
16	A1040D	1	HOSE, 54" Chemical Inject
17	A1041	1	FILTER, Chemical Hose
18	B4805	1	HOSE, 3/8" x 50'
19	87815	1	GOGGLES, Safety
20	B1436B	1	GUN, with Molded Grip
21	23707	4	SHCS, 5/16" - 24 x 1"
22	186301	1	KIT, Nozzles QD
23	B5606	1	MANUAL, Owners
24	B3858	1	ASSY., Wand Ext. with QD
25	B1464	1	MANUAL, Engine
26	BB3061B	2	OIL BOTTLE
27	B2509	1	KIT, Nozzle Cleaning
28	B5830	1	KIT, O-Ring Maintenance
29	42909	2	HHCS, M8 - 1.25 x 30
30	50190	2	FLAT WASHER, 10GA - .34" x 1"
31	27007	2	VIB MOUNT, Donut Type
32	52858	2	NUT, Locking M8 - 1.25
33	NSP	1	ASSEMBLY, Pump (see pages 18-19)
34	64416	4	BOLT, M10 - 1.5 x 45 mm
35	52859	4	NUT, Locking M10 - 1.50
36	B4224	1	SCREEN, Gun Inlet
37	21424	1	CONNECTOR, Garden Hose
38	97837	1	O-RING, High Pressure Hose
40	185923	1	QUICK CONNECT, M22 Female
42	B1288	1	TAG, Breather Cap

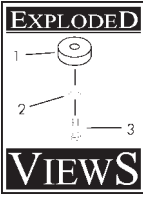

EXPLODED VIEW — PUMP

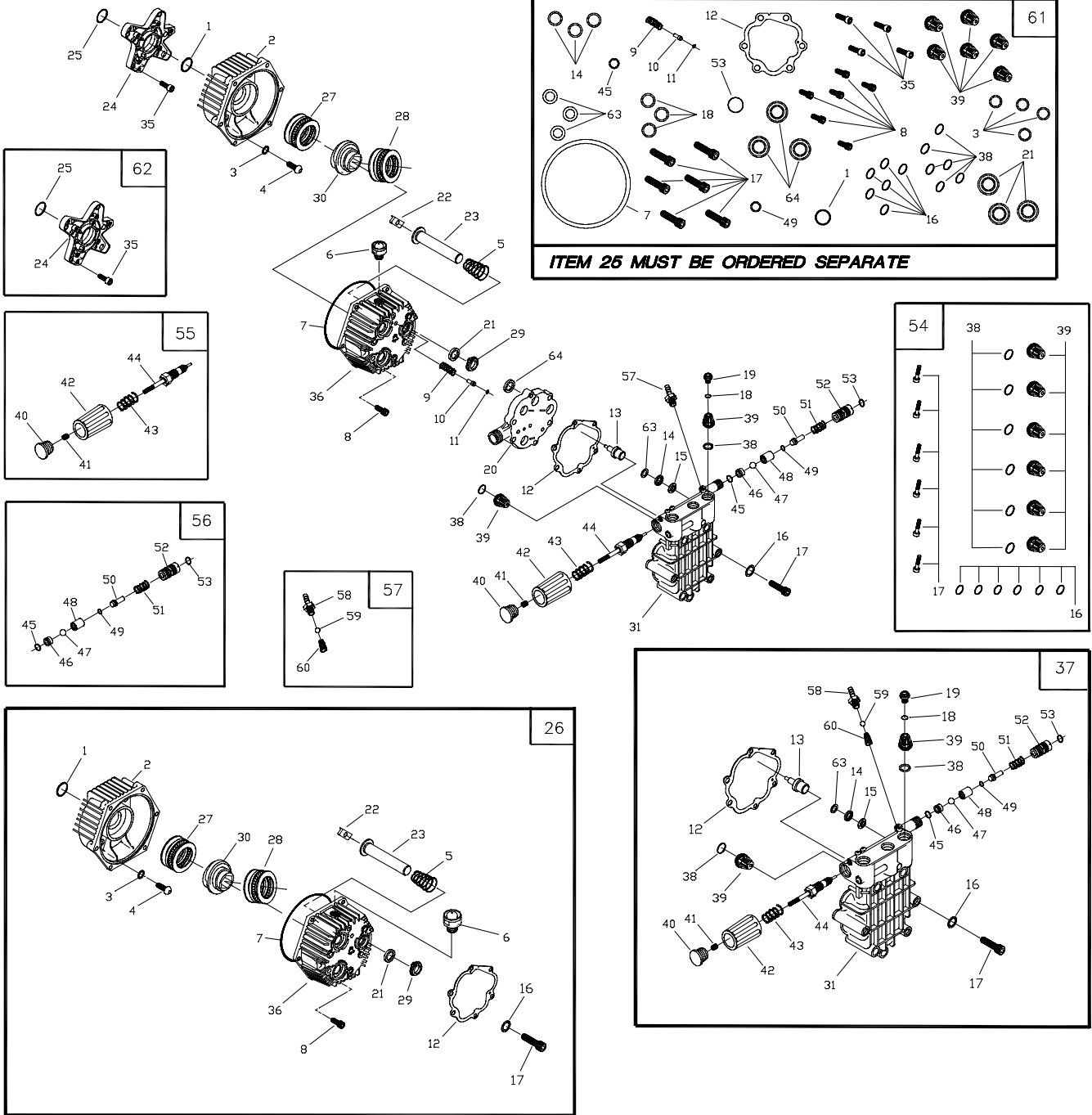

ITEM 25 MUST BE ORDERED SEPARATE

26

37

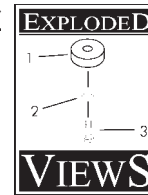

PARTS LIST — PUMP

Item	Part #	Qty	Description	Item	Part #	Qty	Description
1	B2218	1	O-RING, Engine Adapter	47	1	BALL, Stainless Steel 9/32 Dia.
2	B2260	1	HOUSING, Cam	48	1	SEAT, Trapped Line Pressure
3	B2217	4	O-RING, Engine Adapter Bolt	49	1	O-RING, Trapped Line Pressure
4	B2261B	4	SCREW, Button Hd 5/16 - 24 x 3/4"	50	1	VALVE, Shuttle Piston
5	96400	3	SPRING, Piston Return	51	1	SPRING, Piston Trapped Pressure
6	99735	1	ASSEMBLY, Oil Breather	52	1	VENTURI, Chemical
7	93790	1	O-RING, Crankcase	53	1	O-RING, Venturi
8	40945	6	SHCS, M6 x 1.0 x 20mm	58	1	BARB HOSE
9	93652	1	SPRING, Thermal By-Pass	59	1	BALL, 5.5 dia. Chemical Injector
10	95416	1	PISTON, Thermal By-Pass	60	1	SPRING, Chemical Injector
11	93876	1	O-RING, Thermal By-Pass	63	1	SPACER, High Pressure Seal
12	A2069	1	GASKET, Head	54	185933	0	KIT, Check Valve
13	93644	1	ACTUATOR, Thermal By-Pass	16	6	WASHER, Steel Special
14	96053	3	SEAL, High Pressure	17	6	BOLT, Head M8 x 1.25 x 70mm
15	96015	3	RING, Bearing	38	6	O-RING, Check Valve
16	B2665	6	WASHER, Steel Special	39	6	ASSEMBLY, Check Valve
17	A2013	6	BOLT, Head M8 x 1.25 x 70mm	55	B3479	0	KIT, Unloader Spindle
18	97840	3	O-RING, Cap	40	1	CAP, Plastic
19	97841	3	CAP, Outlet Port	41	1	SET SCREW, M6 x 8
20	A1320	1	SPACER PLATE	42	1	HANDLE, Unloader
21	B3286	3	SEAL, Oil Piston	43	1	SPRING, Unloader
22	94944	3	SHOE, Piston Pivot	44	1	ASSEMBLY, Spindle
23	99427	3	ASSEMBLY, Ceramic Piston & Cap	56	B3510	0	KIT, High Pressure Outlet
24	B3672C	1	ADAPTER, Engine, Honda 8 - 9 HP	45	1	O-RING, Ball Seat
25	185726	1	O-RING, Engine Adapter	46	1	SEAT, Ball Unloader
26	186216A	0	KIT, Crankcase, 7.5	47	1	BALL, Stainless Steel 9/32 Dia.
1	1	O-RING, Engine Adapter	48	1	SEAT, Trapped Line Pressure
2	1	ADAPTER, Housing, Cam	49	1	O-RING, Trapped Line Pressure
3	4	O-RING, Engine Adapter Bolt	50	1	VALVE, Shuttle Piston
4	4	SCREW, Button Hd 5/16 - 24 x 3/4"	51	1	SPRING, Piston Trapped Pressure
5	3	SPRING, Piston Return	52	1	VENTURI, Chemical
6	1	ASSEMBLY, Oil Breather	53	1	O-RING, Venturi
7	1	O-RING, Crankcase	57	185943	0	KIT, Chemical Injector
8	6	SHCS, M6 x 1.0 x 20mm	58	1	BARB HOSE
12	1	GASKET, Head	59	1	BALL, 5.5 dia. Chemical Injector
16	6	WASHER, Steel Special	60	1	SPRING, Chemical Injector
17	6	BOLT, Head M8 x 1.25 x 70mm	61	185926	0	KIT, O-Ring Seals
21	3	SEAL, Oil Piston	1	1	O-RING, Engine Adapter
22	3	SHOE, Piston Pivot	3	4	O-RING, Engine Adapter Bolt
23	3	ASSEMBLY, Ceramic Piston & Cap	7	1	O-RING, Crankcase
27	1	BEARING SET, 4 x 4	8	6	SHCS, M6 x 1.0 x 20mm
28	1	BEARING SET, 5.5 x 4	9	1	SPRING, Thermal By-Pass
29	3	SPACER, Pilot	10	1	PISTON, Thermal By-Pass
30	1	AXIAL CAM, 7.5 Lift	11	1	O-RING, Thermal By-Pass
36	1	HOUSING, Piston	12	1	GASKET, Head
37	185752	0	KIT, Complete Head	14	3	SEAL, High Pressure
12	1	GASKET, Head	16	6	WASHER, Steel Special
13	1	ACTUATOR, Thermal By-Pass	17	6	BOLT, Head M8 x 1.25 x 70mm
14	3	SEAL, High Pressure	18	3	O-RING, Cap
15	3	RING, Bearing	21	3	SEAL, Oil Piston
16	6	WASHER, Steel Special	35	4	BOLT, SHCS 5/16 - 24 x 1"
17	6	BOLT, Head M8 x 1.25 x 70mm	38	6	O-RING, Check Valve
18	3	O-RING, Cap	39	6	ASSEMBLY, Check Valve
19	3	CAP, Outlet Port	45	1	O-RING, Spindle
31	1	HEAD, Flat, Brass	49	1	O-RING, Trapped Line Pressure
38	6	O-RING, Check Valve	53	1	O-RING, Venturi
39	6	ASSEMBLY, Check Valve	63	1	SPACER, High Pressure Seal
40	1	CAP, Plastic	64	3	SEAL, Piston U-Cup
41	1	SET SCREW, M6 x 8	62	187791	0	KIT, ENGINE ADAPTER
42	1	HANDLE, Unloader	24	1	ADAPTER, Engine, Honda, 8 - 9 HP
43	1	SPRING, Unloader	25	1	O-RING, Engine Adapter
44	1	ASSEMBLY, Spindle	35	4	BOLT, SHCS 5/16 - 24 x 1"
45	1	O-RING, Ball Seat				
46	1	SEAT, Ball Unloader				

Item numbers 26, 37, 54, 55, 56, 57, 61 and 62 are service kits and include all parts shown within the box. Certain items are only available as a part of a kit.

LIMITED PRESSURE WASHER WARRANTIES

GENERAC PORTABLE PRODUCTS (hereafter referred to as the COMPANY) warrants to the original retail purchaser, the pressure washer manufactured by the COMPANY to be free from defects in material and workmanship for the period(s) set forth below from the date of original purchase. This warranty is not transferable. The term "original purchaser" means the person for whom the pressure washer is originally purchased.

Warranty Schedules

Electric Power Washer	1 year (does not apply to commercial or rental applications)		
		CONSUMER*	COMMERCIAL*
All Other Engine-driven	Engine:	Warranted solely by Engine Manufacturer	Warranted solely by Engine Manufacturer
	Pump:	1 year	90 days

*** NOTE: For the purpose of this warranty "consumer" use means personal residential household use by original purchaser. "Commercial" use means all other uses, including rental, construction, commercial and income producing purposes. Once a pressure washer has experienced commercial use, it shall thereafter be considered a commercial use pressure washer for the purposes of this warranty.**

During said warranty period, the COMPANY will, at its option, repair or replace any part which, upon examination by the COMPANY or COMPANY-Authorized Dealers, is found to be defective under normal use and service**. All transportation costs under warranty, including return to the factory if necessary, are to be borne by the purchaser and prepaid by the purchaser.

**** NORMAL WEAR: As with all mechanical devices, pressure washers need periodic parts service and replacement to perform well. This warranty does not cover repair when normal use has exhausted the life of a part or pressure washer pump.**

This warranty does not include: Used products and demonstration equipment. Parts, such as GUNS, HOSES, WANDS, NOZZLES or other wear items such as quick couplers, oil, gauges, belts, o-rings, filters, pump packing, etc. Pumps which have been run without water supplied. Damage or malfunctions resulting from: accidents, abuse, modifications, alterations, or improper servicing. Freezing or chemical deterioration. Normal maintenance such as adjustments, fuel system cleaning and obstruction (due to chemical, dirt, carbon or lime, etc.).

THIS WARRANTY IS IN PLACE OF ALL OTHER WARRANTIES, EXPRESS OR IMPLIED, SPECIFICALLY, THE COMPANY MAKES NO OTHER WARRANTIES AS TO MERCHANTABILITY OR FITNESS FOR A PARTICULAR PURPOSE. THE DURATION OF ANY IMPLIED WARRANTIES WHICH CANNOT BE DISCLAIMED IS LIMITED TO THE TIME PERIOD AS SPECIFIED IN THE EXPRESS WARRANTY. LIABILITY FOR CONSEQUENTIAL, INCIDENTAL, OR SPECIAL DAMAGES UNDER ANY AND ALL WARRANTIES IS EXCLUDED, EVEN IF SUCH DAMAGES ARE A DIRECT RESULT OF THE COMPANY'S NEGLIGENCE. THE COMPANY ALSO DISCLAIMS ANY RESPONSIBILITY FOR INCIDENTAL OR CONSEQUENTIAL DAMAGES SUCH AS THE LOSS OF TIME OR THE USE OF THE POWER EQUIPMENT, OR ANY COMMERCIAL LOSS DUE TO THE FAILURE OF THE EQUIPMENT: AND ANY IMPLIED WARRANTIES ARE LIMITED TO THE DURATION OF THIS WRITTEN WARRANTY.

Some states do not allow limitations on how long an implied warranty lasts, or the exclusion or limitation of incidental or consequential damages, so the above limitations or exclusions may not apply to you. This warranty gives you specific legal rights and you may also have other rights, which vary from state to state.

For service, see your nearest COMPANY-Authorized warranty service facility or call 1-877-544-0982. Warranty service can be performed only by a COMPANY-Authorized service facility. This warranty will not apply to service at any other facility. At the time of requesting warranty service, evidence of original purchase date must be presented.

Generac Portable Products

Jefferson, Wisconsin U.S. A.