

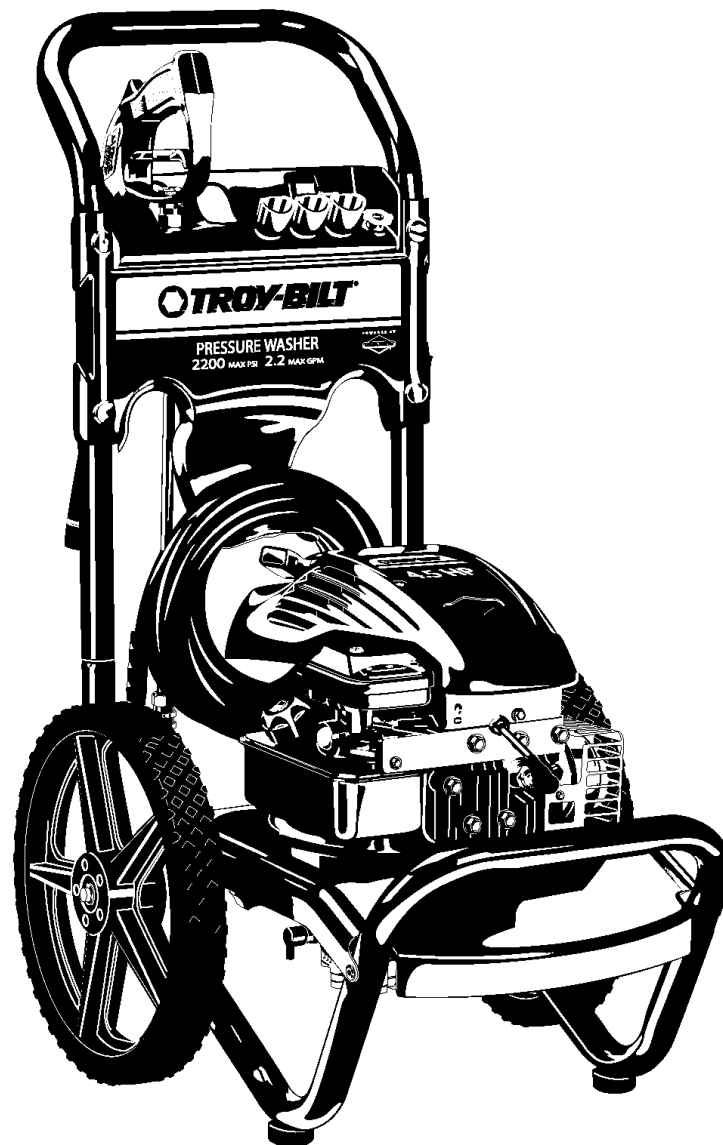

# Parts Manual

Mfg. No: 020245-1  
2,200 PSI Troy-Bilt





---

Model Components	Page
Main Unit.....	4
Pump.....	6
Torque Specification Chart.....	8

Not For  
Reproduction

# Main Unit

Note: Unless noted otherwise, use the standard torque specifications

Mfg. No: 020245-1

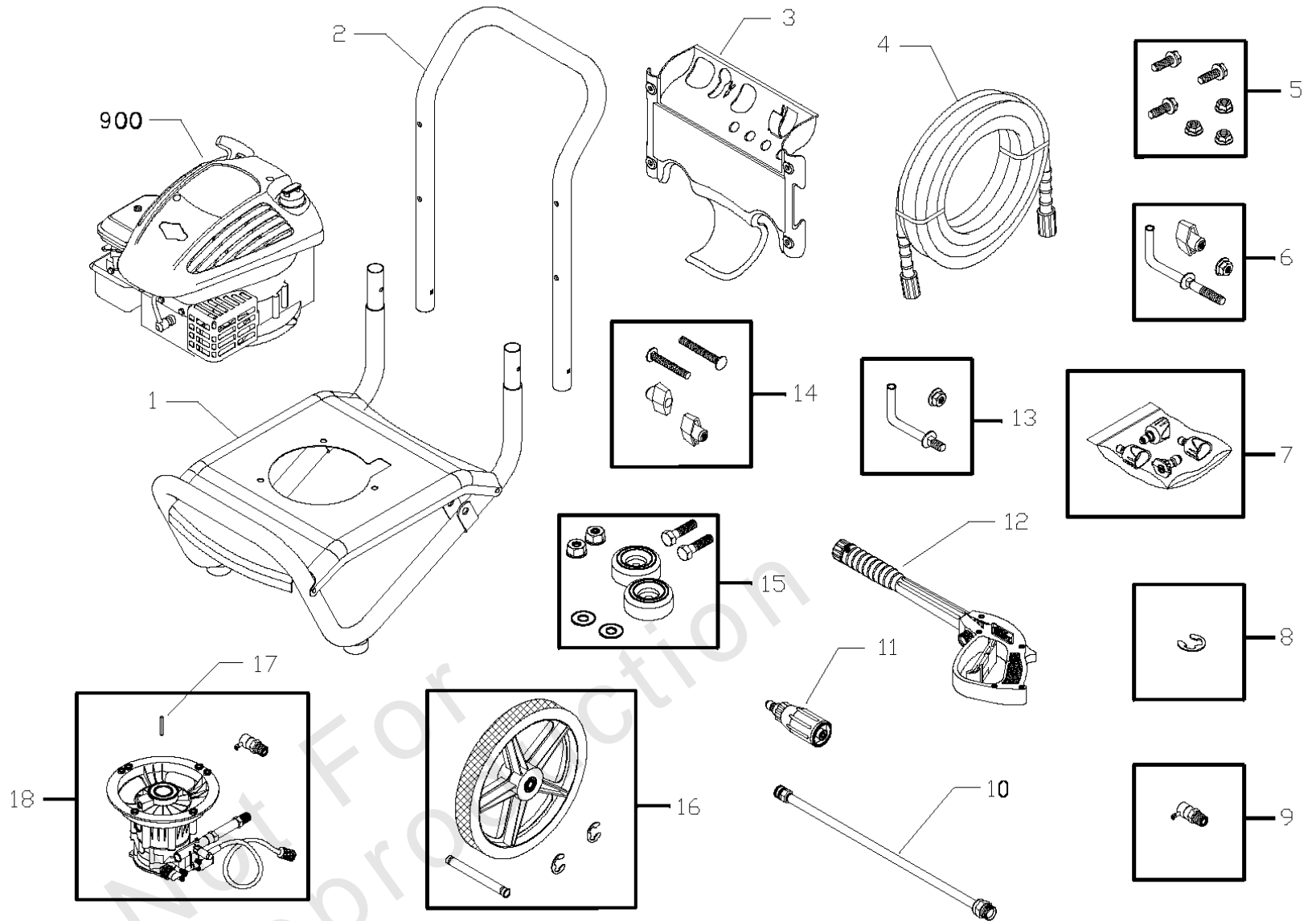

## Main Unit

REF NO	PART NO	QTY	DESCRIPTION
1	196471GS		ASSY, Base
2	P195428GS		HANDLE
3	197122GS		KIT, Billboard with Clips
	195964GS		CLIP,Tree
4	196006GS		HOSE'
5	192525GS		KIT, Pump Mounting Hardware
6	194264GS		KIT, Hook, Handle
7	195943GS		KIT, Nozzles
	195851ZZGS		NOZZLE, QC, Black
	195842AEGS		NOZZLE, Project Pro, Red
	195842XGS		NOZZLE, Project Pro, Orange
	195842RGS		NOZZLE, Project Pro, Yellow
8	192050GS		KIT, E-Ring 1/2"
9	194298GS		VALVE, Thermal Relief
10	190779GS		ASSY, Wand
11	195854GS		TURBO
12	193482GS		GUN
13	192309GS		KIT, Hook, Base
14	B2203GS		KIT, Handle Connector
15	192310GS		KIT, Vibration Mount
16	196439GS		KIT, Wheel
17	23139GS		KEY
18	197300GS		ASSY, Pump -(see "Pump")
900	-----		ENG1NE -Contact Engine Manufacturer
	197183GS		MANUAL, Operator's -Not Illustrated
	MS5573		MANUAL, Engine -Not Illustrated
	194256GS		KIT, Tag/Waring Srv -Not Illustrated
	195454GS		AXLE -Not Illustrated
	BB3061BGS		OIL BOTTLE -Not Illustrated
	87815GS		GOGGLES -Not Illustrated
	275034		LABEL, WARNING -Not Illustrated
	196219GS		DECAL, Engine Shroud -Not Illustrated
	100031		STABILIZER, Fuel -Optional Accessories Not Illustrated
	100516GS		KIT, O-Ring -Optional Accessories Not Illustrated
	6039		PUMP SAVER -Optional Accessories Not Illustrated

# Pump

Note: Unless noted otherwise, use the standard torque specifications

Mfg. No: 020245-1

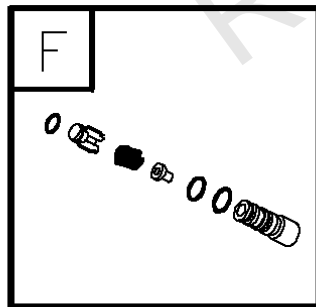
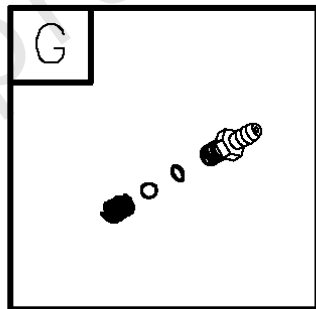
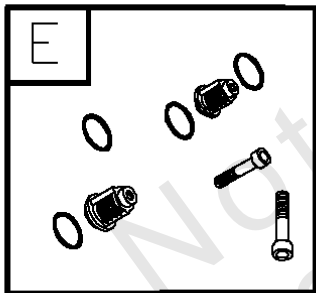
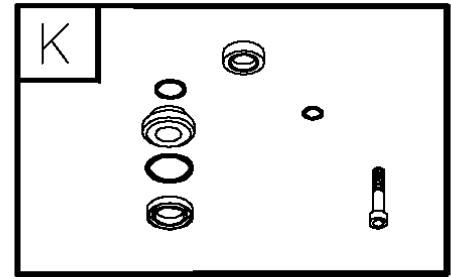
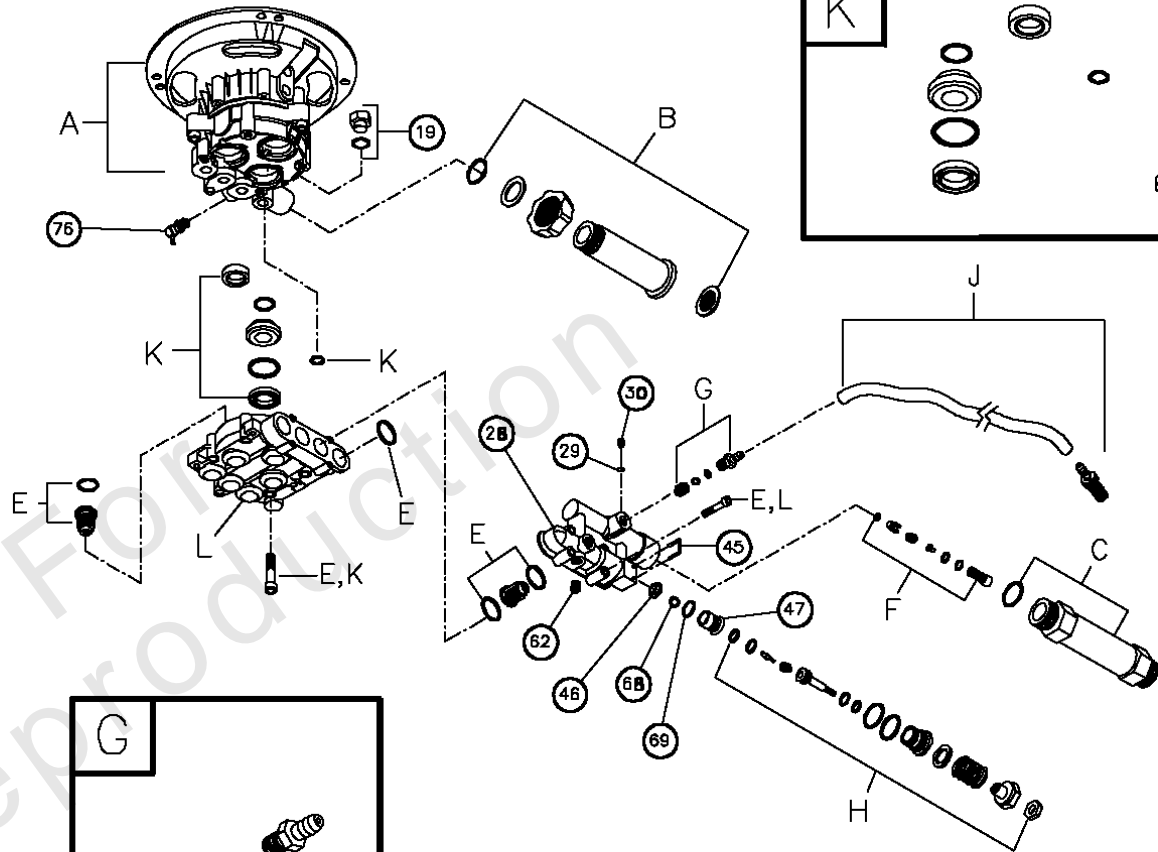
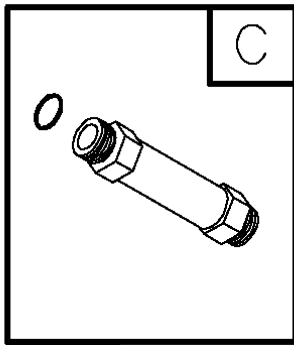
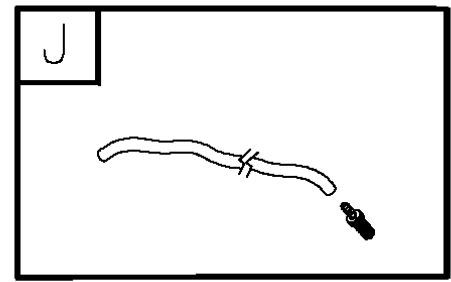
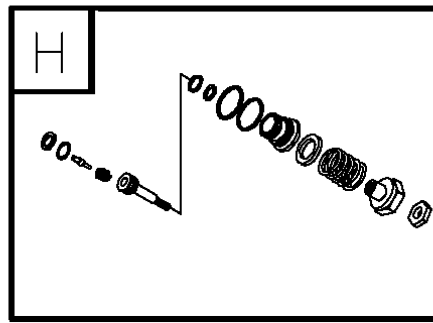
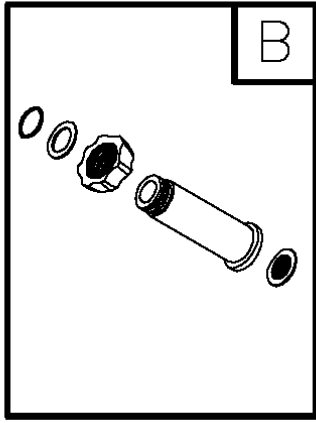

## Pump

REF NO	PART NO	QTY	DESCRIPTION
19	190571GS		CAP, Oil
28	190627GS		MANIFOLD
29	190575GS		O-RING, 4 X 2
30	198105GS		SCREW
45	190578GS		PIN
46	190629GS		VALVE, Seat Plate, Plastic
47	190630GS		VALVE, Seat, Plastic
62	190581GS		CAP, 1/8
68	190582GS		BALL, 7mm SS
69	190584GS		O-RING, 9.25 x 1.78
76	194298GS		THERMAL RELIEF
A	~NSP		ASSY, CASE, PISTON
B	190632GS		KIT,WATER INLET,ALUM -Service kit includes all parts shown within the box.
C	190634GS		KIT, OUTLET,ALUM -Service kit includes all parts shown within the box.
D	198106GS		KIT, HEAD -Service kit includes all parts shown within the box.
E	193806GS		KIT, CHECK VALVES -Service kit includes all parts shown within the box.
F	190592GS		KIT, INLET CHECK -Service kit includes all parts shown within the box.
G	190593GS		KIT, CHEMICAL INJECTION -Service kit includes all parts shown within the box.
H	190628GS		KIT, UNLOADER STEM -Service kit includes all parts shown within the box.
J	189971GS		KIT, CHEMICAL HOSE -Service kit includes all parts shown within the box.
K	197309GS		KIT, SEAL SET -Service kit includes all parts shown within the box.
	190586GS		OIL BOTTLE -Not Illustrated
	B2384GS		FILTER, Inlet -Not Illustrated
	186452GS		FILTER, Inlet, Bag of 10 -Not Illustrated

# Hardware Identification & Torque Specifications

Torque Specification Chart								
FOR STANDARD METRIC MACHINE HARDWARE (Tolerance ± 20%)								
Property Class	5.6		8.8		10.9		12.9	
	Class 5.6		Class 8.8		Class 10.9		Class 12.9	
Size Of Hardware	in/lbs	Nm.	in/lbs	Nm.	in/lbs	Nm.	in/lbs	Nm.
	ft/lbs		ft/lbs		ft/lbs		ft/lbs	
M3	5.88	.56	13.44	1.28	19.2	1.80	22.92	2.15
M4	13.44	1.28	30.72	2.90	43.44	4.10	52.56	4.95
M5	26.4	2.50	60.96	5.75	5.97	8.10	7.15	9.7
M6	44.64	4.3	7.3	9.9	10.3	14	12.1	16.5
M7	5.2	7.1	12.1	16.5	16.9	23	19.9	27
M8	7.7	10.5	17.7	24	25	34	29	40
M10	15	21	35	48	50	67	59	81
M12	26	36	61	83	86.2	117	103	140
M14	42	58	101	132	136	185	162	220
M16	64	88	147	200	210	285	250	340
M18	89	121	202	275	287	390	346	470
M20	126	171	290	390	405	550	486	660
M22	169	230	390	530	559	745	656	890
M24	217	295	497	375	708	960	840	1140
M27	320	435	733	995	1032	1400	1239	1680
M30	435	590	995	1350	1401	1900	1681	2280
M33	590	800	1349	1830	1902	2580	2278	3090
M36	759	1030	1740	2360	2441	3310	2935	3980
M39	988	1340	2249	3050	3163	4290	3798	5150

Torque Specification Chart						
FOR STANDARD MACHINE HARDWARE (Tolerance ± 20%)						
Hardware Grade	No Marks		SAE Grade 5		SAE Grade 8	
	SAE Grade 2		SAE Grade 5		SAE Grade 8	
Size Of Hardware	in/lbs	Nm.	in/lbs	Nm.	in/lbs	Nm.
	ft/lbs		ft/lbs		ft/lbs	
8-32	19	2.1	30	3.4	41	4.6
8-36	20	2.3	31	3.5	43	4.9
10-24	27	3.1	43	4.9	60	6.8
10-32	31	3.5	49	5.5	68	7.7
1/4-20	66	7.6	8	10.9	12	16.3
1/4-28	76	8.6	10	13.6	14	19.0
5/16-18	11	15.0	17	23.1	25	34.0
5/16-24	12	16.3	19	25.8	29	34.0
3/8-16	20	27.2	30	40.8	45	61.2
3/8-24	23	31.3	35	47.6	50	68.0
7/16-14	30	40.8	50	68.0	70	95.2
7/16-20	35	47.6	55	74.8	80	108.8
1/2-13	50	68.0	75	102.0	110	149.6
1/2-20	55	74.8	90	122.4	120	163.2
9/16-12	65	88.4	110	149.6	150	204.0
9/16-18	75	102.0	120	163.2	170	231.2
5/8-11	90	122.4	150	204.0	220	299.2
5/8-18	100	136	180	244.8	240	326.4
3/4-10	160	217.6	260	353.6	386	525.0
3/4-16	180	244.8	300	408.0	420	571.2
7/8-9	140	190.4	400	544.0	600	816.0
7/8-14	155	210.8	440	598.4	660	897.6
1-8	220	299.2	580	788.8	900	1,244.0
1-12	240	326.4	640	870.4	1,000	1,360.0

The guides and ruler furnished below are designed to help you select the appropriate hardware.



Nut, M8

Thread Diameter (mm)

Inside Diameter (in)      Threads per inch

Nut, 1/2-16

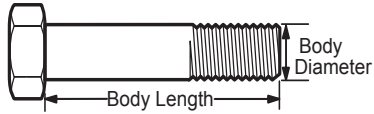

Screw, M8- 1.25 x 25

Thread Diameter (mm)      Distance between threads (mm)      Body Length (mm)

Body Diameter      Threads per inch      Body Length (in)

Screw, 1/2- 16 x 2



## Standard Hardware Sizing

When a washer or nut is identified as 1/2" (M8), this is the *Nominal size*, meaning the *inside diameter* is 1/2 inch (8mm metric thread diameter); if a second number is present it represents the *threads per inch* (distance between threads).

When bolt or capscrew is identified as 1/2 - 16 x 2" (M8 - 1.25 x 50), this means the *Nominal size*, or body diameter is 1/2 inch (8mm metric thread diameter), the second number, 16, represents the *threads per inch*, (*distance between threads*). The final number is the body length of the bolt or screw, 2 inches (50mm).

## NOTES

- These torque values are to be used for all hardware excluding: locknuts, self-tapping screws, thread forming screws, sheet metal screws and socket head setscrews.
- Recommended seating torque values for locknuts:
  - for prevailing torque locknuts - use 65% of grade 5 torques.
  - for flange whizlock nuts and screws - use 135% of grade 5 torques.
- Unless otherwise noted on assembly drawings, all torque values must meet this specification.

## Common Hardware Types

Hex Head Capscrew



Washer



Carriage Bolt



Hex Nut

## Wrench & Fastener Size Guide

1/4" Bolt or Nut Wrench—7/16"	5/16" Bolt or Nut Wrench—1/2"	3/8" Bolt or Nut Wrench—9/16"	7/16" Bolt or Nut Wrench (Bolt)—5/8" Wrench (Nut)—11/16"	1/2" Bolt or Nut Wrench—3/4"
M6 Bolt or Nut Wrench—10mm	M8 Bolt or Nut Wrench—13mm	M10 Bolt or Nut Wrench—17mm	M12 Bolt or Nut Wrench—19mm	M14 Bolt or Nut Wrench—22mm



