

**GENERAC<sup>®</sup>**  
Portable Products

# 2100PSI

## *Pressure Washer Owner's Manual*



Questions? Help is just a moment away!

Call: **Generac Pressure Washer Helpline - 1-800-270-1408** M-F 8-5 CT

Web: [www.generac-portables.com](http://www.generac-portables.com)

Model No. 1439-0 (2100 PSI Pressure Washer) Manual No. B5700 Revision 3 (06/19/2002)



## TABLE OF CONTENTS

Safety Rules.....	2-3
Know Your Pressure Washer.....	4
Assembly.....	5-7
Operation.....	8-10
Product Specifications.....	11
Maintenance.....	11-13
Storage.....	13
Notes.....	14
Troubleshooting.....	15
Replacement Parts.....	16-19
Warranty.....	Last Page

## EQUIPMENT DESCRIPTION

Read this manual carefully and become familiar with your pressure washer. Know its applications, its limitations and any hazards involved.

Every effort has been made to ensure that information in this manual is accurate and current. However, Generac reserves the right to change, alter or otherwise improve the product and this document at any time without prior notice.

### WARNING

The engine exhaust from this product contains chemicals known to the State of California to cause cancer, birth defects, or other reproductive harm.

In the State of California a spark arrester is required by law (Section 4442 of the California Public Resources Code). Other states may have similar laws. Federal laws apply on federal lands. If you equip the muffler with a spark arrester, it must be maintained in effective working order.

## SAFETY RULES

The safety alert symbol () is used with a signal word (DANGER, CAUTION, WARNING), a pictorial and/or a safety message to alert you to hazards. **DANGER** indicates a hazard which, if not avoided, will result in death or serious injury. **WARNING** indicates a hazard which, if not avoided, could result in death or serious injury. **CAUTION** indicates a hazard which, if not avoided, might result in minor or moderate injury. **CAUTION**, when used **without** the alert symbol, indicates a situation that could result in equipment damage. Follow safety messages to avoid or reduce the risk of injury or death.

### WARNING



Gasoline and its vapors are extremely flammable and explosive.

Fire or explosion can cause severe burns or death.

#### WHEN ADDING FUEL

- Turn pressure washer OFF and let it cool at least 2 minutes before removing gas cap.
- Fill fuel tank outdoors.
- Do not overfill tank. Allow space for fuel expansion.
- Keep gasoline away from sparks, open flames, pilot lights, heat, and other ignition sources.
- Do not light a cigarette or smoke.

#### WHEN OPERATING EQUIPMENT

- Do not tip engine or equipment at angle which causes gasoline to spill.
- Do not spray flammable liquids.

#### WHEN TRANSPORTING OR REPAIRING EQUIPMENT

- Transport/repair with fuel tank EMPTY or with fuel shutoff valve OFF.

#### WHEN STORING GASOLINE OR EQUIPMENT WITH FUEL IN TANK

- Store away from furnaces, stoves, water heaters, clothes dryers or other appliances that have pilot light or other ignition source because they can ignite gasoline vapors.

### WARNING



Spray contact with electrical wiring can result in electrocution.

- Keep water spray away from electric wiring or fatal electric shock may result.

### WARNING





The high pressure stream of water that this equipment produces can pierce skin and its underlying tissues, leading to serious injury and possible amputation.

- Never aim the spray gun at people, animals or plants.
- Do not allow CHILDREN to operate the pressure washer.
- Never repair high pressure hose. Replace it.



**! WARNING**

 The high pressure spray could also cause you to fall if you are too close to the cleaning surface. Pressure in a running washer builds as you climb. When you press the trigger, the recoil from the initial spray could cause you to fall.

 Use of pressure washer can create puddles and slippery surfaces.

- Keep spray nozzle between 8 to 24 inches away from cleaning surface.
- Be extremely careful if you must use the pressure washer from a ladder, scaffolding or any other relatively unstable location.
- The cleaning area should have adequate slopes and drainage to reduce the possibility of a fall due to slippery surfaces.
- Operate this unit on a stable surface.

**! WARNING**

 Starter and other rotating parts can entangle hands, hair, clothing, or accessories.

- Do not wear loose clothing, jewelry or anything that may be caught in the starter or other rotating parts.
- Tie up long hair and remove jewelry.

**! WARNING**

 High pressure spray can cause paint chips or other particles to become airborne.

- Always wear eye protection when you use this equipment or when you are in the vicinity where the equipment is in use.

**! DANGER**

 Running engine gives off carbon monoxide, an odorless, colorless, poison gas. Some chemicals or detergents may be harmful if inhaled or ingested, causing severe nausea, fainting or poisoning. Breathing carbon monoxide will cause nausea, fainting or death.

- Operate pressure washer ONLY outdoors.
- Use a respirator or mask whenever there is a chance that vapors may be inhaled.
- Read all instructions with mask so you are certain the mask will provide the necessary protection against inhaling harmful vapors.

**! WARNING**

 Unintentional sparking can result in fire or electric shock.



**WHEN ADJUSTING OR MAKING REPAIRS TO YOUR PRESSURE WASHER**

- Disconnect the spark plug wire from the spark plug and place the wire where it cannot contact spark plug.

**! CAUTION**

Excessively high or low operating speeds increase risk of injury and damage to pressure washer.

- Do not tamper with governed speed.
- Do not operate the pressure washer above the rated pressure.

**! WARNING**

 Running engines produce heat. Temperature of muffler and nearby areas can reach or exceed 150°F (65°C). Severe burns can occur on contact.

- Do not touch hot surfaces.
- Allow equipment to cool before touching.

**CAUTION**

High pressure spray may damage fragile items including glass.

- Do not point spray gun at glass when in the jet spray mode.
- Never aim the spray gun at plants.

## KNOW YOUR PRESSURE WASHER

**Read this owner's manual and safety rules before operating your high pressure washer.**

Compare the illustrations with your high pressure washer to familiarize yourself with the locations of various controls and adjustments. Save this manual for future reference.

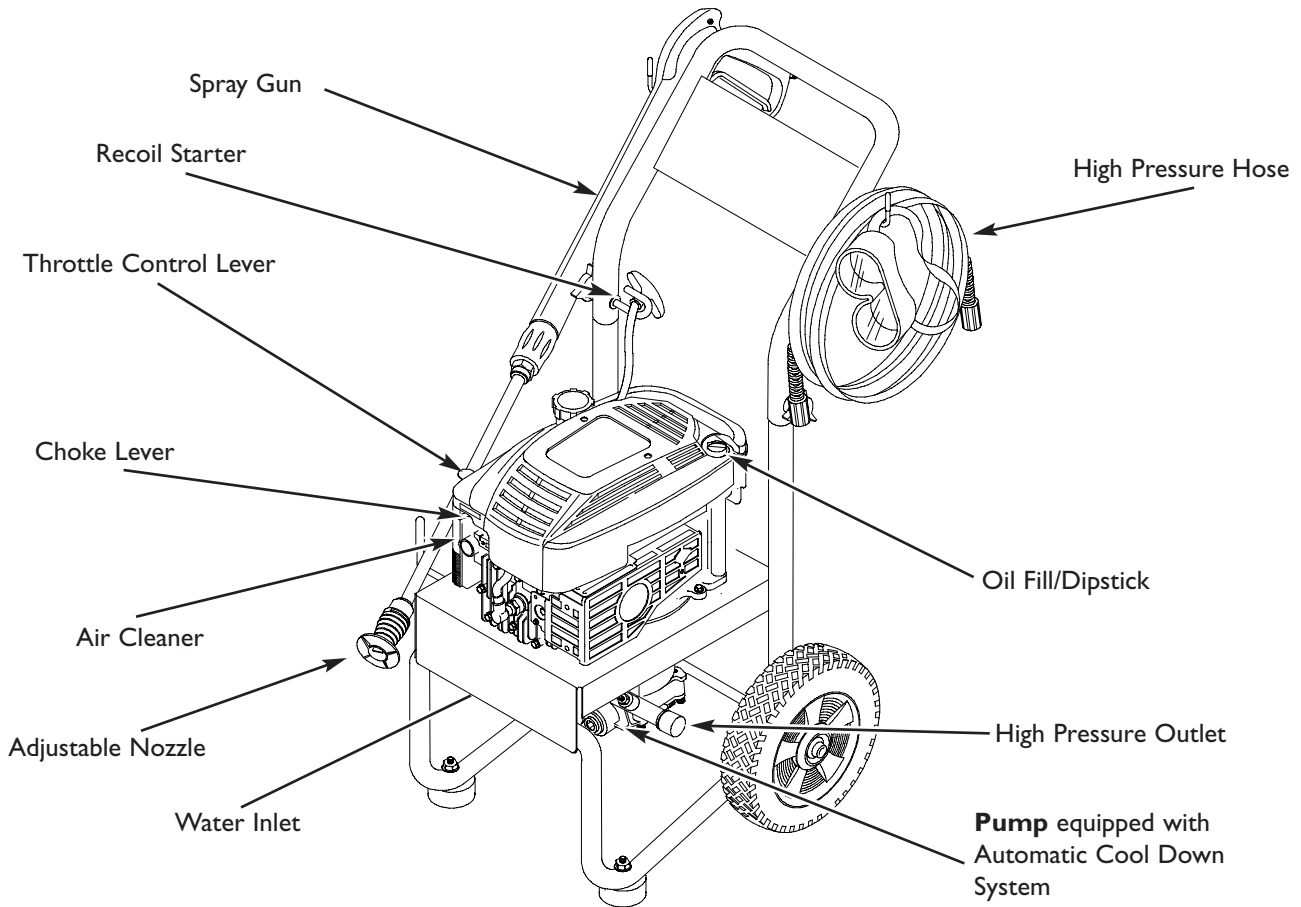

**Adjustable Nozzle** — Always attached to nozzle extension. Adjustable nozzle allows you to adjust spray pressure and spray pattern.

**Air Cleaner** — Dry type filter element limits the amount of dirt and dust that gets in the engine.

**Automatic Cool Down System** — Cycles water through pump when water reaches 125°-155°F. Warm water will discharge from pump onto ground. This system prevents internal pump damage.

**Choke Lever** — Prepares a cold engine for starting.

**High Pressure Hose** — Connect one end to water pump and the other end to spray gun.

**High Pressure Outlet** — Connection for high pressure hose.

**Oil Fill/Dipstick** — Check and fill with oil here.

**Pump** — Develops high pressure.

**Recoil Starter** — Used for starting the engine manually.

**Spray Gun** — Controls the application of water onto cleaning surface with trigger device. Includes safety latch.

**Throttle Control Lever** — Sets engine in starting mode for recoil starter and stops a running engine.

**Water Inlet** — Connection for garden hose.

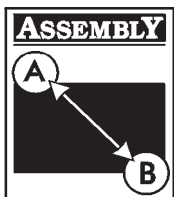

**IMPORTANT:** Read entire owner's manual before you attempt to assemble or operate your new pressure washer.

## REMOVE PRESSURE WASHER FROM CARTON

- Remove the high pressure hose and parts box included with pressure washer.
- Slice two corners at the end of carton from top to bottom so the panel can be folded down flat, then remove all packing material.
- Roll pressure washer out of carton.

### Carton Contents

Items in the carton include:

- Main Unit
- Parts Box (which includes the following):
  - Wireform
  - Goggles
  - Handle Assembly
  - Handle Fastening Hardware
  - High Pressure Hose
  - Owner's Manual
  - Engine Manual
  - Owner's Registration Card
  - Spray Gun
  - Nozzle Extension
  - Oil Bottle
  - Maintenance Kit

If any of the above parts are missing or damaged, call the pressure washer helpline at **1-800-270-1408**.

## PREPARING PRESSURE WASHER FOR USE

If you have any problems with the assembly of your pressure washer or if parts are missing or damaged, call the pressure washer helpline at **1-800-270-1408**.

**To prepare your pressure washer for operation, you will need to perform these tasks:**

- Attach the handle and wire form.
- Add oil to the engine crankcase.
- Add fuel to the fuel tank.
- Connect the high pressure hose to the spray gun and the pump.
- Connect the water supply to the pump.

### Attach Handle and Wire Form

**NOTE:** All assembly operations given in this section will be described from the perspective of assembling the pressure washer from the rear.

- Place the handle onto the handle supports already connected to the main unit. Make sure the holes in the handle align with the holes on the handle supports (Figure 1).

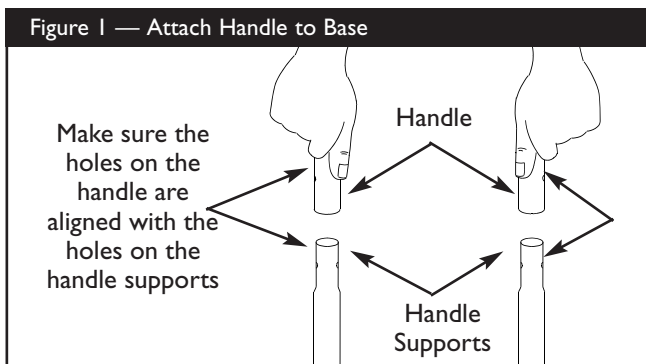

**NOTE:** It may be necessary to move the handle supports from side to side in order to align the handle so it will slide over the handle supports.

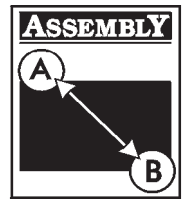

- Insert the carriage bolt through the left hole (from the rear of the unit) and attach a plastic knob. Tighten by hand (Figure 2).

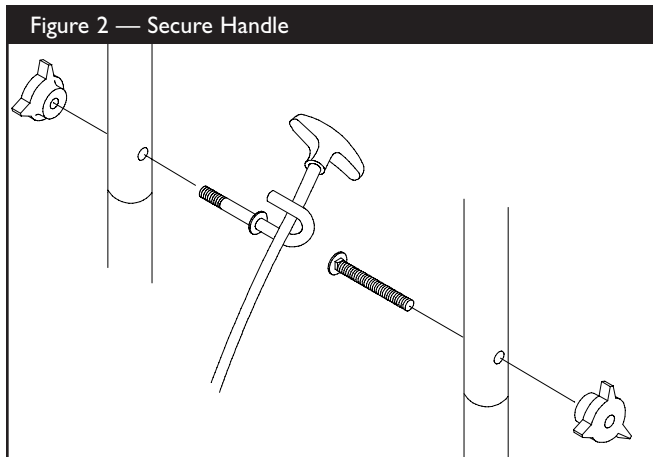

- Insert the carriage hook through the right hole (from the rear of the unit). Pull the recoil handle out slowly. Place the recoil string through the hook and attach the plastic knob. Tighten by hand (Figure 2).
- Insert the wire form with the longer arm positioned on the left. From the rear of the unit, the hook should resemble a “J” (Figure 3).

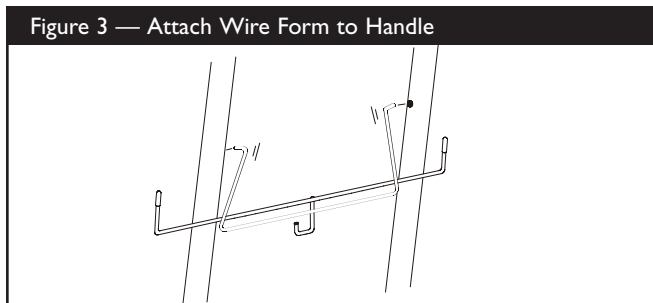

## Add Engine Oil

**IMPORTANT:** Any attempt to crank or start the engine before it has been properly serviced with the recommended oil may result in an engine failure.

- Place pressure washer on a level surface.
- Refer to the engine owners manual to add recommended oil to engine.

**NOTE:** Check oil often during engine break-in. Refer to engine owner’s manual for recommendations.

## Add Gasoline

**WARNING!** Never fill fuel tank indoors. Never fill fuel tank when engine is running or hot. Do Not smoke when filling fuel tank.

**WARNING!** Never fill fuel tank completely full. Provide space for fuel expansion. Wipe away any fuel spillage from engine and equipment before starting.

- Use fresh, clean unleaded automotive gasoline and store in approved, clean, covered containers. Use clean fill funnels. Never use “stale” gasoline left over from last season or gasoline stored for long periods.
- Clean area around fuel fill cap, remove cap.
- Slowly add "UNLEADED" regular gasoline to fuel tank. Use a funnel to prevent spillage. Slowly fill tank to about 1.5" below the bottom of the filler neck (Figure 4).

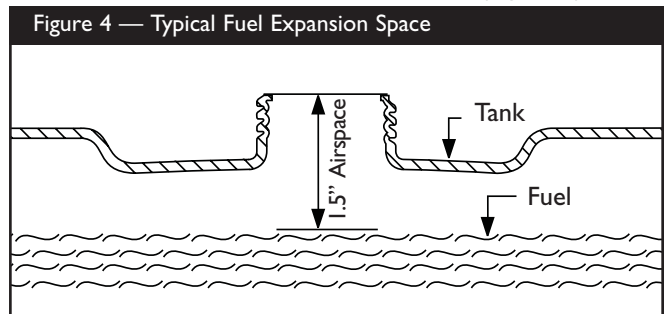

- Install fuel cap and wipe up any spilled gasoline.

## Connect Hose and Water Supply to Pump

**IMPORTANT:** You must attach all hoses before you start the engine. Starting engine without all hoses connected and water supplied will damage the pump.

- Uncoil the high pressure hose and attach one end of the hose to the base of the spray gun (Figure 5). Tighten by hand.

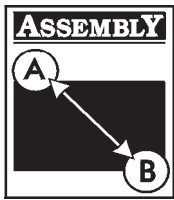
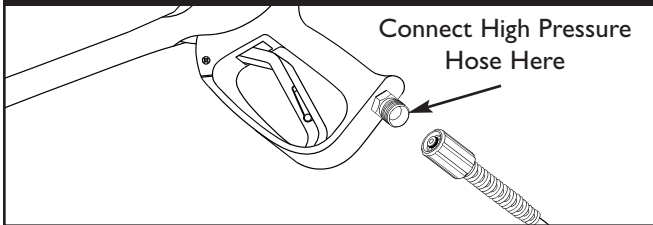
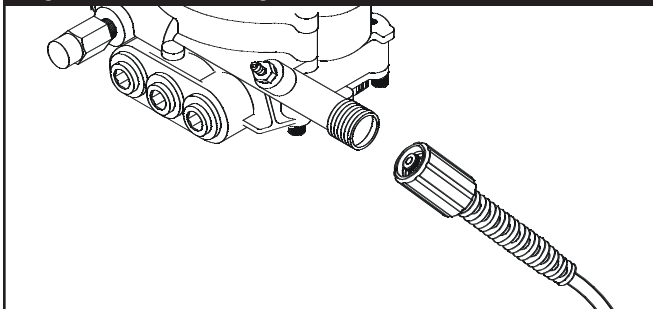

Figure 5 — Connect High Pressure Hose to Spray Gun



- Attach the other end of the high pressure hose to the high pressure fitting on the pump (Figure 6). Tighten by hand.

Figure 6 — Connect High Pressure Hose to Water Outlet



- Before you connect your garden hose to the water inlet, inspect the inlet screen (Figure 7). Clean the screen if it contains debris, replace it if it is damaged. **DO NOT RUN THE PRESSURE WASHER IF THE SCREEN IS DAMAGED.**

Figure 7 — Connect Garden Hose to Water Inlet

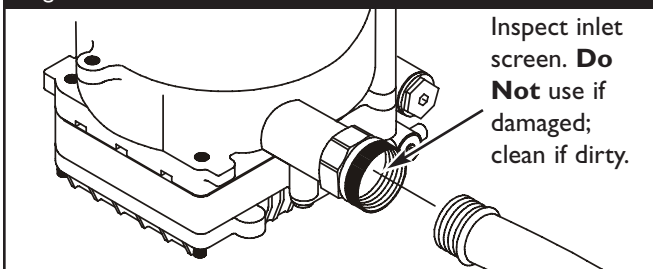

- Run water through your garden hose for 30 seconds to clean out any debris. Turn off water.

**IMPORTANT: Do Not** siphon standing water for the water supply. Use **ONLY** cold water (less than 100°F).

- Connect the garden hose to the water inlet. Tighten by hand (Figure 7).

**CAUTION!** There **MUST** be at least ten feet of unrestricted garden hose between the pressure washer inlet and any flow shut off device, such as a 'Y' shut-off connector or other convenience-type water shut-off valve. Damage to pressure washer resulting from disregarding this warning will not be covered by the warranty.

- Turn **ON** the water and squeeze the trigger on the spray gun to purge the pump system of air and impurities.

**CAUTION!** Before starting the pressure washer, be sure you are wearing adequate eye protection.

## CHECKLIST BEFORE STARTING ENGINE

Review the unit's assembly to confirm you have performed all of the following:

- Make sure the handle and wire form are in place and secure.
- Check that oil has been added to the proper level in the engine crankcase.
- Add the proper gasoline to fuel tank.
- Check for properly tightened hose connections.
- Check to make sure that there are no kinks, cuts, or damage to the high pressure hose.
- Provide a proper water supply (not to exceed 100°F) at an adequate flow.
- Be sure to read "Safety Rules" and "How To Start Your Engine" before using the pressure washer.



## HOW TO USE YOUR PRESSURE WASHER

If you have any problems operating your pressure washer, please call the pressure washer helpline at **1-800-270-1408**.

### How to Start Your Engine

To start your pressure washer for the first time, follow these instructions step-by-step. This starting information also applies if you have let the pressure washer sit idle for at least a day.

- Place the pressure washer in an area close to an outside water source capable of supplying water at a flow rate greater than 2.2 gallons per minute.
- Check that the high pressure hose is tightly connected to the spray gun and to the pump. See “Preparing Pressure Washer for Use” on page 5.
- Make sure unit is in a level position.
- Connect the garden hose to the water inlet on the pressure washer pump. **Turn ON the water.**

**CAUTION! Do Not** run the pump without the water supply connected and turned on. You must follow this caution or the pump will be damaged.

- Squeeze trigger on gun until you have a steady stream of water. This purges the pump of air and impurities.
- Attach nozzle extension to spray gun (Figure 8). Tighten by hand.

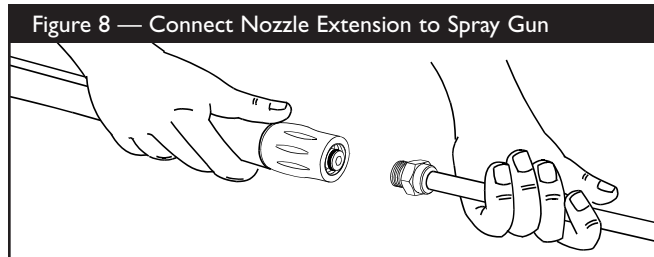

- Position the nozzle in the low pressure mode (slide nozzle forward) and squeeze the trigger on the spray gun to relieve pressure caused by turning ON the water. Water will flow out of the gun in a thin stream. Continue to hold trigger until there is a steady stream of water and no air remains in the system. Release the trigger.
- Engage the safety latch to the spray gun trigger (Figure 9).

Figure 9 — Spray Gun with Safety Latch Engaged

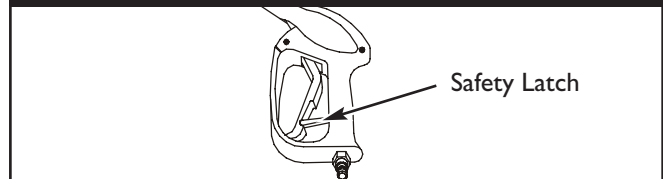

- Move the choke lever to the “**Choke**” position (Figure 10).

Figure 10 — Throttle and Choke Controls

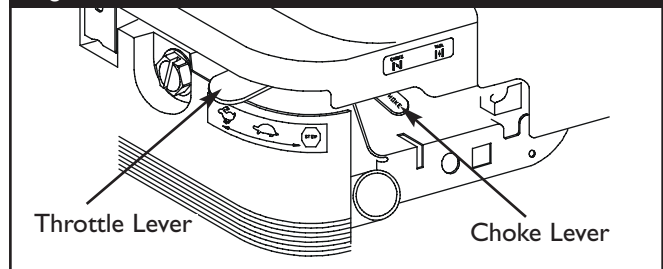

**NOTE:** For a warm engine, be sure the choke lever is in the “**Run**” position.

- Move throttle lever to the “**Fast**” position, shown in Figure 10 as a rabbit. Always keep the throttle in the “**Fast**” position while pressure washing.
- Place your left foot on the lower frame and grasp the handle as shown (Figure 11). Your unit may appear slightly different from that shown here.

Figure 11 — Recommended Engine Starting Posture



- Pull the starter grip handle lightly with your right hand until you feel some resistance, then pull briskly.





- Return the starter grip handle slowly. **Do Not** let rope “snap back” against starter.
- When engine starts, slowly move choke lever to the “Run” position. If engine falters, move choke lever to the “Choke” position, then to the “Run” position.
- If engine fails to start after six pulls, move choke lever to the “Run” position. If engine fires, but does not continue to run, move choke lever to the “Choke” position, then to the “Run” position.

**NOTE:** If the recoil starter is hard to pull, it may be necessary to squeeze the gun trigger to relieve internal pump pressure.

## How to Stop Your Pressure Washer

- Move throttle lever on engine to “Stop” position.
- **Squeeze trigger on the spray gun to relieve pressure in the hose.**

**NOTE:** A small amount of water will squirt out when you release the pressure.

## How to Use the Adjustable Nozzle

You now should know how to **START** your pressure washer and how to **STOP** it. The information in this section will tell you how to adjust the spray pattern and apply detergent or other cleaning chemicals.

**CAUTION!** Never adjust spray pattern when spraying. Never put hands in front of nozzle to adjust spray pattern.

The adjustable nozzle affixed to the nozzle extension permits you to adjust the spray pattern and the spray pressure, as follows:

- Slide the nozzle forward to adjust the spray to low pressure mode (Figure 12). Slide the nozzle backward to achieve high pressure.

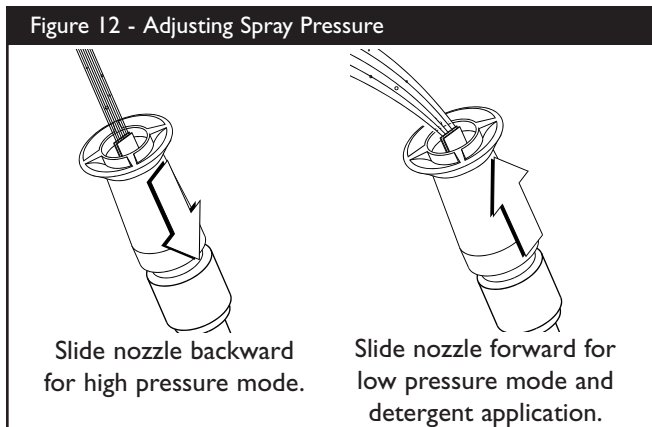

- Point the nozzle down towards a firm surface and press the trigger to test the pattern (Figure 13).

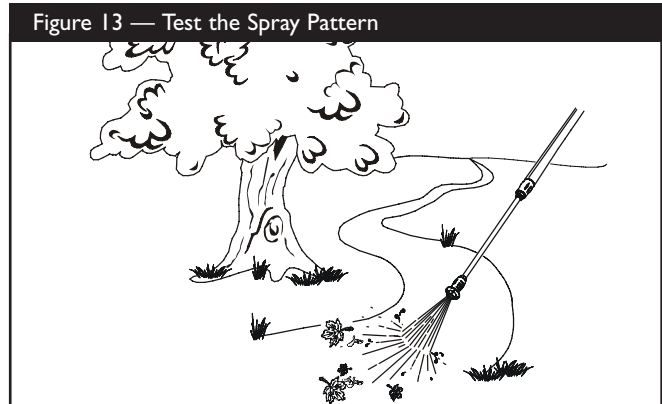

- Twisting the nozzle adjusts the spray pattern from a narrow pattern to a fan pattern (Figure 14).

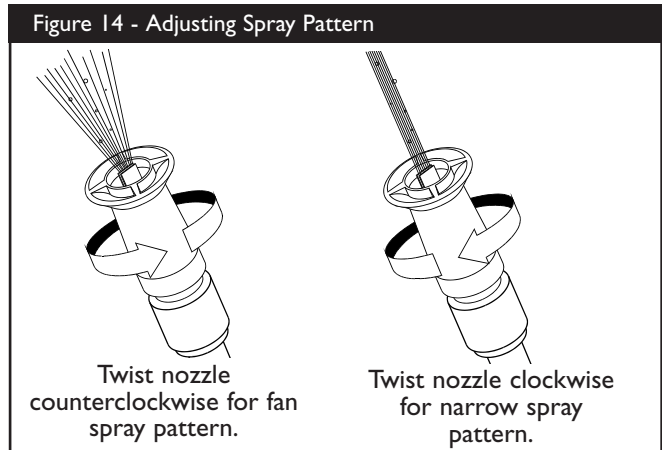

- For most effective cleaning, keep the spray nozzle between 8 to 24 inches away from cleaning surface.
- If you get the spray nozzle too close, especially using high pressure mode, you may damage the surface being cleaned.
- **Do Not** get closer than 8 inches when cleaning tires.

## Applying Detergent with the Adjustable Nozzle

**IMPORTANT:** Use soaps designed specifically for pressure washers. Household detergents could damage the pump.

**IMPORTANT:** You must **attach all hoses** before you start the engine. Starting the engine without all the hoses connected and without the water turned ON will damage the pump.



**To apply detergent, follow these steps:**

- Review the use of adjustable nozzles.
- Prepare detergent solution as required by the job.
- Hang the detergent solution on the hook of the wireform attached to the handle, as shown in Figure 15.

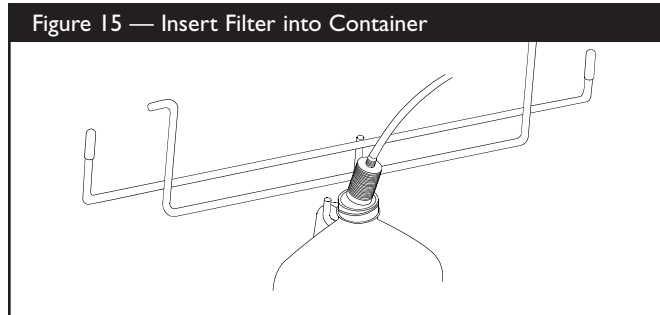

- Place the small filter end of the detergent siphoning tube into the detergent container.

**CAUTION!** Keep the detergent siphoning tube from coming in contact with the hot muffler. This will damage the plastic tube. When inserting the filter into a cleaning solution bottle, route the tube so as to keep it from inadvertently contacting the hot muffler.

- Make sure the garden hose is connected to the water inlet. Check that the high pressure hose is connected to the spray gun and the pump.
- Start the engine and attach nozzle extension.
- Slide the adjustable nozzle forward to low pressure mode. Detergent cannot be applied with the nozzle in high pressure position.
- Apply detergent to a dry surface, starting from the bottom and working up.
- Allow the detergent to “soak in” for 3-5 minutes before washing and rinsing. Reapply as needed to prevent surface from drying.
- For washing, start at lower portion of area to be washed and work upward, using long, even, overlapping strokes.

**Pressure Washer Rinsing**

**WARNING:** Be extremely careful if you must use the pressure washer from a ladder, scaffolding or any other relatively unstable location. Pressure in a running washer builds as you climb. When you press the trigger, the recoil from the initial spray could cause you to fall. The high pressure spray could also cause you to fall if you are too close to the cleaning surface.

**For Rinsing:**

- Slide the nozzle backward to high pressure, press the trigger and wait for the detergent to clear.
- NOTE:** You can also stop detergent from flowing by simply removing detergent siphon tube from bottle.
- Keep the spray gun a safe distance from the area you plan to spray.
  - Apply a high pressure spray to a small area, then check the surface for damage. If no damage is found, it is okay to continue cleaning.
  - Start at the top of the area to be rinsed, working down with same overlapping strokes as you used for washing and applying detergent.

**Automatic Cool Down System  
(Thermal Relief)**

If you run the engine on your pressure washer for 3-5 minutes without pressing the trigger on the spray gun, circulating water in the pump can reach a temperature between 125°–155°F. When the water reaches this temperature, the automatic cool down system engages and cools the pump by **discharging the warm water onto the ground**. This system prevents internal damage to the pump.



## SPECIFICATIONS

- Outlet Pressure** . . . . . 2100 psi
- Flow Rate** . . . . . 2.0 gallons per minute (gpm)
- Detergent** . . . . . Use detergent approved for pressure washers
- Water Supply Temp** . Not to Exceed 100°F
- Automatic Cool** . . . . Will cycle when water
- Down System** . . . . . reaches 125°-155°F
- Shipping Weight** . . . . 65 lbs.

## GENERAL MAINTENANCE RECOMMENDATIONS

The pressure washer warranty does not cover items that have been subjected to operator abuse or negligence. To receive full value from the warranty, the operator must maintain the pressure washer as instructed in this manual.

- Some adjustments will need to be made periodically to properly maintain your pressure washer. Check the spray gun and adjustable nozzle extension assembly for wear.
- All maintenance in this manual and the engine owner's manual should be made at least once each season.
- Once a year you should clean or replace the spark plug, clean or replace the air filter. A new spark plug and clean air filter assure proper fuel-air mixture and help your engine run better and last longer. Please refer to your engine owner's manual for more details.

### BEFORE EACH USE

- Check engine oil level.
- Check water inlet screen for damage.
- Check in-line filter for damage.
- Check high pressure hose for leaks.
- Check detergent siphoning tube and filter for damage.
- Check spray gun and adjustable nozzle extension assembly for leaks.
- Rinse out garden hose to flush out debris **before** connecting to pressure washer.

## PRESSURE WASHER MAINTENANCE

### Check and Clean Inlet Screen

Examine the screen on the water inlet. Clean it if the screen is clogged or replace it if screen is damaged.

### Check High Pressure Hose

The high pressure hose can develop leaks from wear, kinking, or abuse. Inspect the hose each time before using it. Check for cuts, leaks, abrasions or bulging of cover, damage or movement of couplings. If any of these conditions exist, replace the hose immediately.



**CAUTION!** Water spraying from a leak is capable of injecting material into skin. Inspect hose each time before using it. **Never** repair a high pressure hose. Replace it with another hose that exceeds the maximum pressure rating of your pressure washer.

### Check Detergent Siphoning Tube

Examine the filter on the detergent tube and clean if clogged. The tube should fit tightly on the barbed fitting. Examine the tube for leaks or tears. Replace the filter or tube if either is damaged.

### Cleaning Detergent Siphoning Tube

If you used the detergent siphoning tube, you must flush it with clean water before stopping the engine.

- Place the chemical injection siphon/filter in a bucket full of clean water.
- Slide the adjustable nozzle extension forward to the low pressure mode.
- Flush for 1-2 minutes.
- Shut off the engine.

**IMPORTANT:** Simply shutting **OFF** engine will not release pressure in the system. **When the engine has shut down, squeeze the trigger on the spray gun to relieve the pressure in the hose.**



## Check Gun and Adjustable Nozzle Extension

Examine the hose connection to the spray gun and make sure it is secure. Test the trigger by pressing it and making sure it “springs back” into place when you release it. Put the safety latch in the ON position and test the trigger. You should not be able to press the trigger.

## Check In-Line Filter

Refer to Figure 16 and service the in-line filter if it becomes clogged, as follows:

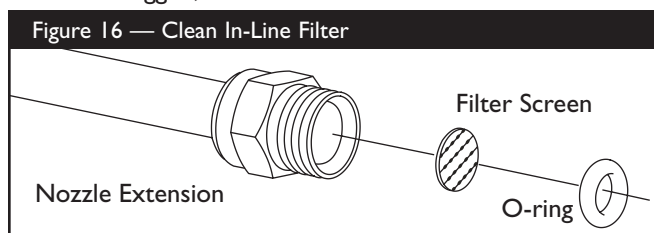

1. Detach spray gun and nozzle extension from high pressure hose. Detach nozzle extension from spray gun and remove o-ring and screen from nozzle extension. Flush the screen, spray gun, and adjustable nozzle extension with clean water to clear debris.
2. If the screen is damaged, the o-ring kit contains a replacement in-line filter screen and an o-ring. If undamaged, reuse screen.
3. Place the in-line filter screen into the threaded end of the nozzle extension. Direction does not matter. Push the screen in with the eraser end of a pencil until it rests flat at the bottom of the opening. Take care to not bend the screen.
4. Place the o-ring into the recess. Push the o-ring snugly against the in-line filter screen.
5. Assemble the nozzle extension to the spray gun, as described earlier in this manual.

## Purge Pump of Air and Contaminants

To remove air from the pump, follow these steps:

- Set up the pressure washer as described in “Preparing Pressure Washer For Use”. Connect the water supply and turn water on.
- Pull the trigger on the spray gun and hold.
- When the water supply is steady and constant, engage the safety latch.

To remove contaminants from the pump, follow these steps:

- Set up the pressure washer as described in “Preparing Pressure Washer For Use”. Connect the water supply and turn water on.
- Start the engine according to instructions in “To Start Your Pressure Washer”.
- Remove nozzle extension from spray gun.
- Squeeze the trigger on the spray gun and hold.
- When the water supply is steady and constant, engage the safety latch and attach the nozzle extension.

## Nozzle Maintenance

A pulsing sensation felt while squeezing the spray gun trigger may be caused by excessive pump pressure. The principal cause of excessive pump pressure is a nozzle clogged or restricted with foreign materials, such as dirt, etc. To correct the problem, immediately clean the nozzle using the tools included with your pressure washer and follow these instructions:

1. Shut off the engine and turn off the water supply.
2. Detach the nozzle extension from the spray gun. Twist the nozzle clockwise to the stream position. Using the supplied 2mm (5/64) allen wrench, remove the nozzle from the end of the nozzle extension (Figure 17).

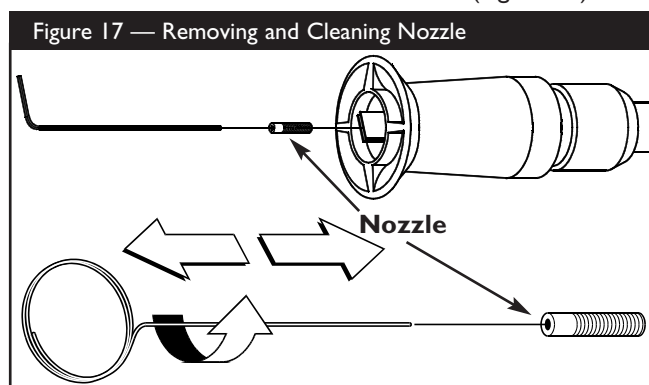

3. Remove the in-line filter from the other end of the nozzle extension.
4. Use the wire included in the kit (or a small paper clip) to free any foreign material clogging or restricting the nozzle (Figure 17).
5. Using a garden hose, remove additional debris by back flushing water through the nozzle extension (Figure 18). Back flush between 30 to 60 seconds. Turn the adjustable nozzle extension to stream spray and move the nozzle from low to high while flushing.



Figure 18 — Backflushing the Nozzle

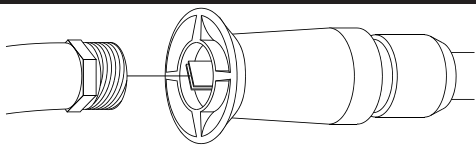

6. Reinstall the nozzle and in-line filter into the nozzle extension. **Do Not** overtighten the nozzle with the allen wrench.
7. Reconnect the nozzle extension to the spray gun.
8. Reconnect the water supply, turn on the water, and start the engine.
9. Test the pressure washer by operating with nozzle in the high and in the low positions.

## O-Ring Maintenance

Through the normal operation of your pressure washer, o-rings, which keep the connections of the hoses and spray gun tight and leak-free, may become worn or damaged.

An O-Ring Maintenance Kit is provided with your pressure washer which includes replacement o-rings, rubber washer and water inlet filter. Refer to the instruction sheet provided in the kit to service your unit's o-rings. Note that not all of the parts in the kit will be used on your unit.

### To remove a worn or damaged o-ring:

- Use a small flathead screwdriver to get underneath the o-ring and pry it off.

## ENGINE MAINTENANCE

See the engine owner's manual for instructions on how to properly maintain the engine.



**CAUTION!** Avoid prolonged or repeated skin contact with used motor oil. Used motor oil has been shown to cause skin cancer in certain laboratory animals. Thoroughly wash exposed areas with soap and water.

KEEP OUT OF REACH OF CHILDREN. DON'T POLLUTE. CONSERVE RESOURCES. RETURN USED OIL TO COLLECTION CENTERS.

## PREPARING THE UNIT FOR STORAGE

Water should not remain in the unit for long periods of time. Sediments or minerals can deposit on pump parts and "freeze" pump action. If you do not plan to use the pressure washer for more than 30 days, follow this procedure:

1. Flush detergent siphoning tube by placing the filter into a pail of clean water while running pressure washer in low pressure mode (adjustable nozzle in the forward position). Flush for one to two minutes.
2. Shut off the engine and let it cool, then remove high pressure and garden hoses. Disconnect spark plug wire from spark plug.
3. Empty the pump of all pumped liquids by pulling the recoil handle about 6 times. This should remove most of the liquid in the pump.
4. Use Generac brand PumpSaver to prevent corrosion build up and freezing of pump.
5. Store unit in a clean, dry area.

## Protecting the Pump

To protect the pump from damage caused by mineral deposits or freezing, use the Generac PumpSaver to treat pump. This prevents freeze damage and lubricates pistons and seals.

**NOTE:** Generac PumpSaver is available as an optional accessory. It is not included with the pressure washer.

**CAUTION!** You must protect your unit from freezing temperatures. Failure to do so will permanently damage your pump and render your unit inoperable. Freeze damage is not covered under warranty.



**CAUTION!** Read and follow all cautions and warnings on the PumpSaver can label. Always wear eye protection when using PumpSaver.

To use PumpSaver, make sure the pressure washer is turned off and disconnected from supply water. Read and follow all instructions and warnings given on the PumpSaver container.

**NOTE:** PumpSaver will drip from pump after treatment and will stain wood and concrete.

**NOTE:** If PumpSaver is not available, draw RV antifreeze (non-alcohol) into the pump by pouring the solution into a 3-foot section of garden hose connected to inlet adapter and pulling recoil handle twice.

## STORING THE ENGINE

See the engine owner's manual for instructions on how to properly prepare the engine for storage.





## TROUBLESHOOTING

Problem	Cause	Correction
<b>Pump has following problems: failure to produce pressure, erratic pressure, chattering, loss of pressure, low water volume.</b>	<ol style="list-style-type: none"> <li>1. Nozzle in low pressure mode.</li> <li>2. Water inlet is blocked.</li> <li>3. Inadequate water supply.</li> <li>4. Inlet hose is kinked or leaking.</li> <li>5. Clogged inlet hose strainer.</li> <li>6. Water supply is over 100°F.</li> <li>7. High pressure hose is blocked or leaks.</li> <li>8. Gun leaks.</li> <li>9. Nozzle is obstructed.</li> <li>10. Pump is faulty.</li> </ol>	<ol style="list-style-type: none"> <li>1. Pull nozzle backward for high pressure mode.</li> <li>2. Clear inlet.</li> <li>3. Provide adequate water flow.</li> <li>4. Straighten inlet hose, patch leak.</li> <li>5. Check and clean inlet hose strainer.</li> <li>6. Provide cooler water supply.</li> <li>7. Clear blocks in outlet hose.</li> <li>8. Replace gun.</li> <li>9. Clean nozzle.</li> <li>10. Contact Generac service facility.</li> </ol>
<b>Detergent fails to mix with spray.</b>	<ol style="list-style-type: none"> <li>1. Detergent siphoning tube is not submerged.</li> <li>2. Chemical filter is clogged.</li> <li>3. Dirty in-line filter.</li> <li>4. Nozzle is in high pressure mode.</li> </ol>	<ol style="list-style-type: none"> <li>1. Insert detergent siphoning tube into detergent.</li> <li>2. Clean or replace filter/detergent siphoning tube.</li> <li>3. See "Check In-Line Filter" on page 12.</li> <li>4. Push nozzle forward for low pressure mode.</li> </ol>
<b>Engine runs good at no-load but "bogs" when load is added.</b>	Engine speed is too slow.	Move throttle control to FAST position. If engine still "bogs down", contact Briggs service facility.
<b>Engine will not start; or starts and runs rough.</b>	<ol style="list-style-type: none"> <li>1. Low oil level.</li> <li>2. Dirty air cleaner.</li> <li>3. Out of gasoline.</li> <li>4. Stale gasoline.</li> <li>5. Spark plug wire not connected to spark plug.</li> <li>6. Bad spark plug.</li> <li>7. Water in gasoline.</li> <li>8. Overchoking.</li> <li>9. Excessively rich fuel mixture.</li> <li>10. Intake valve stuck open or closed.</li> <li>11. Engine has lost compression.</li> </ol>	<ol style="list-style-type: none"> <li>1. Fill crankcase to proper level.</li> <li>2. Clean or replace air cleaner.</li> <li>3. Fill fuel tank.</li> <li>4. Drain gas tank; fill with fresh fuel.</li> <li>5. Connect wire to spark plug.</li> <li>6. Replace spark plug.</li> <li>7. Drain gas tank; fill with fresh fuel.</li> <li>8. Open choke fully and crank engine.</li> <li>9. Contact Briggs service facility.</li> <li>10. Contact Briggs service facility.</li> <li>11. Contact Briggs service facility.</li> </ol>
<b>Engine shuts down during operation.</b>	Out of gasoline.	Fill fuel tank.
<b>Engine lacks power.</b>	Dirty air filter.	Replace air filter.
<b>Engine "hunts" or falters.</b>	Choke is opened too soon.	Move choke to halfway position until engine runs smoothly.

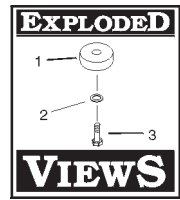

# EXPLODED VIEW — UNIT

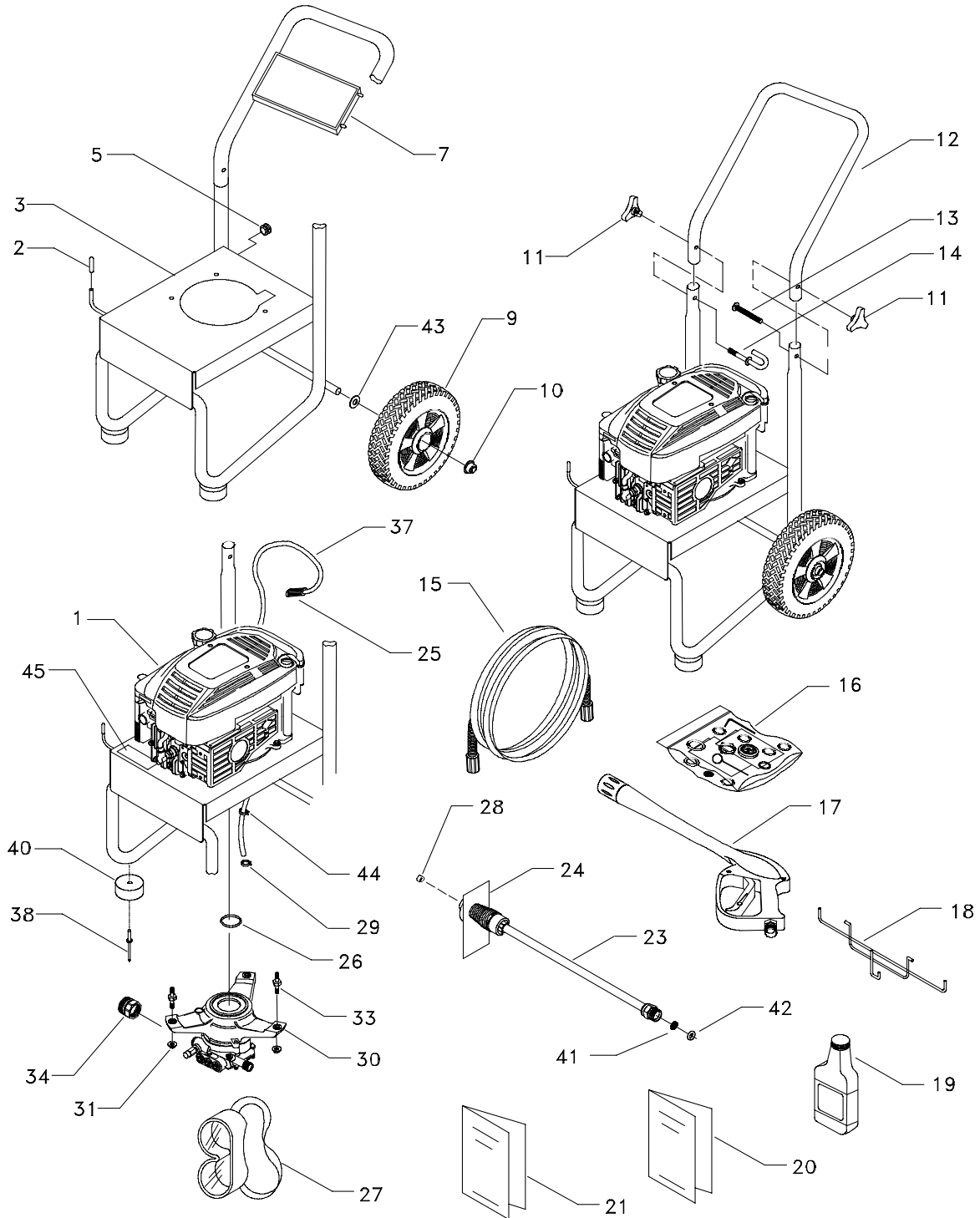



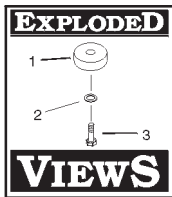

## PARTS LIST — UNIT

Item	Part #	Qty.	Description
1	NSP	1	ENGINE
2	B1460GS	1	CAP, Vinyl Black
3	AB5697GS	1	BASE
5	30809GS	1	GROMMET, Chem Hose
7	191049GS	1	ASSY, Billboard, 01439
9	B2142GS	2	TIRE
10	190146GS	2	PUSHNUT
11	97178GS	2	KNOB, PW Handle
12	AB1945GS	1	HANDLE
13	31669GS	1	BOLT, Carriage
14	B1730GS	1	BOLT, Eye
15	B5693GS	1	HOSE
16	190862GS	1	KIT, Maintenance
17	B3263GS	1	GUN, High Pressure
18	B1953AGS	1	WIREFORM
19	BB3061BGS	1	OIL
20	B5700GS	1	MANUAL, Owners
21	191457GS	1	MANUAL, Engine
23	B3335GS	1	WAND, Adjustable Nozzle
24	97566GS	1	TAG, Hang, Nozzle
25	A1041GS	1	FILTER, Chemical Hose
26	98300GS	1	SEAL, Engine Donut
27	87815GS	1	GOGGLES, Safety
28	21761GS	1	NOZZLE, Yellow Replacement
29	48031GGS	1	CLAMP, Hose Band
30	B3468AGS	1	ASSY, Pump (see pages 18-19)
31	B1880GS	3	NUT, with Washer
33	B1735GS	3	STUD, Double Ended
34	21424GS	1	CONNECTOR, Garden Hose
36	52858GS	3	NUT, Locking Flange
37	A1040BGS	1	HOSE, Chemical
38	188194GS	2	RIVET, Blind
40	191413GS	2	VIBE MOUNT, with Washer
41	B4224GS	1	SCREEN, Gun Inlet
42	97837GS	1	O-RING, Hi - Pressure
43	49808GS	2	WASHER, Flat
44	48031BGS	1	CLAMP, Hose Band
45	187952GS	1	DECAL, Cool Down

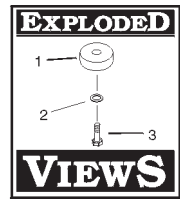

# EXPLODED VIEW — PUMP

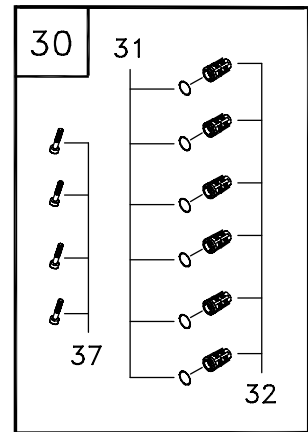
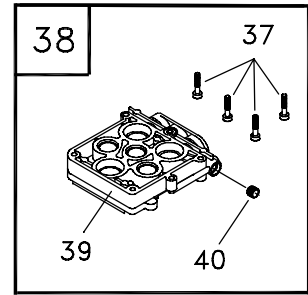
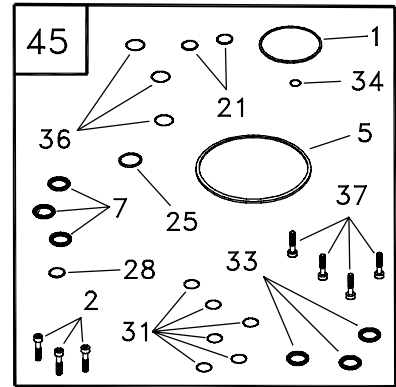
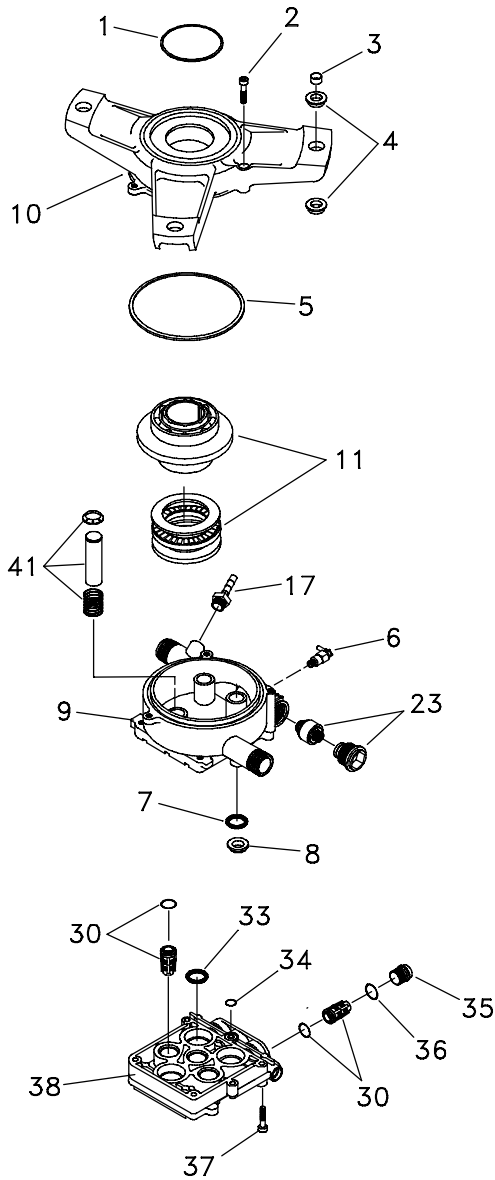
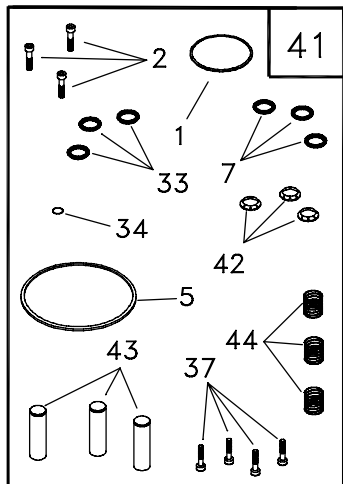
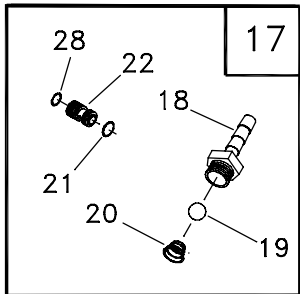
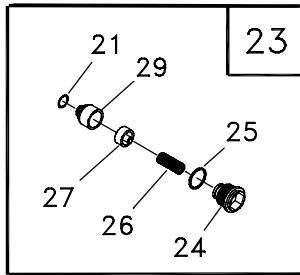
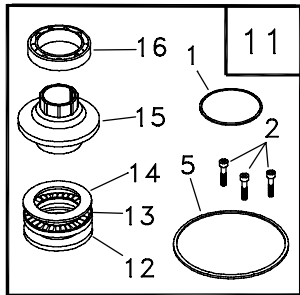

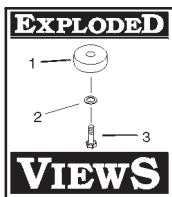

## PARTS LIST — PUMP

Item	Part #	Qty.	Description	Item	Part #	Qty.	Description
1	98300GS	1	SEAL, Engine Donut	33	B5433GS	3	SEAL, Double-Lip
2	97962GS	3	CAPSCREW, Socket Head	34	97837GS	1	O-RING, Hi-Pressure Transfer
3	96795GS	3	SLEEVE, Grommet Spacer	35	97841GS	3	CAP, Outlet Check Valve
4	21429GS	6	BUSHING, Rubber Mount	36	97840GS	3	O-RING, Outlet CV Cap
5	97835GS	1	O-RING, Housing Seal	37	40946GS	4	CAPSCREW, Socket Head
6	21783GS	1	THERMAL RELIEF, GPW-EG	38	B4186GS	0	KIT, HEAD CASTING SFG
7	93680GS	3	SEAL, Oil Piston	37	.....	4	CAPSCREW, Socket Head
8	97831GS	3	SPACER, Pilot	39	.....	1	HEAD, Pump
9	B2702GS	1	HOUSING, Piston	40	.....	1	PLUG, W/VIRB
10	98227GS	1	ADAPTER, Engine	41	B2312GS	0	KIT, PISTON & SPRING
11	B2310GS	0	KIT, AXIAL CAM SERV	1	.....	1	SEAL, Engine Donut
1	.....	1	SEAL, Engine Donut	2	.....	3	CAPSCREW, Socket Head
2	.....	3	CAPSCREW, Socket Head	7	.....	3	SEAL, Oil Piston
5	.....	1	O-RING, Housing Seal	5	.....	1	O-RING, Housing Seal
12	.....	1	WASHER, Brg.	33	.....	3	SEAL, Double-Lip
13	.....	1	ASSY, Brg. Cage	34	.....	1	O-RING, High Pressure Transfer
14	.....	1	WASHER, Brg.	37	.....	4	CAPSCREW, Socket Head
15	.....	1	CAM, Axial	42	.....	3	RETAINER, Piston Spring
16	.....	1	BEARING, Ball	43	.....	3	PISTON
17	185287GS	0	KIT, CHEM INJECT	44	.....	3	SPRING, Piston Return
18	.....	1	FITTING, Chem Inject	45	B1933GS	0	KIT, O-RING/SEAL SERV
19	.....	1	BALL, Chem Inject	1	.....	1	SEAL, Engine Donut
20	.....	1	SPRING, Chem Inject	2	.....	3	CAPSCREW, Socket Head
21	.....	1	O-RING, Venturi & Seat, Black	5	.....	1	O-RING, Housing Seal
22	.....	1	VENTURI, Chem Inject	7	.....	3	SEAL, Oil Piston
28	.....	1	O-RING, Venturi, Yellow	21	.....	2	O-RING, Venturi & Seat, Black
23	187879GS	0	KIT, UNLOADER	25	.....	1	O-RING, Unloader Cap
21	.....	1	O-RING, Venturi & Seat, Black	28	.....	1	O-RING, Venturi, Yellow
24	.....	1	CAP, Unloader	31	.....	6	O-RING, Check Valve
25	.....	1	O-RING, Unloader Cap	33	.....	3	SEAL, Double-Lip
26	.....	1	SPRING, Unloader	34	.....	1	O-RING, High Pressure Transfer
27	.....	1	ASSY, Piston, Unloader	36	.....	3	O-RING, Outlet CV Cap
29	.....	1	SEAT, Unloader	37	.....	4	CAPSCREW, Socket Head
30	B3513GS	0	KIT, CHECK VALVES				
31	.....	6	O-RING, Check Valve				
32	.....	6	ASSY, Check Valve				
37	.....	4	CAPSCREW, Socket Head				

Item numbers 11, 17, 23, 30, 38, 41, and 45 are service kits and include all parts shown within the box. Certain parts may only be available as components of a kit.

## LIMITED WARRANTY

### GENERAC PORTABLE PRODUCTS OWNER WARRANTY POLICY Effective October 1, 2001

#### LIMITED WARRANTY

"Generac Portable Products, LLC will repair or replace, free of charge, any part, or parts of the equipment that are defective in material or workmanship or both. Transportation charges on parts submitted for repair or replacement under this Warranty must be borne by purchaser. This warranty is effective for the time periods and subject to the conditions provided for in this policy. For warranty service, find the nearest Authorized Service Dealer in our dealer locator map at [www.generac-portables.com](http://www.generac-portables.com) or call 1-877-544-0982. THERE IS NO OTHER EXPRESS WARRANTY. IMPLIED WARRANTIES, INCLUDING THOSE OF MERCHANTABILITY AND FITNESS FOR A PARTICULAR PURPOSE, ARE LIMITED TO THE TIME PERIOD SPECIFIED, OR TO THE EXTENT PERMITTED BY LAW ANY AND ALL IMPLIED WARRANTIES ARE EXCLUDED. LIABILITY FOR CONSEQUENTIAL DAMAGES UNDER ANY AND ALL WARRANTIES ARE EXCLUDED TO THE EXTENT EXCLUSION IS PERMITTED BY LAW. Some states do not allow limitations on how long an implied warranty lasts, and some states do not allow the exclusion or limitation of incidental or consequential damages, so the above limitation and exclusion may not apply to you. This warranty gives you specific legal rights and you may also have other rights which vary from state to state and country to country."

#### WARRANTY PERIOD\*

PRODUCTS**	CONSUMER USE	COMMERCIAL USE
Portable Generator (Side Valve Engine Powered)	1 year	90 days
Portable Generator (Overhead Valve Engine Powered)	2 years (2nd year parts only)	1 year
Electric Powered Pressure Washer	1 year	None
Gasoline Powered Pressure Washer	1 year	90 days

\* The warranty period begins on the date of purchase by the first retail consumer or commercial end user, and continues for the period of time stated in the table above. "Consumer use" means personal residential household use by a retail consumer. "Commercial use" means all other uses, including use for commercial, income producing or rental purposes. Once equipment has been used commercially, it shall thereafter be considered to be in commercial use for purposes of this warranty. Used equipment, demonstration equipment and equipment used for prime power in place of a utility are not warranted. Accessory parts such as guns, hoses, wands and nozzles are excluded from the product warranty.

\*\* The gasoline engine and starting batteries are warranted solely by the manufacturers of those products.

**WARRANTY REGISTRATION IS NOT NECESSARY TO OBTAIN WARRANTY ON GENERAC PORTABLE PRODUCTS EQUIPMENT. SAVE YOUR PROOF OF PURCHASE RECEIPT. IF YOU DO NOT PROVIDE PROOF OF THE INITIAL PURCHASE DATE AT THE TIME WARRANTY SERVICE IS REQUESTED, THE MANUFACTURING DATE OF THE EQUIPMENT WILL BE USED TO DETERMINE THE WARRANTY PERIOD.**

#### About your equipment warranty:

Generac Portable Products welcomes warranty repair and apologizes to you for being inconvenienced. Any Authorized Service Dealer may perform warranty repairs. Most warranty repairs are handled routinely, but sometimes requests for warranty service may not be appropriate. For example, warranty would not apply if equipment damage occurred because of misuse, lack of routine maintenance, shipping, handling, warehousing or improper installation. Similarly, warranty is void if the serial number of the equipment has been removed or the equipment has been altered or modified.

If a customer differs with the decision of the Service Dealer, an investigation will be made to determine whether the warranty applies. Ask the Service Dealer to submit all supporting facts to its Distributor for review. If the Distributor decides that the claim is justified, the customer will be fully reimbursed for those items that are defective. To avoid misunderstandings that might occur between the customer and the Dealer, listed below are some of the causes of equipment failure that the warranty does not cover:

#### Normal wear:

Outdoor Power Equipment, like all mechanical devices, needs periodic parts, service and replacement to perform well. This warranty does not cover repair when normal use has exhausted the life of a part or the equipment.

#### Installation and Maintenance:

This warranty does not apply to equipment or parts that have been subjected to improper or unauthorized installation or alteration, misuse, negligence, accident, overloading, overspeeding, improper maintenance, repair or storage so as, in Generac Portable Products' judgment, to adversely affect its performance and reliability. This warranty also does not cover normal maintenance such as adjustments, fuel system cleaning and obstruction (due to chemical, dirt, carbon or lime, etc.).

#### Other Exclusions:

Also excluded from this warranty are wear items such as quick couplers, oil gauges, belts, o-rings, filters, pump packing, etc., pumps which have been run without water supplied or damage or malfunctions resulting from accidents, abuse, modifications, alterations, or improper servicing or freezing or chemical deterioration.

**Warranty is available only through service dealers authorized by Generac Portable Products. This warranty does not apply to service by any other entity.**

**You may locate your nearest Authorized Generac Portable Product Service Dealer in our dealer locator map at [www.generac-portables.com](http://www.generac-portables.com) or call 1-877-544-0982.**

Generac Portable Products Are Made Under One Or More Of The Following Patents: (Other Patents Pending)

5902094

5823752

5718255

5890413

**Generac Portable Products, LLC**  
**Jefferson, Wisconsin U.S.A.**