

GENERAC®
Portable Products

2500PSI

Electric Start High Pressure Washer Owner's Manual

**Problems?
Questions?**
Before taking your unit
back to the store,
call the pressure washer
helpline at
1-800-270-1408
M-F 8-5 CT



Model No. 1443-0 (2,500 PSI High Pressure Washer) Manual No. B5786 Revision 2 (8/14/2000)

Visit our Generac website: www.generac-portables.com



This is the safety alert symbol. It is used to alert you to potential personal injury hazards. Obey all safety messages that follow this symbol to avoid possible injury or death.



EQUIPMENT DESCRIPTION

CONGRATULATIONS on your purchase of a GENERAC high pressure washer. It has been designed, engineered and manufactured to give you the best possible dependability and performance.

This manual contains information for an electric start high pressure washer that operates at 2,500 PSI at a flow rate of 3.0 gallons per minute. This high quality professional/commercial system features large 10" wheels, a pump equipped with an automatic cool down system, a chemical injection system, quick connect nozzles, safety goggles, a heavy duty 25' hose, and more.

Please read and retain this manual. The instructions will enable you to assemble your unit, and maintain your high pressure washer properly.

Every effort has been made to ensure that the information in this manual is both accurate and current. However, Generac reserves the right to change, alter or otherwise improve the product and its documentation at any time without prior notice.

Should you experience any problem you cannot easily fix, call the pressure washer helpline at **1-800-270-1408**.

CUSTOMER RESPONSIBILITIES

- Read and observe the safety rules.
- Follow regular schedule in maintaining, caring for and using your high pressure washer.
- For off-season storage, review "Preparing The Unit For Storage" on page 16.

SAFETY RULES

CAUTION! When setting up, transporting, adjusting or making repairs to your high pressure washer, always disconnect the spark plug wire from the spark plug and place the wire where it cannot contact spark plug.

DANGER! Engine exhaust contain DEADLY carbon monoxide gas. This dangerous gas, if breathed in sufficient concentrations, can cause unconsciousness or even death. Operate this equipment only in the open air where adequate ventilation is available.

DANGER! Gasoline is highly FLAMMABLE and its vapors are EXPLOSIVE. **Do Not** permit smoking, open flames, sparks or heat in the vicinity while handling gasoline. Avoid spilling gasoline on a hot engine. Allow unit to cool for 2 minutes before refueling. Comply with all laws regulating storage and handling of gasoline.

Read this manual carefully and become familiar with your pressure washer. Know its applications, its limitations, and any hazards involved.

	WARNING:	
The engine exhaust from this product contains chemicals known to the State of California to cause cancer, birth defects, or other reproductive harm.		

- Locate this pressure washer in areas away from combustible materials, combustible fumes or dust.
- The high pressure equipment is designed to be used with Generac authorized parts **ONLY**. If you use this equipment with parts that do not comply with minimum specifications, the user assumes all risks and liabilities.
- **Do Not** allow CHILDREN to operate the pressure washer at any time.
- Always be certain the spray gun, nozzles and accessories are correctly attached.
- **Do Not** wear loose clothing, jewelry or anything that may be caught in the starter or other rotating parts.



- Before starting the pressure washer in cold weather, check all parts of the equipment and be sure ice has not formed there.
 - Units with broken or missing parts, or without protective housing or covers, should **Never** be operated.
 - Use a respirator or mask whenever there is a chance that vapors may be inhaled. Read all instructions with mask so you are certain the mask will provide the necessary protection against inhaling harmful vapors.
 - Always wear eye protection when you use this equipment or when you are in the vicinity where the equipment is in use.
 - The cleaning area should have adequate slopes and drainage to reduce the possibility of a fall due to slippery surfaces.
 - **Do Not** by-pass any safety device on this machine.
 - Operate and store this unit on a stable surface.
 - Some chemicals or detergents may be harmful if inhaled or ingested, causing severe nausea, fainting or poisoning. The harmful elements may cause property damage or severe injury.
 - **Do Not** spray flammable liquids.
 - **Never** allow any part of the body to come in contact with the fluid stream. **Do Not** come in contact with a fluid stream created by leaks in high pressure hose.
 - High pressure spray can cause paint chips or other particles to become airborne.
 - **Do Not** operate the pressure washer above the rated pressure.
 - High pressure spray may damage fragile items including glass. **Do Not** point spray gun at glass when in the jet spray mode.
 - **Do Not** secure the spray gun in the (open) position.
 - Keep the hose connected to machine or the spray gun while the system is pressurized. Disconnecting the hose while the unit is pressurized is dangerous.
 - Keep water spray away from electric wiring or fatal electric shock may result.
 - **Never** use a spray gun which does not have a trigger lock or trigger guard in place and in working order.
 - **Never** aim the spray gun at people, animals or plants. The high pressure stream of water that this equipment produces can pierce skin and its underlying tissues, leading to serious injury and possible amputation.
 - Hold the spray gun firmly in your hand before you start the unit. Failure to do so could result in an injury from a whipping spray gun. **Do Not** leave the spray gun unattended while the machine is running.
 - **Never** move the machine by pulling on the high pressure hose. Use the handle provided on the unit.
 - High pressure hose can develop leaks from wear, kinking, abuse, etc. Water spraying from a leak is capable of injecting material into skin. Inspect hose each time before using it. Check all hoses for cuts, leaks, abrasions or bulging of cover, or damage or movement of couplings. If any of these conditions exist, replace hose immediately. **Never** repair high pressure hose. Replace it with another hose that exceeds maximum pressure rating of your unit.
 - Check the fuel system for leaks or signs of deterioration, such as chafed or spongy hose, loose or missing clamps, or damaged tank or cap. Correct all defects before operating the pressure washer.
 - Operate engine **ONLY** at governed speed. Running the engine at excessive speeds increases the hazard of personal injury. **Do Not** tamper with parts which may increase or decrease the governed speed.
 - The muffler and engine heat up during operation and remain hot immediately after shutting it down. Avoid contact with a hot muffler or engine as you could be severely burned.
 - The muffler and air cleaner must be installed and in good condition before operating the pressure washer. These components act as spark arresters if the engine backfires.
- In the State of California a spark arrester is required by law (Section 4442 of the California Public Resources Code). Other states may have similar laws. Federal laws apply on federal lands.
- NOTE:** If you equip the muffler with a spark arrester, it must be maintained in effective working order. You can order a spark arrester through your authorized Briggs and Stratton service dealer.



KNOW YOUR PRESSURE WASHER

Read this owner's manual and safety rules before operating your high pressure washer.

Compare the illustrations with your high pressure washer to familiarize yourself with the locations of various controls and adjustments. Save this manual for future reference.

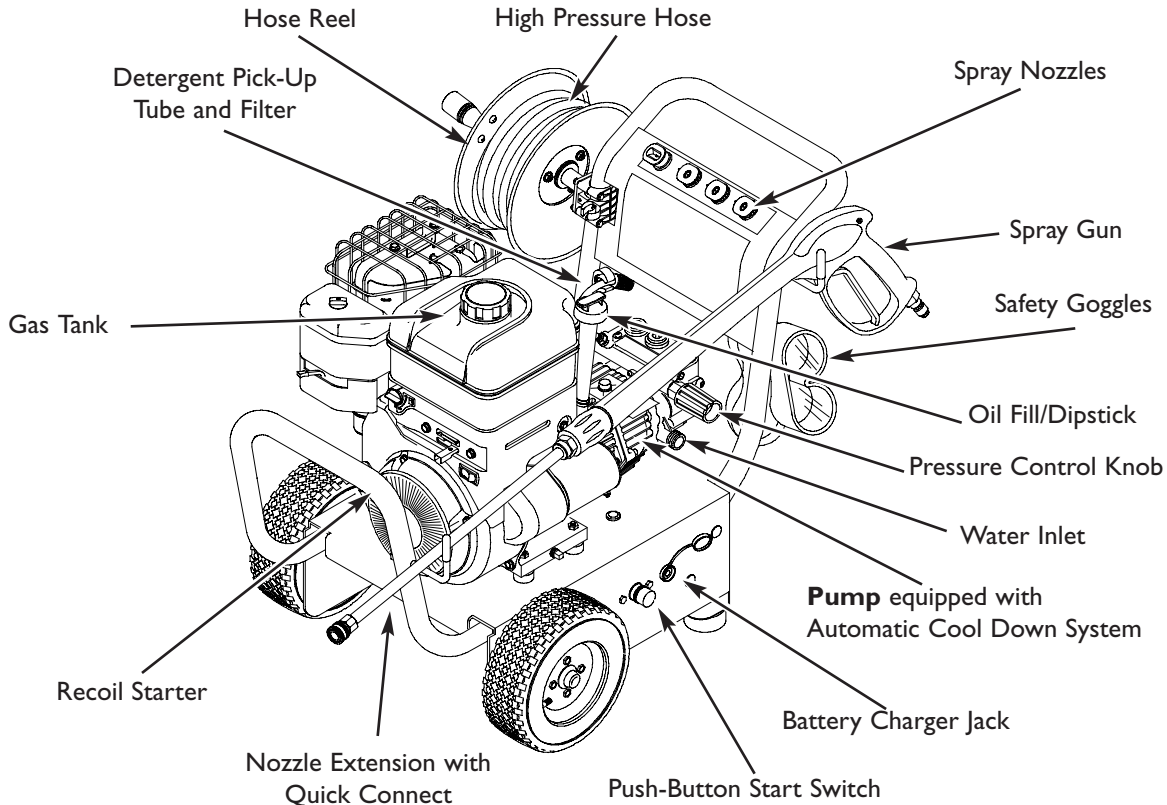

Automatic Cool Down System — Cycles water through pump when water reaches 140°-145°F. Warm water will discharge from pump onto ground. This system prevents internal pump damage.

Battery Charger Jack — Plug battery charger into jack to keep the battery charged and ready for use.

Detergent Pick-Up Tube and Filter — Used to siphon detergent from chemical bottle to low pressure water stream.

Gas Tank — Fill tank with regular unleaded gasoline. Always leave room for fuel expansion.

High Pressure Hose — Connect one end to the water pump and the other end to the spray gun.

Hose Reel — Used for storing hose while unit is not in use. Hose must be detached from unit and spray gun before storage.

Nozzle Extension with Quick Connect — Allows you to switch between four different spray nozzles.

Oil Fill/Dipstick — Used to check and fill with oil here.

Pressure Control Knob — Varies the pressure of the high pressure spray.

Pump — Develops high pressure.

Push-Button Start Switch — Push button for easy engine starting.

Recoil Starter — Use for starting the engine manually.

Safety Goggles — Always use the enclosed goggles or other eye protection when running your pressure washer.

Spray Gun — Controls the application of water onto cleaning surface with trigger device. Includes safety latch.

Spray Nozzles — Chemical injection, 0°, 15°, and 40°: for various cleaning applications.

Water Inlet — Connect garden hose here.

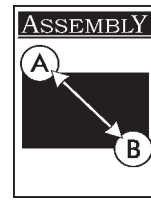

Read entire owner's manual before you attempt to assemble or operate your new pressure washer.

REMOVE PRESSURE WASHER FROM CARTON

- Remove the handle, hose reel box and parts box included with pressure washer.
- Slice two corners at the end of carton from top to bottom so the panel can be folded down flat, then remove all packing material.
- Roll pressure washer out of carton.

Carton Contents

Items in the carton include:

- Main Unit
- Handle
- Hose Reel box containing:
 - Hose Reel
 - Parts bag containing clamps, hose clip, handle, hose reel mounting hardware
- Parts box containing:
 - Bag with 4 multi-colored nozzles
 - Safety goggles
 - High pressure hose
 - Nozzle cleaning kit
 - Nozzle extension with Quick-Connect fitting
 - Engine oil
 - O-Ring maintenance kit
 - Owner's manual
 - Engine manual
 - Handle hardware and detergent hose clip
 - Spray gun
 - Battery charger

If any of the above parts are missing or damaged, call the pressure washer helpline at **1-800-270-1408**.

PREPARING PRESSURE WASHER FOR USE

If you have any problems with the assembly of your pressure washer or if parts are missing or damaged, call the pressure washer helpline at **1-800-270-1408**.

To prepare your pressure washer for operation, you will need to perform these tasks:

- Carefully attach the handle to the unit.
- Attach RED battery wire to battery.
- Assemble hose reel to handle.
- Attach detergent hose clip to handle.
- Add oil to the engine crankcase.
- Add fuel to the fuel tank.
- Connect the high pressure hose to the spray gun and the pump.
- Connect the water supply to the pump.

Attach Handle to Pressure Washer

Carefully attach handle to unit as follows:

- Slowly tip the pressure washer forward and let it gently rest on its front bumper, as shown in Figure 1.

Figure 1 — Attach Handle to Pressure Washer

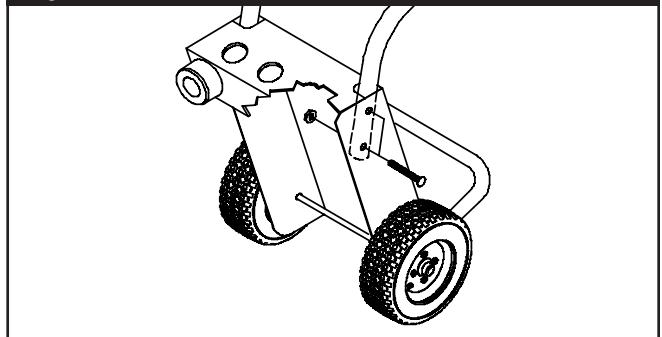

- Slowly insert the handle through the holes in the base, being careful to avoid touching the wires and other electrical components.
- Align the holes on the handle with the holes on the base.
- Insert the carriage bolts to hold the handle in place.

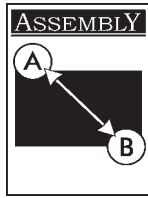

- Secure handle to the base using the four flange nuts. Tighten the flange nuts with a 13mm wrench. Use caution when tightening to avoid contact with wires and other electrical components.
- Attach the RED wire to the POSITIVE battery terminal (see Figure 2) by aligning the yellow connector with the terminal and pressing on firmly.

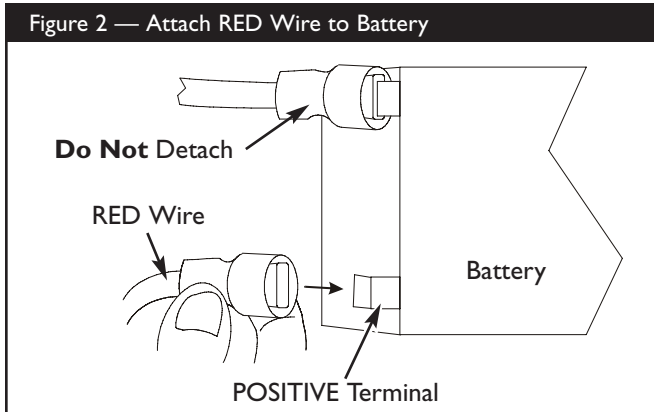

- Slowly tip the pressure washer back in place and insert the multi-colored nozzles in the spaces provided in the handle.
- From the rear of the unit, attach siphoning tube clip onto the right side of the handle with the self tapping screw. Position the self tapping screw into the pre-drilled hole just underneath the nozzle holder frame.
- Insert the detergent siphoning tube into the clip you just installed (Figure 3).

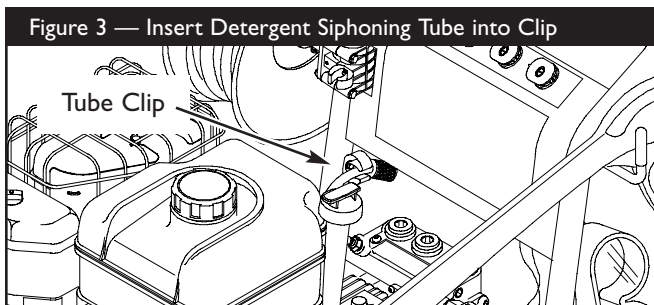

NOTE: When originally installed, this spring clip may be rather stiff. Stretch the clip opening several times before use so that the siphon filter can be more easily stored.

Assembling Hose Reel

IMPORTANT: You must take the hose off the reel when operating your high pressure washer. The reel is for hose storage purposes only.

- As shown in Figure 4, attach the handle to the reel with locknuts, flat washers, and bolts. Please note that the bolts are inserted with their heads inside the hose reel.

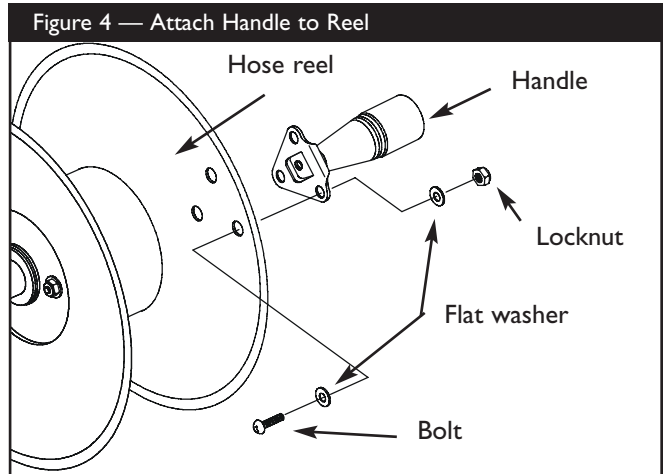

- As shown in Figure 5 (viewed from the front of the unit), secure the hose reel to the handle with locknuts, clamps, and bolts.

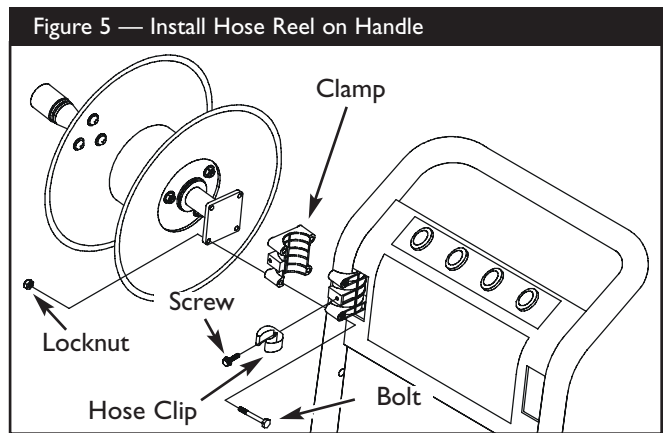

- Attach the spring clip with a black self tapping screw in the hole provided on the clamp.

NOTE: There may be some hardware included with the hose reel kit that is not used on this model.

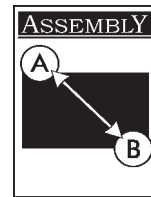

Add Engine Oil

IMPORTANT: Any attempt to crank or start the engine before it has been properly serviced with the recommended oil may result in an engine failure.

- Place pressure washer on a level surface.
- Refer to the engine owners manual to add recommended oil to engine.

NOTE: Check oil often during engine break-in. Refer to engine owner's manual for recommendations.

NOTE: The pump is pre-lubricated and sealed, requiring no additional lubrication for the life of the pump.

Add Gasoline

DANGER! Never fill fuel tank indoors. Never fill fuel tank when engine is running or hot. Do Not smoke when filling fuel tank.

WARNING! Never fill fuel tank completely full. Provide space for fuel expansion. Wipe away any fuel spillage from engine and equipment before starting.

- Use clean regular unleaded fuel and store in approved clean covered containers. Use clean fill funnels. Never use "stale" gasoline left over from last season or gasoline stored for long periods.
- Clean the area around the fuel fill cap, and remove the cap. Slowly fill tank to about 1/2" below the bottom of the filler neck (Figure 6).

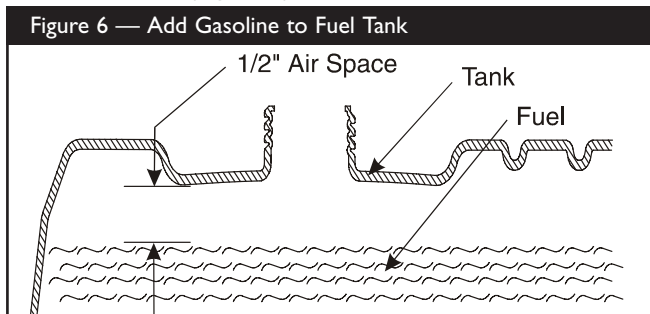

- Install the fuel cap and wipe up any spilled gasoline.

Connect Hose and Water Supply to Pump

IMPORTANT: You must assemble the nozzle extension to the spray gun and attach all hoses before you start the engine. Starting engine without all hoses connected and water supplied will damage the pump.

- Uncoil high pressure hose and attach quick connect end of hose to the base of the spray gun (Figure 7). Pull down on the collar of the quick connect, slide onto the spray gun and let go of collar. Tug on hose to be sure of a tight connection.

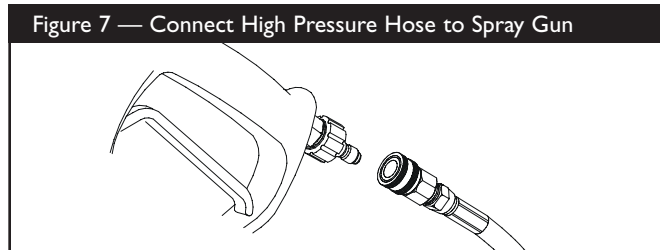

- Attach the other end of the high pressure hose to the high pressure outlet on the pump (Figure 8). Pull down on the collar of the quick connect, slide onto the pump and let go of collar. Pull on hose to be sure of a tight connection.

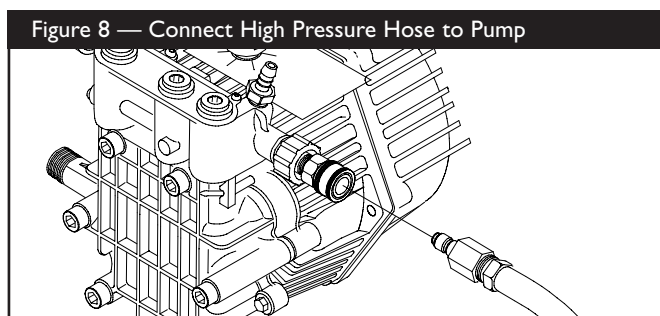

- Before you connect your garden hose to the water inlet, inspect the inlet screen (Figure 9). Clean the screen if it contains debris; replace it if it is damaged. DO NOT RUN THE PRESSURE WASHER IF THE SCREEN IS DAMAGED OR MISSING.

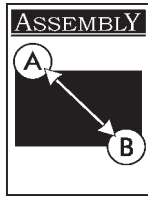

- Run water through your garden hose for 30 seconds to clean out any debris. Turn off water.
- Connect the garden hose to the water inlet. Tighten by hand (Figure 9).

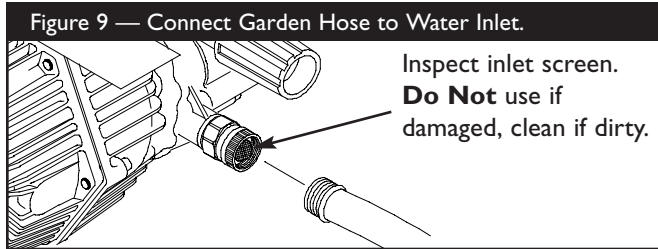

WARNING! There MUST be at least ten feet of unrestricted garden hose between the pressure washer inlet and any flow shut off device, such as a 'Y' shut-off connector or other convenience-type water shut-off valve. Damage to pressure washer resulting from disregarding this warning will not be covered by the warranty.

- Turn ON the water and squeeze the trigger on the spray gun to purge the pump system of air and impurities.
- Attach the nozzle extension to the spray gun. Tighten by hand (Figure 10).

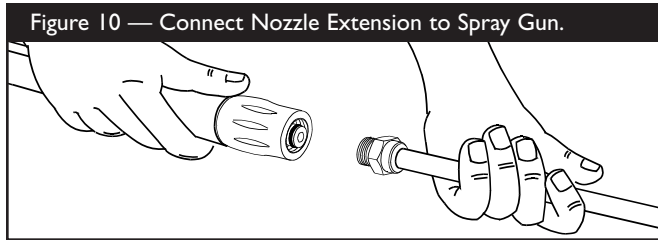

CHECKLIST BEFORE STARTING ENGINE

Review the unit's assembly to confirm you have performed all of the following:

- Make sure the handle is in place and secure.
- Make sure the RED battery wire is connected.
- Check that all hose reel fasteners are tight.
- Check for properly tightened hose connections.
- Check to make sure that there are no kinks, cuts, or damage to the high pressure hose.
- Check that oil has been added to the proper level in the engine crankcase.
- Add the proper gasoline to fuel tank.
- Provide a proper water supply (not to exceed 140°F) at an adequate flow.
- Be sure to read "Safety Rules" and "Preparing Pressure Washer For Use" before using the pressure washer.



HOW TO USE YOUR PRESSURE WASHER

If you have any problems operating your pressure washer, for assistance call the pressure washer helpline at **1-800-270-1408**.

How to Start Your Engine

The best way to start your pressure washer for the first time is to follow these instructions step-by-step. You may also refer to your engine owner's manual. This information also applies after you have let the pressure washer sit idle for at least a day.

CAUTION: Before starting the pressure washer, be sure you are wearing adequate eye protection.

- Place the pressure washer in an area close enough to an outside water source capable of supplying water at a flow rate greater than 3.3 gallons per minute.
- Check that the high pressure hose is connected to the spray gun and to the pump. See "Preparing Pressure Washer for Use" for illustrations.
- Make sure unit is in a level position.

- Connect the garden hose to the water inlet on the pressure washer pump. **Turn on the water.**

CAUTION: Do Not run the pump without the water supply connected. Failure to do so will cause damage the pump that is not warranted.

- Squeeze the trigger on the spray gun until you have a steady stream of water. This purges the pump of air and impurities.
- Attach the nozzle extension to the spray gun. Tighten by hand.
- Choose the nozzle you want to use and insert it into the nozzle extension. See "How to Use the Nozzles" on page 10.
- Engage the safety latch to the spray gun trigger (Figure 11).

Figure 11 — Spray Gun with Safety Latch Engaged

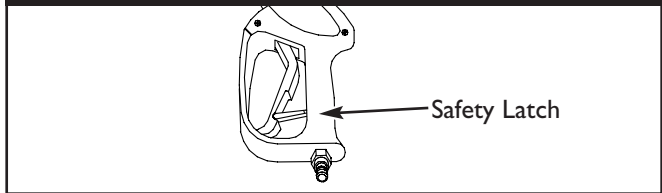

- Rotate the fuel shut-off valve to the "On" position (fully counter-clockwise).

NOTE: Engine controls are shown below in Figure 12.

Figure 12 - Engine Controls

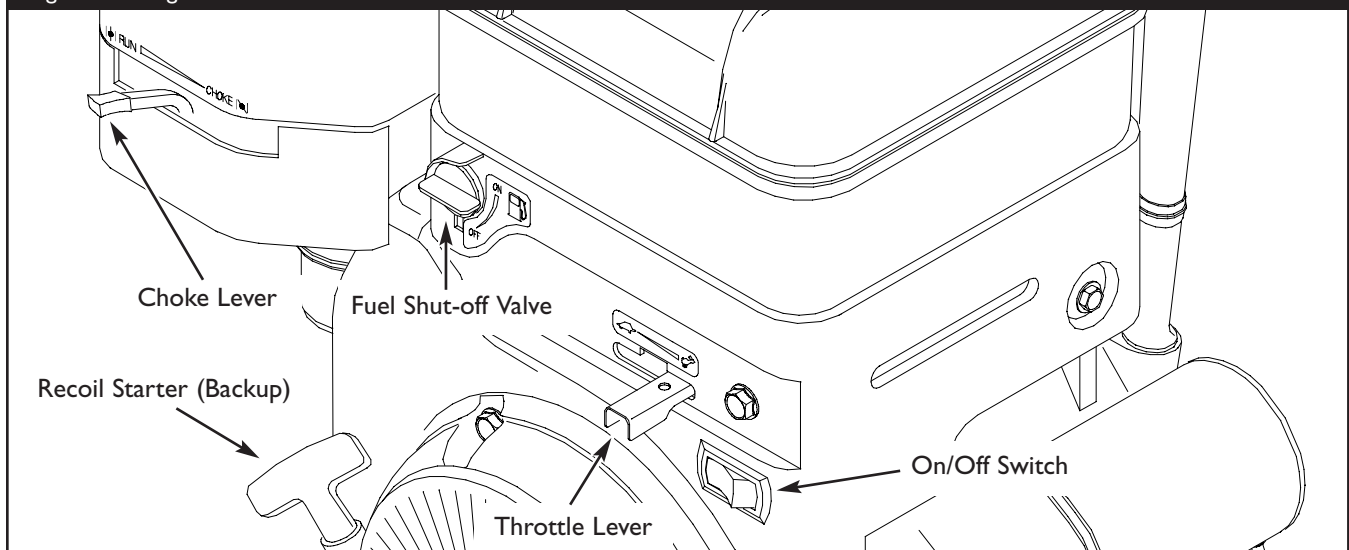



- Move throttle lever to “Fast” position, shown as a rabbit.
- Position the choke lever to the “Choke” position.

NOTE: For a warm engine, be sure the choke lever is in the “Run” position.

- Push the On/Off switch to the “On” position.
- For electric start, press push-button start switch until engine cranks and starts. Limit electric start cycles to 5 seconds of cranking per every 30 seconds to prolong life of starter.
- For manual start, pull slowly on recoil handle until you feel some resistance. Then pull rapidly to start engine. Return handle slowly. **Do Not** let it “snap back” against starter housing.
- If the choke was placed in the “Choke” position to start the engine, slowly push it to the “Run” position as the engine warms up enough to run smoothly.
- If the engine fails to start, review instructions given in the engine owner’s manual.

How to Stop Your Pressure Washer

- Move throttle lever to “Slow” position.
- Push on/off switch to the “Off” position.
- Turn the fuel shut-off valve to the “Off” position.
- Squeeze trigger on the spray gun to relieve pressure in the hose.

NOTE: A small amount of water will squirt out when you release the pressure.

Battery Safety

NOTE: Battery is a sealed lead acid battery.

! DANGER! If battery case cracks, **Do Not** permit smoking, open flame, sparks or any other source of heat around battery. Wear protective goggles, rubber apron and rubber gloves when working around battery. Battery electrolyte fluid is an extremely caustic sulfuric acid solution that can cause severe burns. If spill occurs, flush area with clear water immediately.

How to Use Battery Charger

Use battery charger jack with the provided battery charger to keep the starting battery charged and ready for use. Battery charging should be done in a dry location, such as inside a garage.

- Lift the flap to plug the charger into the unit’s “12V DC Battery Charger” jack. Plug battery charger into a 120 Volt AC wall receptacle.
- Unplug the charger from the unit and the wall outlet when pressure washer is being started and while it is in operation.
- Keep this charger plugged in when pressure washer is not in use to prolong battery life. The charger has a built in float equalizer and will not overcharge the battery, even when plugged in for an extended period of time.

IMPORTANT: See “Battery Maintenance” on page 15 for additional information.

How to Use the Nozzles

! DANGER! Never exchange nozzles without locking the safety latch on the spray gun.

The quick-connect on the nozzle extension allows you to switch between four different nozzles. The nozzles vary the spray pattern, as shown in Figure 13.

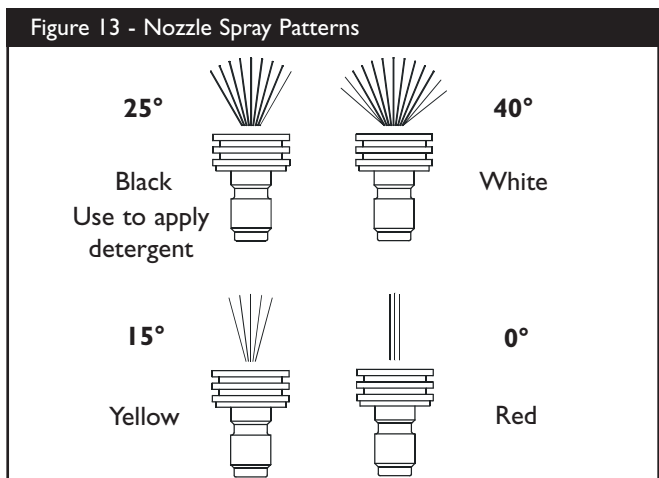

To change nozzles:

- Engage the safety latch on the spray gun.

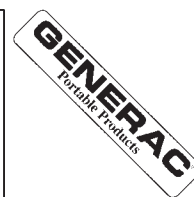

- Pull back the collar on the quick-connect and pull the current nozzle off. Store the nozzle in the space provided on the control panel.

NOTE: For a more gentle rinse, select white 40° nozzle. To scour the surface, select yellow 15° or red 0° nozzle. To apply detergent, select black nozzle.

- Pull back on the collar, insert the new nozzle and release the collar. Pull on the nozzle to make sure it is securely in place.
- Located on the pump is a pressure control knob (Figure 14). You can increase (decrease) the pressure of the spray by turning the knob clockwise (counterclockwise).

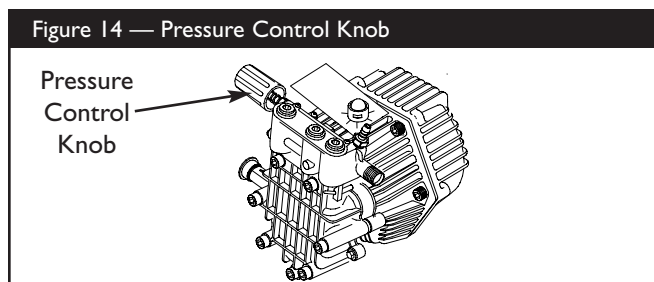

- For most effective cleaning, keep the spray nozzle between 8 to 24 inches away from the cleaning surface. If you get the spray nozzle too close, you may damage the cleaning surface.

Cleaning and Applying Chemical

WARNING! You must attach all hoses before you start the engine. Starting the engine without all the hoses connected and without the water turned ON will damage the pump.

IMPORTANT: Use soaps designed specifically for pressure washers. Household detergents could damage the pump.

To apply detergent follow these steps:

- Review the use of the nozzles.
- Prepare detergent solution as required by the job.
- Hang the detergent solution container on the hook at the rear of the pressure washer.
- Place the small filter of the detergent injection tube into the detergent container.



CAUTION! Keep the detergent siphon tube from coming in contact with the hot muffler. This will damage the detergent injection tube. When inserting the filter into a detergent bottle, route the tube so as to keep it from inadvertently contacting the hot muffler.

- Make sure the black nozzle is installed on the nozzle extension.

NOTE: Detergent cannot be applied with the high pressure nozzles (White, Yellow, or Red).

- Make sure the garden hose is connected to the water inlet. Check that high pressure hose is connected to spray gun and pump, then start engine.
- Apply the detergent to a dry surface, starting at lower portion of area to be washed and work upward, using long, even, overlapping strokes. **Do Not** allow the detergent to dry on. Allowing detergent to dry on surface may cause streaking.
- Allow the detergent to soak between 3–5 minutes before washing and rinsing. Reapply as needed to prevent surface from drying.

Pressure Washer Rinsing



WARNING! Be extremely careful if you must use the pressure washer from a ladder, scaffolding or any other relatively unstable location. Pressure in a running washer builds as you climb. When you press the trigger, the recoil from the initial spray could cause you to fall. The high pressure spray could also cause you to fall if you are too close to the cleaning surface.

After you have applied detergent, scour the surface and rinse it clean as follows:

- Apply safety latch to spray gun.
- Remove the black nozzle from the nozzle extension.
- Select and install the desired high pressure nozzle, as described in “How to Use the Nozzles”.
- Keep the spray gun a safe distance from the area you plan to spray.
- Disengage the safety latch on the spray gun.



- Apply a high pressure spray to a small area and then check the surface for damage. If no damage is found, you can assume it is okay to continue cleaning.
- Start at the top of the area to be rinsed, working down with same overlapping strokes used for cleaning.
- The use of a brush may be helpful on some hard to clean surfaces.

Automatic Cool Down System (Thermal Relief)

If you run the engine on your pressure washer for 3-5 minutes without pressing the trigger on the spray gun, circulating water in the pump can reach a temperature between 140–145°F. **When the water reaches this temperature, the automatic cool down system engages and cools the pump by discharging the warm water onto the ground. This system prevents internal damage to the pump.** Once the pump has cooled, it will stop discharging.

NOTE: This discharge is not a leak. **Do Not** return the pressure washer for this reason.

How to Use the Hose Reel

Your pressure washer is equipped with a hose reel that is designed to store your hose when the unit is not in use.

After each use:

- Disconnect hose from spray gun and high pressure outlet on pump.
- Drain water from hose.

High Pressure Hose Storage

The factory-recommended way to store the high pressure hose is to roll it onto the reel in a counter-clockwise manner, as follows:

- Insert the male end of the hose through the hole in the hose reel hub, as shown in Figure 15.

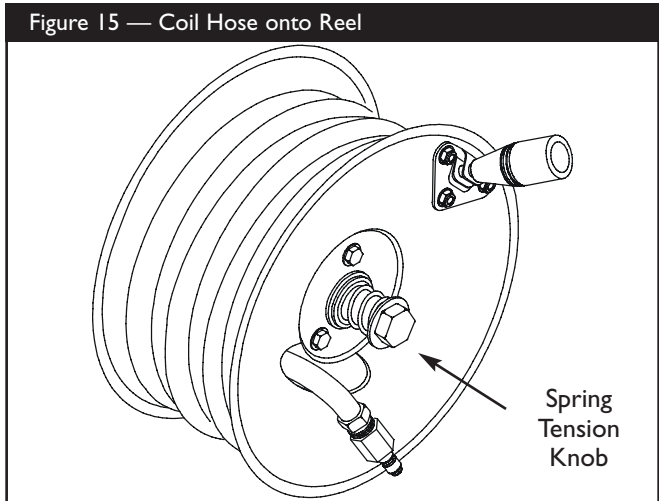

- While guiding the hose with your left hand, grasp the hose reel handle and turn the reel counter-clockwise. Apply sufficient tension on the hose to force it to coil tightly against the hose reel hub.
- When the entire hose has been reeled, the loose hose end is clipped into the hose clip, as shown in Figure 16.

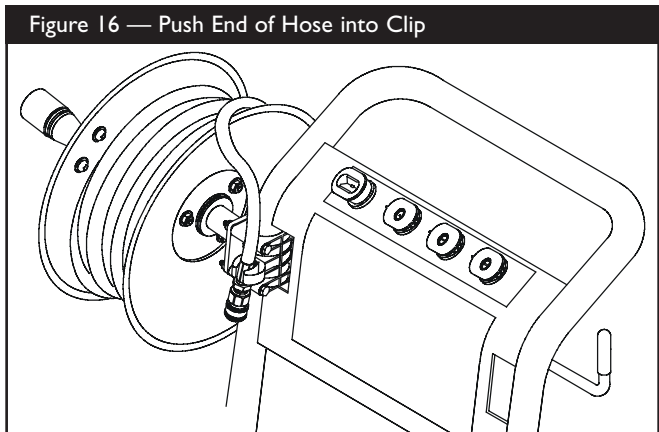

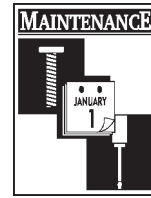

Adjustable Hose Reel Spring Tension

The hose reel is provided with a spring tension adjustment knob (Figure 15).

Although the operator can loosen or tighten the knob to achieve the desired reel tension, the factory recommends that the knob be fully hand tightened (clockwise).

REMEMBER: Do Not use your pressure washer with the hose coiled onto the hose reel. The hose reel is for hose storage only.

SPECIFICATIONS

Outlet Pressure 2,500 psi

Flow Rate 3.0 gallons per minute (gpm)

Detergent Use detergent approved for pressure washers

Water Supply Temperature Not to Exceed 140°F

Automatic Cool Down System Will cycle when water reaches 140°-145°F

GENERAL MAINTENANCE RECOMMENDATIONS

The pressure washer warranty does not cover items that have been subjected to operator abuse or negligence. To receive full value from the warranty, the operator must maintain the pressure washer as instructed in this manual.

- Some adjustments will need to be made periodically to properly maintain your pressure washer.
- All adjustments in the Maintenance section of this manual should be made at least once each season.
- Once a year you should clean or replace the spark plug and clean or replace the air filter and check the spray gun and nozzle extension for wear. A new spark plug and clean air filter assure proper fuel-air mixture and help your engine run better and last longer.

Before Each Use

- Unplug battery charger from unit.
- Check engine oil level.
- Check water inlet screen for damage.
- Check high pressure hose for leaks.
- Remove hose completely from reel before spraying.
- Check detergent siphon tube and filter for damage.
- Check spray gun and nozzle extension assembly for leaks.
- Rinse out garden hose to flush out debris.

PRESSURE WASHER MAINTENANCE

Check and Clean Inlet Screen

Examine the screen on the water inlet. Clean it if the screen is clogged or replace it if screen is damaged.

Check High Pressure Hose

The high pressure hose can develop leaks from wear, kinking, or abuse. Inspect the hose each time before using it. Check for cuts, leaks, abrasions or bulging of cover, damage or movement of couplings. If any of these conditions exist, replace the hose immediately.

 **DANGER!** Water spraying from a leak is capable of injecting material into skin. Inspect hose each time before using it. **Never** repair a high pressure hose. Replace it with another hose that exceeds the maximum pressure rating of your pressure washer.

Check Chemical Injection Tube

Examine the filter on the detergent hose and clean if clogged. The tube should fit tightly on the pump's barbed fitting. Examine the tube for leaks or tears. Replace the filter or tube if either is damaged.

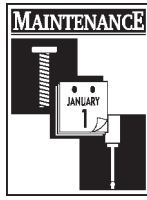

Check In-Line Filter

Refer to Figure 17 and service the in-line filter if it becomes clogged, as follows:

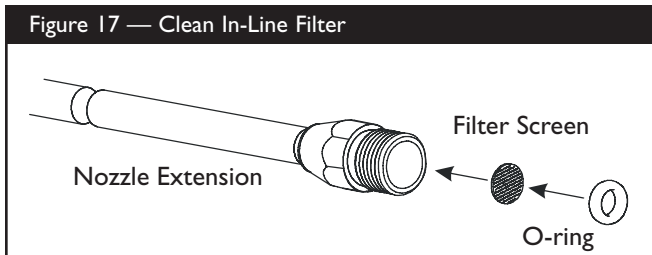

1. Detach spray gun and nozzle extension from high pressure hose. Detach nozzle extension from spray gun and remove o-ring and screen from nozzle extension. Flush the screen, spray gun, and nozzle extension with clean water to clear debris.
2. If the screen is damaged, the o-ring kit contains a replacement in-line filter screen and an o-ring. If undamaged, reuse screen.
3. Place the in-line filter screen into the threaded end of the nozzle extension. Direction does not matter. Push the screen in with the eraser end of a pencil until it rests flat at the bottom of the opening. Take care to not bend the screen.
4. Place the o-ring into the recess. Push the o-ring snugly against the in-line filter screen.
5. Assemble the nozzle extension to the spray gun, as described earlier in this manual.

Check Spray Gun and Nozzle Extension

Examine the hose connection to the spray gun and make sure it is secure. Test the trigger by pressing it and making sure it springs back into place when you release it. Put the safety latch in the ON position and test the trigger. You should not be able to press the trigger.

Purge Pump of Air and Contaminants

To remove air from the pump, follow these steps:

- Set up the pressure washer as described in “Preparing the Pressure Washer for Use” and connect the water supply. Turn ON the water.
- Pull the trigger on the spray gun and hold.
- When the water supply is steady and constant, engage the safety latch.

To remove contaminants from the pump, follow these steps:

- Set up the pressure washer as described in “Preparing the Pressure Washer for Use” and connect the water supply.
- Remove the nozzle extension from the spray gun.
- Start the engine according to instructions given in “How To Use Your Pressure Washer”.
- Squeeze the trigger on the spray gun and hold.
- When the water supply is steady and constant, engage the safety latch and refasten the nozzle extension.

Detergent Siphon Tube

If you have used the detergent siphon tube you must flush it with clean water before storing the unit.

- Place the detergent siphon tube in a bucket full of clean water.
- With the engine running, flush for 1–2 minutes.
- Shut off the engine.

IMPORTANT: Simply shutting OFF engine will not release pressure in the system. When the engine has shut down, **squeeze the trigger on the spray gun to relieve the pressure in the hose.**

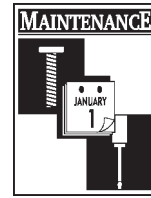

Nozzle Maintenance

If the nozzles becomes restricted or clogged with foreign materials, such as dirt, excessive pump pressure may develop. If the nozzles become partially clogged, it can cause a pulsing sensation during use. This generally is not a pump related problem, but rather a clogged or partially restricted nozzle.

If the nozzles become clogged or partially restricted, immediately clean the nozzles with the kit included with your pressure washer by following these instructions:

- Shut off the engine and turn off the water supply.
- Remove the nozzle from the end of the nozzle extension.
- Use the wire included in the kit or a small paper clip to free the foreign materials clogging or restricting the nozzle (Figure 18).

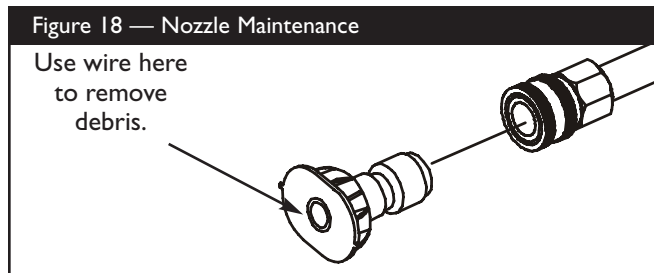

- Remove additional debris by rinsing out the nozzle for 30 to 60 seconds.
- Reinstall the nozzle into the nozzle extension.
- Reconnect the water supply, turn on the water, and start the engine.
- Test the pressure washer.

O-Ring Maintenance

Through the normal operation of your pressure washer, o-rings, which keep the connections of the hoses and spray gun tight and leak-free, may become worn or damaged.

Provided with your pressure washer is an O-Ring Maintenance Kit which includes replacement o-rings, a rubber washer and a water inlet filter. Refer to the instruction sheet provided in the kit to service your unit's o-rings. Note that not all of the parts in the kit will be used on your unit.

To remove a worn or damaged o-ring:

- Use a small flathead screwdriver to get underneath the o-ring and pry it off.

Battery Maintenance

This unit is supplied with battery and charger jack connections covered with insulating compound to avoid corrosion and prolong battery life.

Some dielectric compound may squirt out when plugging the charger into the jack for the first time. Add more compound (Generac part number 185928 or GC Electronics number 10-8101 or equivalent) only if the connections are no longer coated with dielectric compound.

NOTE: Do Not use petroleum jelly in the absence of dielectric compound.

Other than trickle charging, described elsewhere, no maintenance is required for the battery. If you have a need to contact the battery manufacturer, call 888-841-5179.

IMPORTANT: Battery charging should be performed in a dry location, such as inside a garage.

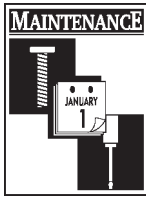

ENGINE MAINTENANCE

See the engine owner's manual for instructions on how to properly maintain the engine.

PREPARING THE UNIT FOR STORAGE

Water should not remain in the unit for long periods of time. Sediments or minerals can deposit on pump parts and "freeze" pump action. If you do not plan to use the pressure washer for more than 30 days, follow this procedure:

1. Flush detergent siphoning tube by placing the filter into a pail of clean water while running pressure washer in low pressure mode. Flush for one to two minutes.
2. Shut off the engine and let it cool, then remove all hoses. Disconnect spark plug wire from spark plug.
3. Empty the pump of all pumped liquids by pulling the recoil handle about 6 times. This should remove most of the liquid in the pump.

NOTE: To protect the unit from freezing temperatures, draw RV antifreeze (non-alcohol) into the pump by pouring the solution into a 3-foot section of garden hose connected to inlet adapter and pulling recoil handle twice.

4. Store unit in a clean, dry area.

Hose Storage:

- Disconnect hose from spray gun and high pressure outlet on pump. Drain water from hose and wipe off the hose with a rag.
- Store the hose on the hose reel as described in "How To Use the Hose Reel".

Battery Storage:

Store your unit with the DC battery charger plugged in to keep your battery charged and ready for use.

If you store your pressure washer below freezing temperatures and the charger cannot be plugged in, charge the battery for 24 hours prior to storage. Be sure to recharge the battery once each month to maintain a fully charged battery.

STORING THE ENGINE

See the engine owner's manual for instructions on how to properly prepare the engine for storage.



TROUBLESHOOTING

Problem	Cause	Correction
Pump has following problems: failure to produce pressure, erratic pressure, chattering, loss of pressure, low water volume.	<ol style="list-style-type: none"> 1. Low pressure nozzle (black) is being used. 2. Water inlet is blocked. 3. Inadequate water supply. 4. Inlet hose is kinked or leaking. 5. Clogged inlet hose strainer. 6. Water supply is over 140°F. 7. High pressure hose is blocked or leaks. 8. Gun leaks. 9. Nozzle is obstructed. 10. Pump is faulty. 	<ol style="list-style-type: none"> 1. Replace with any of the three high pressure nozzles. 2. Clear inlet. 3. Provide adequate water flow. 4. Straighten if kinked or replace hose. 5. Check and clean inlet hose strainer. 6. Provide cooler water supply. 7. Clear blocks in outlet hose or replace if leaking. 8. Replace gun. 9. Clean nozzle. 10. Contact Generac service facility.
Detergent fails to mix with spray.	<ol style="list-style-type: none"> 1. Detergent siphoning tube is not submerged. 2. Chemical filter is clogged. 3. A high pressure nozzle is being used. 	<ol style="list-style-type: none"> 1. Insert detergent siphoning tube into detergent. 2. Clean or replace filter/detergent siphoning tube. 3. Replace with low pressure (black) nozzle.
Engine runs good at no-load but “bogs” when load is added.	Engine speed is too slow.	Move throttle control to FAST position. If engine still “bogs down”, contact Briggs and Stratton service facility.
Engine will not start; or starts and runs rough.	<ol style="list-style-type: none"> 1. Dirty air cleaner. 2. Out of gasoline. 3. Stale gasoline. 4. Spark plug wire not connected to spark plug. 5. Bad spark plug. 6. Water in gasoline. 7. Overchoking. 8. White smoke from exhaust. 9. Intake valve stuck open or closed. 10. Engine has lost compression. 11. Battery dead. 	<ol style="list-style-type: none"> 1. Clean or replace air cleaner. 2. Fill fuel tank. 3. Drain gas tank; fill with fresh fuel. 4. Connect wire to spark plug. 5. Replace spark plug. 6. Drain gas tank; fill with fresh fuel. 7. Open choke fully and crank engine. 8. Contact Briggs and Stratton service facility. 9. Contact Briggs and Stratton service facility. 10. Contact Briggs and Stratton service facility. 11. Charge or replace battery. See phone number on battery.
Engine shuts down during operation.	Out of gasoline.	Fill fuel tank.
Engine lacks power.	Dirty air filter.	Replace air filter.
Engine “hunts” or falters.	Choke is opened too soon.	Move choke to halfway position until engine runs smoothly.

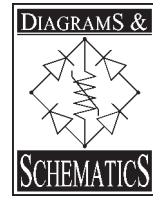

SCHEMATIC AND WIRING DIAGRAM

12 VDC FLOAT
CHARGER INPUT

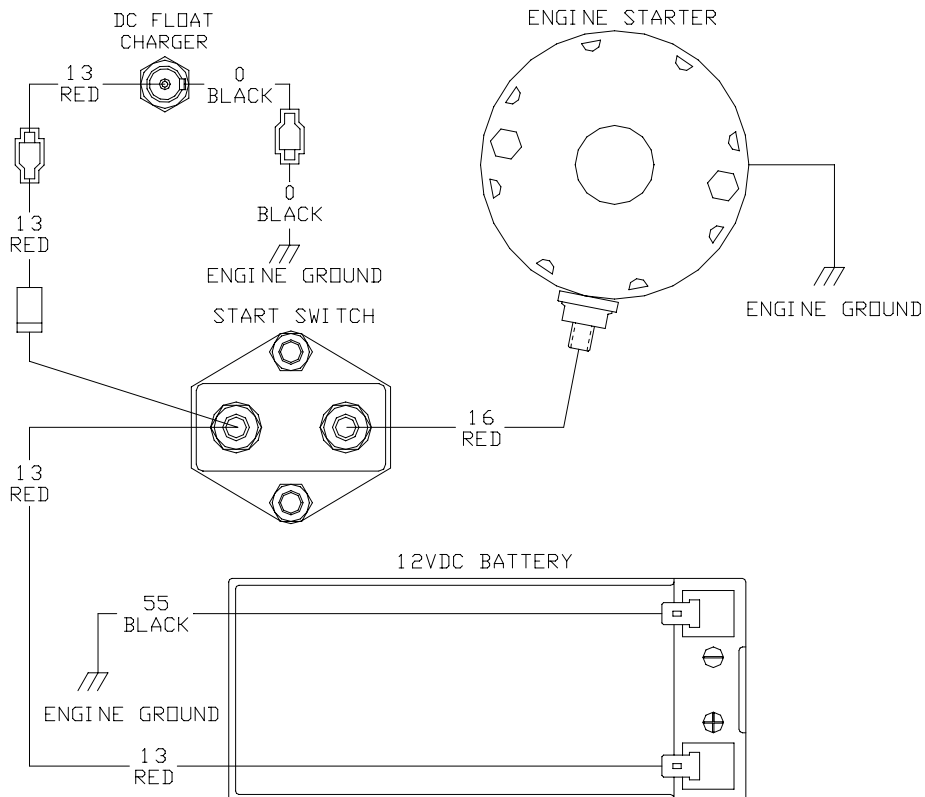
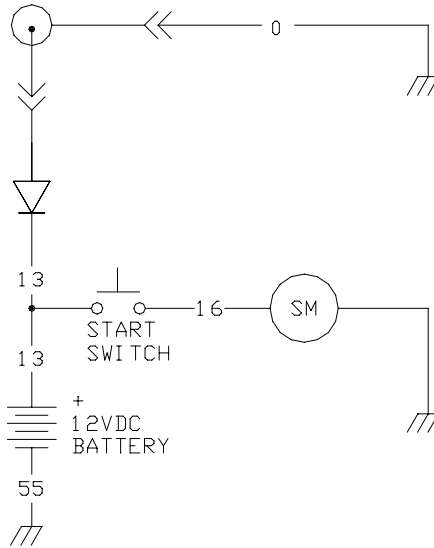

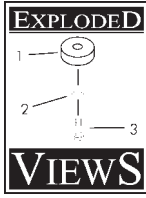

EXPLODED VIEW — UNIT

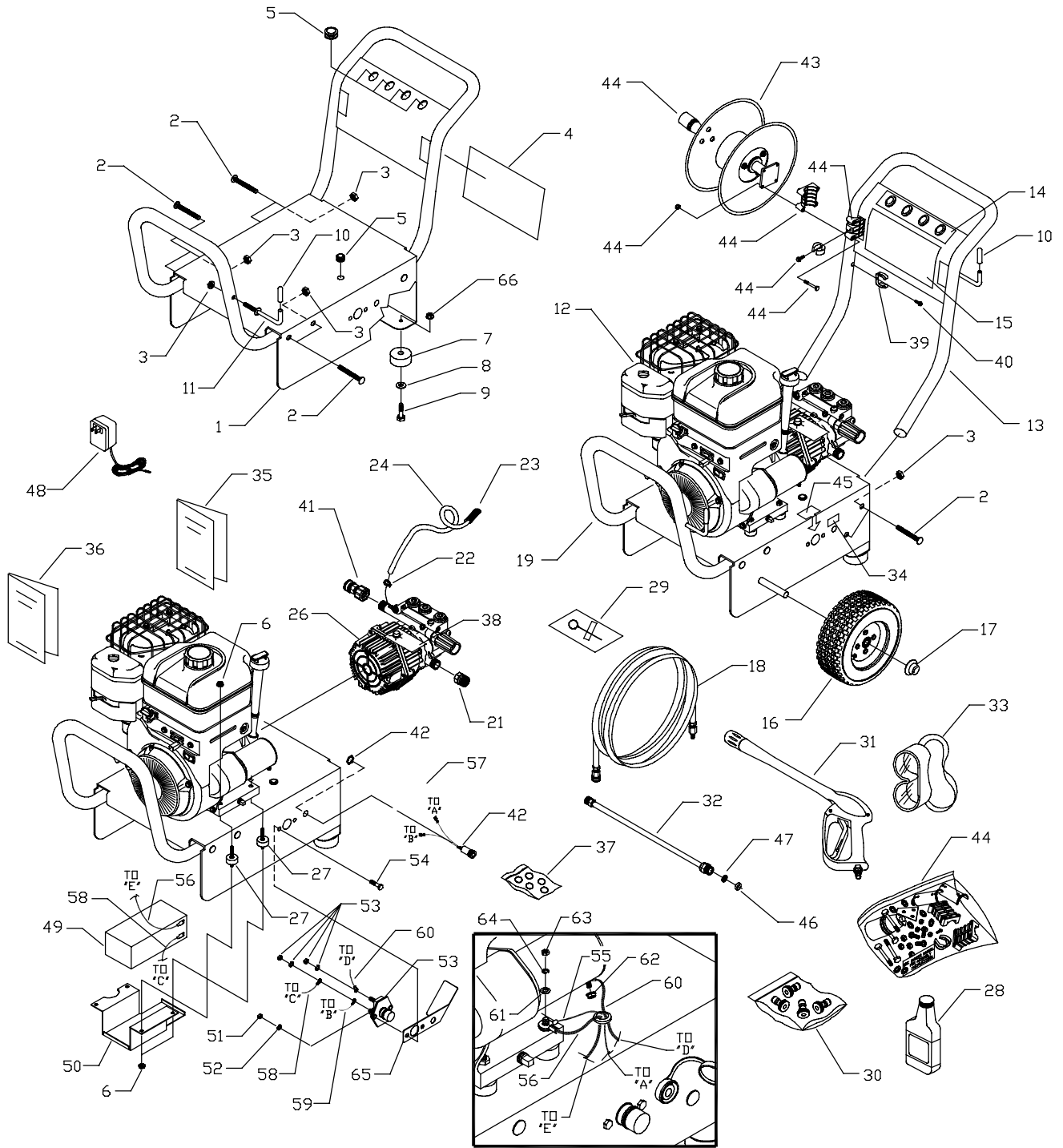

Detail of Electrical Hookup

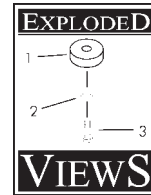

PARTS LIST — UNIT

Item	Part #	Qty.	Description	Item	Part #	Qty.	Description
1	AB5721A	1	BASE	34	186050	1	DECAL, Battery Charge
2	B2043	8	BOLT, 5/16" - 18 x 1-3/4" Carriage	35	B5786	1	MANUAL, Owners
3	99583	9	NUT, Hex Flange 5/16" - 18	36	B3297	1	MANUAL, Engine
4	185929	1	DECAL, Instructions	37	B5830	1	KIT, O-Ring Maintenance
5	30809	5	GROMMET, 1/8" - 11/16"	38	B1288	1	TAG, PW Breather Cap
6	67989	8	NUT, M8 Flange Serr.	39	65852A	1	SPRING CLIP, Holder
7	27007	2	VIB MOUNT, Donut Type	40	185954	1	SCREW, Self Tap #8-18 x 1/2"
8	50190	2	FLAT WASHER, 10GA - .34" x 1"	41	185923	1	QUICK CONNECT, M22
9	42909	2	HHCS, M8 - 1.25 x 30	42	186166	1	ASSY., Jack Coaxial DC
10	B2516	3	CAP, Black Vinyl .280"	43	186114	1	REEL, Hose
11	B2150	1	HOOK, 5/16" Square Neck Gun	44	186113	1	KIT, Hardware Hose Reel
12	NSP	1	ENGINE, B&S Intek Pro 6.5HP	45	B5826	1	DECAL, Push Button Start
13	CB5779	1	HANDLE	46	97837	1	O-RING, High Pressure Trans.
14	B4163	1	DECAL, 4 QD Nozzles	47	B4224	1	SCREEN, Gun Inlet
15	B5782	1	DECAL, Unit	48	B4177	1	CHARGER, Battery
16	B4966	2	ASSEMBLY, 10" Wheel & Tire	49	NSP	1	BATTERY, 12V
17	75402C	2	PUSHNUT, 5/8"	50	B5835	1	TRAY, Battery
18	B5694	1	HOSE, 5/16" x 25'	51	22127	2	NUT, 1/4" - 20
19	CB3866	1	BUMPER	52	22097	2	LOCKWASHER, 1/4" - M6
21	21424	1	CONNECTOR, Garden Hose	53	77282	1	SWITCH, Starter
22	48031G	1	CLAMP, Hose 7/16" Dia.	54	22413	2	HHCS, 1/4" - 20 x 1"
23	A1041	1	FILTER, Chemical Hose	55	185973A	1	WIRE, #0
24	A1040D	1	HOSE, 5/4" Chemical Inject	56	185931B	1	WIRE, #55
26	B4148	1	ASSY, Pump (See pages 22-23)	57	186133	1	COVER, DC Jack
27	21217	4	MOUNT, Rubber Shock	58	185931A	1	WIRE, #13
28	BB3061B	1	OIL BOTTLE	59	186748	1	WIRE, Diode, #13
29	B2509	1	KIT, Nozzle Cleaning	60	185939A	1	WIRE, #16
30	186179	1	KIT, Nozzles QD	61	22145	1	WASHER, Flat M8
31	B3263A	1	SPRAY GUN, 3200PSI M22-1.5	62	B2071	1	NUT, 1/4" - 20 Flange Lock
32	B3858	1	ASSY., Wand Ext. with QD	63	45771	1	NUT, Hex M8 - 1.25
33	87815	1	GOGGLES, Safety	64	22129	1	LOCK WASHER, M8
				65	A186750	1	BRACKET, Starter Guard
				66	52858	2	NUT, Locking M8 - 1.25

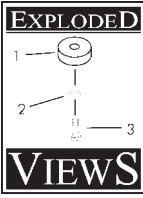

EXPLODED VIEW — PUMP

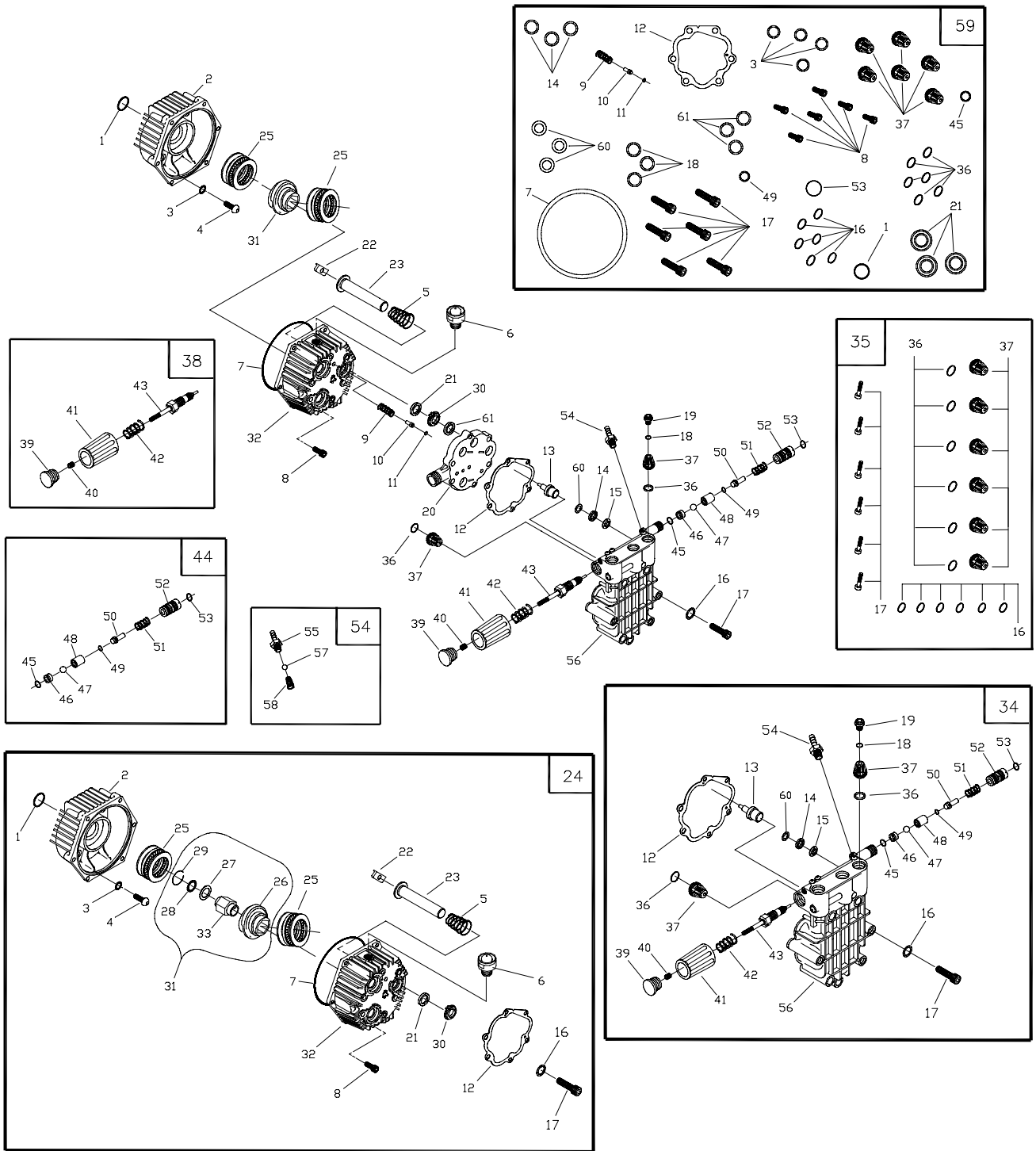

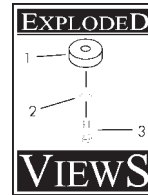

PARTS LIST — PUMP

Item	Part #	Qty.	Description
1	B2218	1	O-RING, Engine Adapter
2	B2260	1	ADAPTER, Housing, Cam
3	B2217	4	O-RING, Engine Adapter Bolt
4	B2261B	4	SCREW, Button Hd 5/16 - 24 x 3/4"
5	96400	3	SPRING, Piston Return
6	99735	1	ASSEMBLY, Oil Breather
7	93790	1	O-RING, Crankcase
8	40945	6	SHCS, M6 x 1.0 x 20mm
9	93652	1	SPRING, Thermal By-Pass
10	95416	1	PISTON, Thermal By-Pass
11	93876	1	O-RING, Thermal By-Pass
12	A2069	1	GASKET, Head
13	93644	1	ACTUATOR, Thermal By-Pass
14	96053	3	SEAL, High Pressure
15	96015	3	RING, Bearing
16	B2665	6	WASHER, Steel Special
17	A2013	6	BOLT, Head M8 x 1.25 x 70mm
18	97840	3	O-RING, Cap
19	97841	3	CAP, Outlet Port
20	A1320	1	SPACER PLATE, Inlet
21	93680	3	SEAL, Oil Piston
22	94944	3	SHOE, Piston Pivot
23	99427	3	ASSEMBLY, Ceramic Piston & Cap
24	185948	0	KIT, Crankcase
1	1	O-RING, Engine Adapter
2	1	ADAPTER, Housing, Cam
3	4	O-RING, Engine Adapter Bolt
4	4	SCREW, Button Hd 5/16 - 24 x 3/4"
5	3	SPRING, Piston Return
6	1	ASSEMBLY, Oil Breather
7	1	O-RING, Crankcase
8	6	SHCS, M6 x 1.0 x 20mm
12	1	GASKET, Head
16	6	WASHER, Steel Special
17	6	BOLT, Head M8 x 1.25 x 70mm
21	3	SEAL, Oil Piston
22	3	SHOE, Piston Pivot
23	3	ASSEMBLY, Ceramic Piston & Cap
25	2	BEARING SET, Thrust 15.5
30	3	SPACER, Pilot
31	1	ASSEMBLY, Cam
26	1	CAM, Axial 6.0 Lift
27	1	WASHER, Thrust
28	1	RETAINER, Push - On
29	1	C-RING, Cam Retainer
33	1	ADAPTER, Shaft Hex
32	1	HOUSING, Piston
34	185752	0	KIT, Complete Head
12	1	GASKET, Head
13	1	ACTUATOR, Thermal By-Pass
14	3	SEAL, High Pressure
15	3	RING, Bearing
16	6	WASHER, Steel Special
17	6	BOLT, Head M8 x 1.25 x 70mm
18	3	O-RING, Cap
19	3	CAP, Outlet Port
36	6	O-RING, Check Valve
37	6	ASSEMBLY, Check Valve
39	1	CAP, Plastic
40	1	SET SCREW, M6 x 8
41	1	HANDLE, Unloader
42	1	SPRING, Unloader

Item	Part #	Qty.	Description
43	1	ASSEMBLY, Spindle
45	1	O-RING, Spindle
46	1	SEAT, Ball Unloader
47	1	BALL, Stainless Steel 9/32 Dia.
48	1	SEAT, Trapped Line Pressure
49	1	O-RING, Trapped Line Pressure
50	1	VALVE, Shuttle Piston
51	1	SPRING, Piston Trapped Pressure
52	1	VENTURI, Chemical
53	1	O-RING, Venturi
56	1	ASSEMBLY, Head, Brass
60	3	SPACER, High Pressure Seal
35	185933	0	KIT, Check Valve
16	6	WASHER, Steel Special
17	6	BOLT, Head M8 x 1.25 x 70mm
36	6	O-RING, Check Valve
37	6	ASSEMBLY, Check Valve
38	B3479	0	KIT, Unloader Spindle
39	1	CAP, Plastic
40	1	SET SCREW, M6 x 8
41	1	HANDLE, Unloader
42	1	SPRING, Unloader
43	1	ASSEMBLY, Spindle
44	B3510	0	KIT, High Pressure Outlet
45	1	O-RING, Spindle
46	1	SEAT, Ball Unloader
47	1	BALL, Stainless Steel 9/32 Dia.
48	1	SEAT, Trapped Line Pressure
49	1	O-RING, Trapped Line Pressure
50	1	VALVE, Shuttle Piston
51	1	SPRING, Piston Trapped Pressure
52	1	VENTURI, Chemical
53	1	O-RING, Venturi
54	185943	0	KIT, Chemical Injector
55	1	BARB HOSE, Brass with Nylon Insert
57	1	BALL, 5.5 dia. Chemical Injector
58	1	SPRING, Chemical Injector
59	185926	0	KIT, O-Ring Seals
1	1	O-RING, Engine Adapter
3	4	O-RING, Engine Adapter Bolt
7	1	O-RING, Crankcase
8	6	SHCS, M6 x 1.0 x 20mm
9	1	SPRING, Thermal By-Pass
10	1	PISTON, Thermal By-Pass
11	1	O-RING, Thermal By-Pass
12	1	GASKET, Head
14	3	SEAL, High Pressure
16	6	WASHER, Steel Special
17	6	BOLT, Head M8 x 1.25 x 70mm
18	3	O-RING, Cap
21	3	SEAL, Oil Piston
36	6	O-RING, Check Valve
37	6	ASSEMBLY, Check Valve
45	1	O-RING, Spindle
49	1	O-RING, Trapped Line Pressure
53	1	O-RING, Venturi
60	3	SPACER, High Pressure Seal
61	3	SEAL, Piston, Oil

Item numbers 24, 34, 35, 38, 44, 54, and 59 are service kits and include all parts shown within the box. Certain items may only be available as a part of a kit.

LIMITED PRESSURE WASHER WARRANTY

GENERAC PORTABLE PRODUCTS (hereafter referred to as the COMPANY) warrants to the original retail purchaser, the pressure washer manufactured by the COMPANY to be free from defects in material and workmanship for the period(s) set forth below from the date of original purchase. This warranty is not transferable. The term “original purchaser” means the person for whom the pressure washer is originally purchased.

Warranty Schedules

Electric Power Washer	1 year (does not apply to commercial or rental applications)		
		CONSUMER*	COMMERCIAL*
All Other Engine-driven	Engine:	Warranted solely by Engine Manufacturer	Warranted solely by Engine Manufacturer
	Battery:	Warranted solely by Battery Manufacturer	Warranted solely by Battery Manufacturer
	Pump:	1 year	90 days

*** NOTE: For the purpose of this warranty “consumer” use means personal residential household use by original purchaser. “Commercial” use means all other uses, including rental, construction, commercial and income producing purposes. Once a pressure washer has experienced commercial use, it shall thereafter be considered a commercial use pressure washer for the purposes of this warranty.**

During said warranty period, the COMPANY will, at its option, repair or replace any part which, upon examination by the COMPANY or COMPANY-Authorized Dealers, is found to be defective under normal use and service**. All transportation costs under warranty, including return to the factory if necessary, are to be borne by the purchaser and prepaid by the purchaser.

**** NORMAL WEAR: As with all mechanical devices, pressure washers need periodic parts service and replacement to perform well. This warranty does not cover repair when normal use has exhausted the life of a part or pressure washer pump.**

This warranty does not include: Used products and demonstration equipment. Parts, such as GUNS, HOSES, WANDS, NOZZLES, BATTERIES or wear items such as quick couplers, oil, gauges, belts, o-rings, filters, pump packing, etc. Pumps which have been run without water supplied. Damage or malfunctions resulting from: accidents, abuse, modifications, alterations, or improper servicing. Freezing or chemical deterioration. Normal maintenance such as adjustments, fuel system cleaning and obstruction (due to chemical, dirt, carbon or lime, etc.).

THIS WARRANTY IS IN PLACE OF ALL OTHER WARRANTIES, EXPRESS OR IMPLIED, SPECIFICALLY, THE COMPANY MAKES NO OTHER WARRANTIES AS TO MERCHANTABILITY OR FITNESS FOR A PARTICULAR PURPOSE. THE DURATION OF ANY IMPLIED WARRANTIES WHICH CANNOT BE DISCLAIMED IS LIMITED TO THE TIME PERIOD AS SPECIFIED IN THE EXPRESS WARRANTY. LIABILITY FOR CONSEQUENTIAL, INCIDENTAL, OR SPECIAL DAMAGES UNDER ANY AND ALL WARRANTIES IS EXCLUDED, EVEN IF SUCH DAMAGES ARE A DIRECT RESULT OF THE COMPANY'S NEGLIGENCE. THE COMPANY ALSO DISCLAIMS ANY RESPONSIBILITY FOR INCIDENTAL OR CONSEQUENTIAL DAMAGES SUCH AS THE LOSS OF TIME OR THE USE OF THE POWER EQUIPMENT, OR ANY COMMERCIAL LOSS DUE TO THE FAILURE OF THE EQUIPMENT; AND ANY IMPLIED WARRANTIES ARE LIMITED TO THE DURATION OF THIS WRITTEN WARRANTY.

Some states do not allow limitations on how long an implied warranty lasts, or the exclusion or limitation of incidental or consequential damages, so the above limitations or exclusions may not apply to you. This warranty gives you specific legal rights and you may also have other rights, which vary from state to state.

For service, see your nearest COMPANY-Authorized warranty service facility or call 1-877-544-0982. Warranty service can be performed only by a COMPANY-Authorized service facility. This warranty will not apply to service at any other facility. At the time of requesting warranty service, evidence of original purchase date must be presented.

Generac Portable Products

Jefferson, Wisconsin U.S. A.