



6 HP Gas Pressure Washer

Model 95618

SET UP AND OPERATING INSTRUCTIONS



Diagrams within this manual may not be drawn proportionally.

Due to continuing improvements, actual product may differ slightly from the product described herein.

Distributed exclusively by Harbor Freight Tools®.

3491 Mission Oaks Blvd., Camarillo, CA 93011

Visit our website at: <http://www.harborfreight.com>



**Read this material before using this product.
Failure to do so can result in serious injury.
SAVE THIS MANUAL.**

Copyright© 2007 by Harbor Freight Tools®. All rights reserved. No portion of this manual or any artwork contained herein may be reproduced in any shape or form without the express written consent of Harbor Freight Tools.

For technical questions or replacement parts, please call 1-800-444-3353.

Specifications

Gas Engine	6HP OHV Mitsubishi Engine, 3600 RPM, Recoil Start, Uses Unleaded Fuel, 20 Oz. Engine Oil Capacity, 8.3 Gal. Fuel Capacity (3.8L).
Environmental	Approved by EPA (Environmental Protection Agency) Approved by CARB (California Air Resources Board)
Pressure Washer	2800 PSI Rated, Cast Iron Cylinder Sleeve, Brass Axial Pump
Pump Dimensions	23-5/8"L x 19-1/2"W x 36-3/4"T
Washer Gun	Safety Trigger Activated; for cold water use only.
Water Output	2.5 Gallons per Minute
High Pressure Hose	27 Foot Long High Pressure Hose
Cart and Wheels	Built in Cart with 8"D x 2" Wheels
Features	Standard Garden Hose Connector for Water Supply Thermal Overload Protection and Unloader Valve on Pressure Washer



Save This Manual



You will need the manual for the safety warnings and precautions, assembly instructions, operating and maintenance procedures, parts list and diagram. Keep your invoice with this manual. Write the invoice number on the inside of the front cover. Keep the manual and invoice in a safe and dry place for future reference.

Safety Warnings and Precautions

WARNING: When using tool, basic safety precautions should always be followed to reduce the risk of personal injury and damage to equipment. Read and adhere to all warnings and safety precautions before use.

Read all instructions before using this tool!

-  **Carbon Monoxide Hazard.** Operate pressure washer in well ventilated area only. Carbon Monoxide is created when engine is running and is a DEADLY gas when inhaled. Carbon Monoxide is a colorless, odorless gas. Early signs of Carbon Monoxide poisoning resemble Flu symptoms such as headache, dizziness or nausea. If you notice these signs, turn off engine and immediately move to a well ventilated area.
-  **Fire Hazard.** Do not fill gas tank when engine is running or hot. Do not operate engine near spilled gasoline. Clean spilled gasoline before starting engine. Do not store or handle gasoline near pilot light, electrical equipment or open flame. Do not smoke near gasoline. **Gasoline fuel and fumes are flammable and potentially explosive.** Use proper fuel handling procedures. Always have multiple ABC class fire extinguishers in the area when handling fuel.

3.  **Injection Hazard.** The high pressure water jet produced by this tool can cut skin or cause injury to hands or eyes. Do not allow spray to strike you and do not spray toward people or animals. Do not spray the tool itself or any electrical source.
4.  **Burn Hazard.** The engine and high pressure pump become hot during operation. Do not touch the engine or pump until they have cooled down after use.
5. **Keep work area clean.** Cluttered areas invite injuries.
6. **Observe work area conditions.** Do not use machines or power tools in unsafe locations. Don't expose to rain. Keep work area well lit.
7. **Keep children away.** Children must never be allowed in the work area. Do not let them handle machines, tools, gasoline or oil.
8. **Store idle equipment.** When not in use, tools must be stored in a dry location to inhibit rust. Always lock up tools and keep out of reach of children.
9. **Use the right tool for the job.** Do not attempt to force a small tool or attachment to do the work of a larger industrial tool. There are certain applications for which this tool was designed. It will do the job better and more safely at the rate for which it was intended. Do not modify this tool and do not use this tool for a purpose for which it was not intended.
10. **Dress properly.** Do not wear loose clothing or jewelry as they can be caught in moving parts. Protective, electrically non-conductive clothes and non-skid footwear are recommended when working. Wear restrictive hair covering to contain long hair.
11. **Use eye and ear protection.** Always wear ANSI approved impact safety goggles, heavy rubber boots, work gloves and hearing protection during use. During pressure washing debris can fly back in your face, or into other property, people or animals. Use extreme caution to prevent unintended spray injury.
12. **Do not overreach.** Keep proper footing and balance at all times. Do not reach over or across running machines.
13. **Maintain tools with care.** Keep tools maintained and clean for better and safer performance. Follow instructions for lubricating and changing accessories. Inspect tool hoses periodically and, if damaged, have them repaired by an qualified technician. The handles must be kept clean, dry, and free from oil and grease at all times.
14. **Turn OFF power.** Turn OFF engine and water supply when not in use.

15. **Remove adjusting keys and wrenches.** Check that keys and adjusting wrenches are removed from the tool or machine work surface before turning engine on.
16. **Avoid unintentional starting.** Be sure the water supply is in the Off position when not in use. Do not carry the spray handle with your finger on the trigger, whether or not engine is operating.
17. **Stay alert.** Watch what you are doing, use common sense. Do not operate any tool when you are tired.
18. **Take caution as some woods contain preservatives such as copper chromium arsenate (CCA) which can be toxic.** When high pressure spraying extra care should be taken to avoid inhalation and minimize skin contact.
19. **Check for damaged parts.** Before using any tool, any part that appears damaged should be carefully checked to determine that it will operate properly and perform its intended function. Check for alignment and binding of moving parts; any broken parts or mounting fixtures; and any other condition that may affect proper operation. Any part that is damaged should be properly repaired or replaced by a qualified technician. Do not use the tool if any switch does not turn On and Off properly.
20. **Guard against electric shock.** Prevent water spray into any electrical source such as a power outlet or extension cord.
21. **Replacement parts and accessories.** When servicing, use only identical replacement parts. Use of any other parts will void the warranty. Only use accessories intended for use with this tool. Approved accessories are available from Harbor Freight Tools.
22. **Do not operate tool if under the influence of alcohol or drugs.** Read warning labels on prescriptions to determine if your judgment or reflexes are impaired while taking drugs. If there is any doubt, do not operate the tool.
23. **Maintenance.** For your safety, service and maintenance should be performed regularly by a qualified technician.
24. **Use only Cold Water and/or pressure washer detergent as the active propellant in this tool.** Do not use detergents not designed for pressure washers, caustic materials, solvents or any flammable materials in this machine. Use of any such material can cause injury, or damage this tool or personal property.
25. **During use, do not allow the high pressure hose to come in contact with any hot part of the engine or pump.** Damage to the hose may occur possibly causing the hose to burst or leak under high pressure.

26. **In case of emergency during use, immediately release the trigger on the spray handle, then turn the engine off.** Do not set the spray handle down without turning off the engine. Then shut off gas supply to engine. (Refer to engine manufacturer's manual for fuel shut off procedures.)
27. **Avoid tipping over the pressure washer.** Only use on a level solid and stable surface.
28. **Never leave the engine running for more than 3 minutes without spraying.** Do not leave the pressure washer unattended while the engine is running.
29. **Use tools with both hands when required.** This tool requires the use of two hands to maintain tool stability and keeps hands away from operating parts of the tool.
30. **People with pacemakers should consult their physician(s) before use.** Electromagnetic fields in close proximity to heart pacemaker could cause pacemaker interference or pacemaker failure. Caution is necessary when near engine's magneto or recoil starter.
31. **Never touch the water jet.** Never touch the water jet or point it at people or animals. Injury may result.
32. **Clean up fuel spills immediately.** Dispose of fluids and cleaning materials in accordance with local, state or federal regulations. Store oily rags in a metal container. Store gasoline in a well ventilated, secure locker.
33. **Do not smoke and do not allow fire flame or electrical ignition sources near the pressure washer or any fuel or flammable materials.**
34. **Keep grounded electrically conductive tools and appliances away from any source of flammable materials.** Electrical items can cause ignition of flammable fumes and materials.
35. **Do not refill the fuel tank on the pressure washer while the engine is running or hot.** Do not operate the pressure washer if there are any leaks in the fuel system.
36. **Use only the types and grades of fuel, oil and other lubricants recommended by the engine manufacturer.**
37. **WARNING:** The brass components of this product contain lead, a chemical known to the State of California to cause birth defects or other reproductive harm. (California Health and Safety Code § 25249.5, *et. seq.*)
38. The warnings, cautions, and instructions discussed in this instruction manual cannot cover all possible conditions and situations that may occur. It must be understood by the operator that common sense and caution are factors which cannot be built into this product, but must be supplied by the operator.

Unpacking

When unpacking, check to make sure the parts shown in the photo below and in the diagrams on pages 13 and 14 are included.

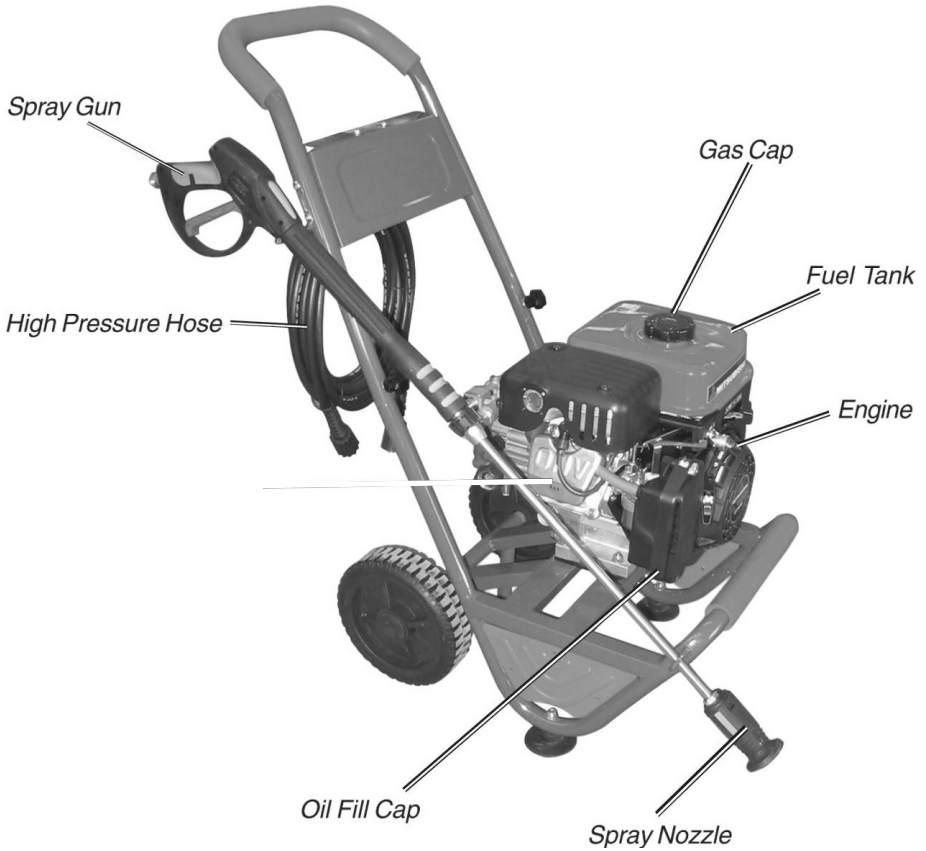

If any parts are missing or broken, please call Harbor Freight Tools at the number on the cover of this manual.

Checking Pump's Oil Level

1. The Oil pump is filled with 80 ml of SAE 75W/90 oil at the factory. Under normal conditions there is no reason to add any oil or change the oil. It is however recommended that the customer verify the pump's oil level before the initial use.
2. Remove the temporary white plastic Oil Plug by turning it counterclockwise. Use a measuring device, like a thin wooden stick (not included), as a dipstick. Place the stick all the way in until it touches the bottom of the Pump's Oil reservoir. See Figure A below.
3. Remove the stick and measure the amount of oil at the end of the stick. There should be about one inch of oil covering the end of the stick as shown in Figure B. Add SAE 75W/90 oil if needed.

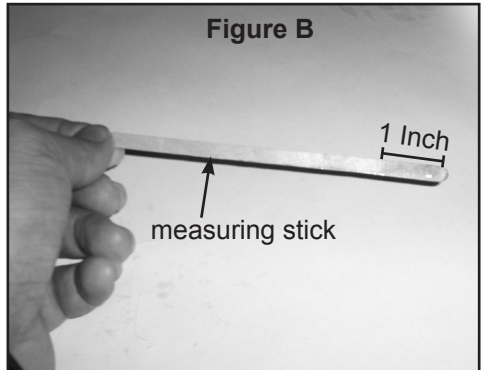
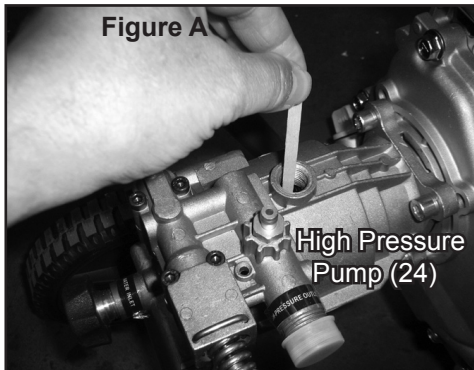

4. Do not put the same oil plug into the High Pressure Pump (24). There is a yellow plastic oil plug (included) that has a small breather hole in it. That breather plug must be used whenever the Pressure Washer is used. The white plastic plug (without the breather hole) should be used when transporting only.

Assembly

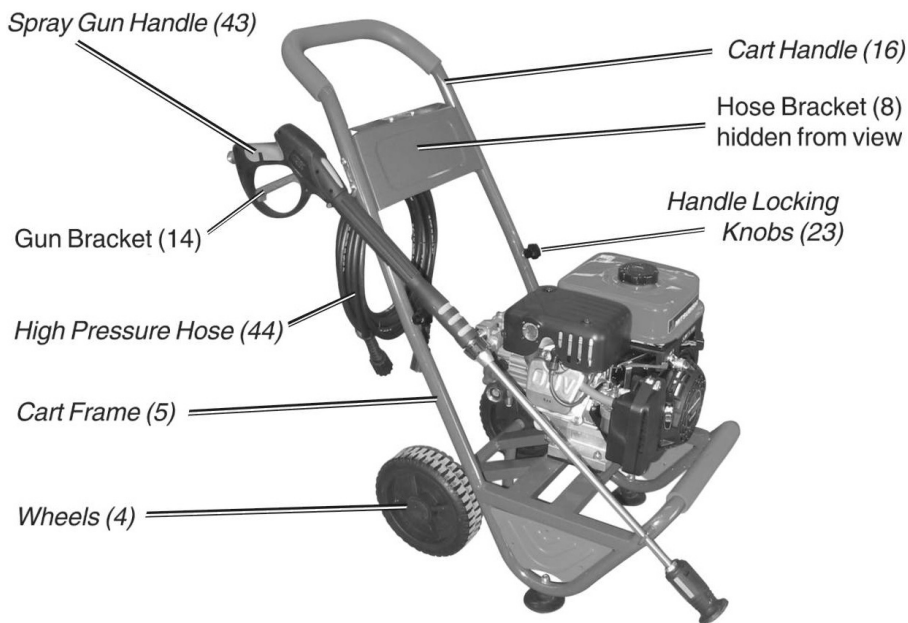

Note: Please refer to the photo above and the table and diagram on pages 13 and 14 when reading this section and assembling your pressure washer.

1. Attach the Cart Handle (16) to the Cart Frame (5) as shown in the photo below. Secure in place using the Handle Locking Knobs (23) with Flat Washers (21) and Spring Washers (22). Tighten Securely.
2. Attach the Wheels (4) to the Cart Frame (5) using the Lock Nuts (2) and Flat Washers (3). Press Wheel Covers (1) in place to cover axle ends.
3. Connect the High Pressure Hose (44) to the High Pressure Pump (24) by screwing in place clockwise. Secure tightly.
4. Attach High Pressure Hose (44) to Spray Gun Handle (43) by screwing clockwise. Tighten securely.
5. Coil the High Pressure Hose (44) and hang it on the Hose Bracket (8). Hang the Spray Gun on the Gun Bracket (14).
6. Connect a garden hose water supply to the garden hose connector.

Using Detergent

CAUTION! To avoid injury, ONLY run pressure washer detergent through the Detergent Suction Hose (46).

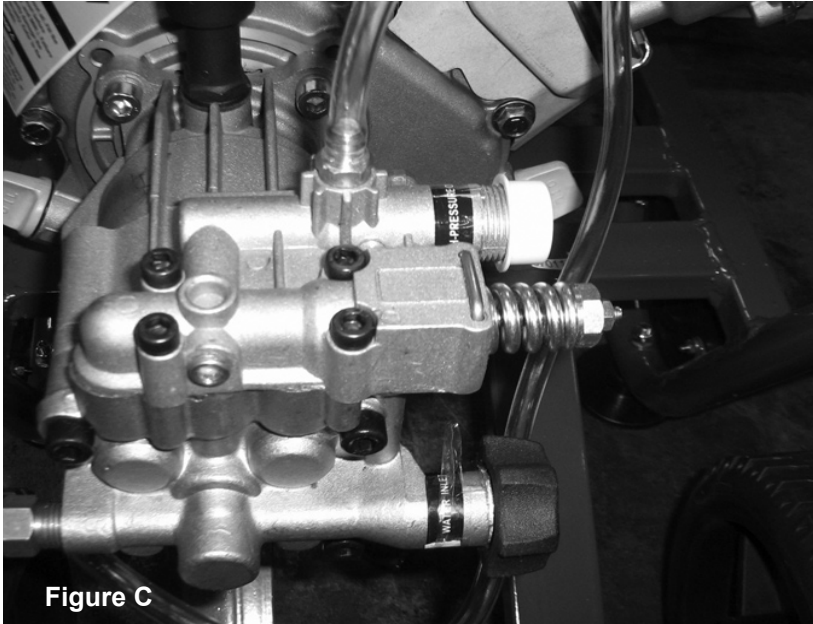

1. Press the supplied Detergent Suction Hose (46) onto the fitting on top of the pump. Place the other end of the hose into the detergent container or bottle. See Figure C.

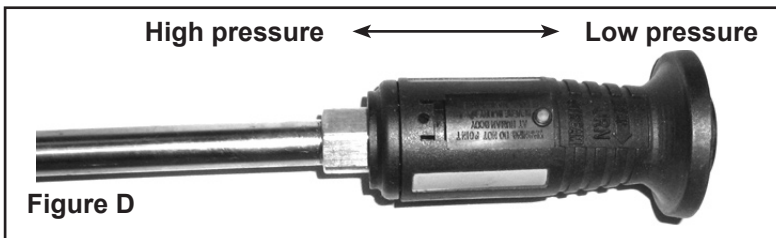

2. Do not dilute the detergent. The detergent sprays out at low pressure only. Slide the Spray Nozzle out for low pressure. The pressure washer will draw the detergent up through the Detergent Suction Hose (46) and mix the water and detergent automatically, at about a 6% detergent 94% water ratio. See Figure D.

Important Guidelines for Water Supply

1. **Do not leave engine running without spraying water.** If engine is left running for more than three (3) minutes without discharging water, excess pressure can cause damage to the pump seals and / or high pressure hose.
2. **The water supply provided through the garden hose must be at least 3 gallons per minute for this pressure washer to operate at maximum level.** Use only a standard 3/4" diameter garden hose for water supply, smaller hoses may not provide enough water flow. Test your water supply before operation by measuring the time required to fill a gallon bucket.
3. **Only use clean water supply.** Dirty or recycled "grey" water may contain impurities which can damage the pump or seals. Never use corrosive or flammable fluids.

Engine Setup

Refer to the engine manufacturer's manual for complete directions on proper engine setup, operation and maintenance.

1. Before starting the engine check the engine oil level. Unscrew the Oil Cap, and read the oil level on the dipstick (which is attached to the underside of the Oil Cap). If the level is low, fill to the proper level before starting. Use only clean, high quality engine oil meeting the engine manufacturer's specifications.

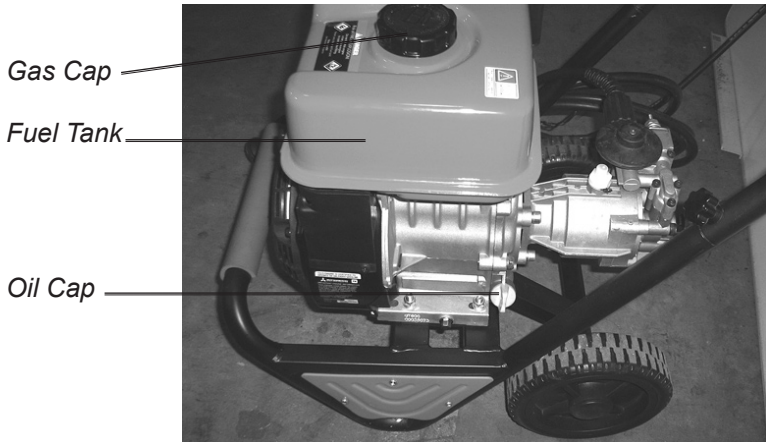

2. Remove Gas Cap and fill the Fuel Tank with unleaded gasoline. Do not over-fill. Be careful not to spill gasoline. Clean any spills before starting engine.

Operation

1. Pick up the Spray Gun (43) and point it in a safe direction. Squeeze the Spray Gun Trigger until all internal air is released, and a steady flow of water comes out. Then release the Spray Trigger.
2. Turn the Fuel Valve (D) to the open position (see engine photo below).
3. Turn the Speed Control Lever (C) all the way to the left, or fast position (see photo below).

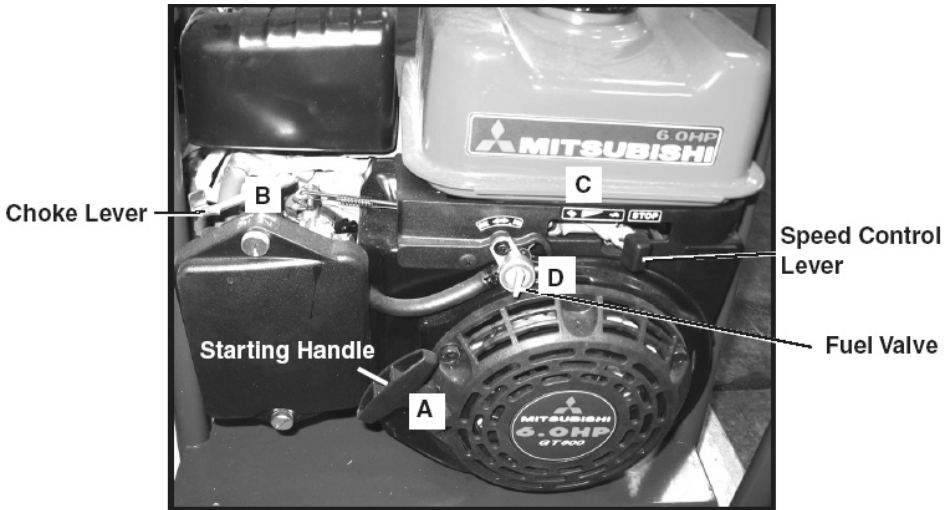

4. Move the Choke Lever (B) all the way to the left, or closed position (see photo above).
5. Pull the Starting Handle (A) (shown above in photo) lightly until you feel resistance. Then, pull it completely out. The engine should start up. If the engine does not start after a few tries, refer to Engine Manufacturer's Troubleshooting Tips. Slowly release the Starting Handle.
6. Adjust the Speed Control Lever (C) for the desired speed and subsequent output water pressure. Open the Choke Lever (B) to the right.
7. Hold the Spray Gun (43) with both hands and begin spraying. Do not allow the engine to run for more than three minutes without spraying.

Turning Off the Pressure Washer

1. Turn the Speed Control Lever (C) to the right, or stop position. The engine will stop.
2. Turn the Fuel Valve (D) up to the left, or closed position (see photo page 9).

Operation (Continued)

3. Turn off the water supply faucet.
4. Point the nozzle in a safe direction, then press the Spray Gun Trigger Handle to release water and pressure.
5. Disconnect the water supply hose from the Water Inlet Connector. (See photo page 9).

Cleaning Recommendations

Clean an inconspicuous test area first to avoid damaging the surface: Always begin with the fan spray at a distance of about 3-5 feet from the surface being cleaned to avoid damaging the surface of the object. Make sure that the test area is clear of people and water prone/delicate objects. If a pressure washing detergent is to be used, apply the detergent to this area as well. After cleaning this area, switch off the pressure washer and inspect the area carefully for any damage or discoloration. If any damage is noted from the pressure setting, use a lighter setting when cleaning the rest of the area. If damage or discoloration is noted from the detergent, do not use it when cleaning.

First, pass over the area with a light cleaning, and then more thoroughly clean it.

Page 10

For a vertical or sloped surface:

- a. Wash from the top down.
- b. If possible, direct the stream in the same direction as the slope towards a draining area. This will enable better drainage and therefore better cleaning.

For a flat surface:

- a. If a thin layer of water accumulates on the surface, periodically use the stream to direct this water towards the drainage.
- b. After the major cleaning is done, sweep the surface with the stream to help direct loose debris toward the drainage.

Hold the Spray Gun (43) at about a 45° angle and steadily sweep the stream back and forth. Do not point the spray directly at the surface to be cleaned. If a head-on angle is used, dirt may be embedded in the surface being cleaned. Follow a steady, consistent pace during cleaning; this will help prevent stripes or discoloration afterwards. If streaking or uneven cleaning is noted at the end of a project, go over the edges of the streaks with a wide fan pattern to help blend these lighter areas in.

If several different surfaces are to be cleaned, be careful not to damage any of the less solid surfaces while trying to clean the harder ones. This is espe-

cially a concern when cleaning tile and grout, bricks and mortar, or stones and mortar.

If wood is being cleaned, be careful not to damage it. Wood will usually require resurfacing (sanding) and re-coat with a surface protectant (wood, stain, varnish) after it has dried again. Try to avoid leaving water on a wooden surface; doing so can harm the surface.

Maintenance

1. After each use, wipe down the entire unit with a clean cloth. Do not use solvents.
2. Store the pressure washer in a clean and dry location, away from anything flammable.
3. If water is leaking from any connections during operation, shut down the Pressure Washer and retighten all connections.
4. **Maintain the engine regularly according to the maintenance instructions provided in the engine’s manual.**
5. Check the High Pressure Pump’s oil level whenever it is serviced. If needed, add SAE 75W/90 oil (80ml when full). See page 7 for instructions.

PUMP MAINTENANCE CHART*					
Maintenance Type	Before Use	After Use	Hours of operation		
			Weekly / 10 hr.	150 hr.	200 hr.
Inspect tool for damage	X				
Wipe off with clean, moist cloth Check for Pump Oil and Water Leaks		X	X		
Clean Filters			X		
Pump Oil Change				X	
Seal change and regulator/unloader/relief valve maintenance				X	
Valve Change					X

***Note:** This maintenance Chart is intended solely as a general guide. If performance decreases, check systems immediately. The maintenance needs of each pump will differ depending on factors such as duty cycle, temperature, cleanness of pumped liquid, and inlet feed conditions. Many maintenance procedures will need to be performed by a qualified technician.

Troubleshooting

Symptom	Possible Cause	Solution
Engine will not start	<ol style="list-style-type: none"> 1. Gas tank empty 2. Low oil level 3. Choke is not in correct position 4. Engine throttle set too low 5. Pressure build up in pump 	<ol style="list-style-type: none"> 1. Fill gas tank 2. Add oil 3. Close choke 4. Increase throttle setting 5. Squeeze trigger to release pressure
Does not produce high pressure	<ol style="list-style-type: none"> 1. Diameter of water supply hose too small 2. Water supply is restricted 3. Not enough water supply 	<ol style="list-style-type: none"> 1. Replace garden hose with a ¾ inch hose 2. Check water supply hose for kinks, leaks, or blockage 3. Open water faucet all the way
Output pressure varies	<ol style="list-style-type: none"> 1. Not enough water supply 2. Water inlet screen is clogged 3. Nozzle is clogged 4. Nozzle has mineral build up 	<ol style="list-style-type: none"> 1. Check water supply hose for kinks, leaks, or blockage. Open faucet all the way 2. Remove inlet screen and rinse out 3. Remove nozzle and clean 4. Remove nozzle and clean with vinegar

Parts List

Part	Description	QTY.
1	Wheel Cover	2
2	Locknut	2
3	Flat Washer	2
4	Wheel	2
5	Cart Frame	1
6	Spring Washer	4
7	Screw	4
8	Hose Bracket	1
9	Nut	2
10	Spring Washer	2
11	Flat Washer	2
12	Label	1
13	Screw	4
14	Gun Bracket	1
15	Screw	2
16	Cart Handle	1
17	Upper Bumper	1
18	Nut	4
19	Spring Washer	4
20	Flat Washer	4
21	Flat Washer	2
22	Spring Washer	2
23	Handle Locking Knobs	2

Part	Description	QTY.
24	High Pressure Pump	1
25	6HP Engine	1
26	Lock Nut	4
27	Motor Mount Plate	1
28	Lower Bumper	1
29	Left Cart Side Plate	1
30	Screw	4
31	Flat Washer	4
32	Lock Nut	2
33	Flat Washer	2
34	Foot Pad	2
35	Flat Washer	2
36	Screw	2
37	Nut	6
38	Spring Washer	6
39	Flat Washer	6
40	Right Cart Side Plate	1
41	Screw	6
42	Plug	2
43	Spray Gun	1
44	High Pressure Hose	1
45	Pin	1
46	Detergent Suction Hose	1

PLEASE READ THE FOLLOWING CAREFULLY

THE MANUFACTURER AND/OR DISTRIBUTOR HAS PROVIDED THE PARTS DIAGRAM IN THIS MANUAL AS A REFERENCE TOOL ONLY. NEITHER THE MANUFACTURER NOR DISTRIBUTOR MAKES ANY REPRESENTATION OR WARRANTY OF ANY KIND TO THE BUYER THAT HE OR SHE IS QUALIFIED TO MAKE ANY REPAIRS TO THE PRODUCT OR THAT HE OR SHE IS QUALIFIED TO REPLACE ANY PARTS OF THE PRODUCT. IN FACT, THE MANUFACTURER AND/OR DISTRIBUTOR EXPRESSLY STATES THAT ALL REPAIRS AND PARTS REPLACEMENTS SHOULD BE UNDERTAKEN BY CERTIFIED AND LICENSED TECHNICIANS AND NOT BY THE BUYER. THE BUYER ASSUMES ALL RISK AND LIABILITY ARISING OUT OF HIS OR HER REPAIRS TO THE ORIGINAL PRODUCT OR REPLACEMENT PARTS THERETO, OR ARISING OUT OF HIS OR HER INSTALLATION OF REPLACEMENT PARTS THERETO.

LIMITED 1 YEAR WARRANTY

Harbor Freight Tools Co. makes every effort to assure that its products meet high quality and durability standards, and warrants to the original purchaser that this product is free from defects in materials and workmanship for the period of one year from the date of purchase (90 days if used by a professional contractor or if used as rental equipment). See engine manufacturer's warranty which covers engine. This warranty does not apply to damage due directly or indirectly, to misuse, abuse, negligence or accidents, repairs or alterations outside our facilities, normal wear and tear, or to lack of maintenance. We shall in no event be liable for death, injuries to persons or property, or for incidental, contingent, special or consequential damages arising from the use of our product. Some states do not allow the exclusion or limitation of incidental or consequential damages, so the above limitation of exclusion may not apply to you. THIS WARRANTY IS EXPRESSLY IN LIEU OF ALL OTHER WARRANTIES, EXPRESS OR IMPLIED, INCLUDING THE WARRANTIES OF MERCHANTABILITY AND FITNESS.

To take advantage of this warranty, the product or part must be returned to us with transportation charges prepaid. Proof of purchase date and an explanation of the complaint must accompany the merchandise. If our inspection verifies the defect, we will either repair or replace the product at our election or we may elect to refund the purchase price if we cannot readily and quickly provide you with a replacement. We will return repaired products at our expense, but if we determine there is no defect, or that the defect resulted from causes not within the scope of our warranty, then you must bear the cost of returning the product.

This warranty gives you specific legal rights and you may also have other rights which vary from state to state.

3491 Mission Oaks Blvd. • PO Box 6009 • Camarillo, CA 93011 • (800) 444-3353