

powerworks™

**1500 PSI / 1.3 GPM
ELECTRIC PRESSURE WASHER**

51092

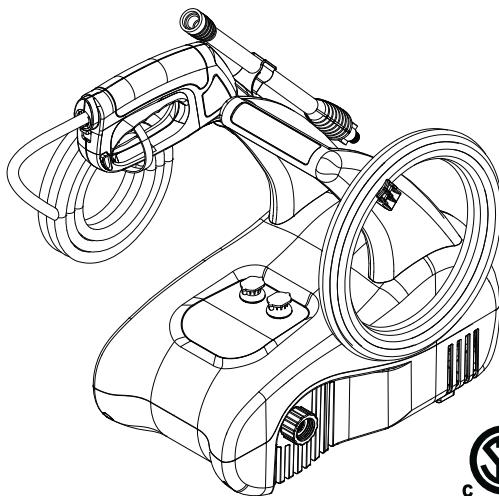

CSA[®]
c US
218549



OPERATOR'S MANUAL

TOLL-FREE HELPLINE: 1-855-470-2181
powerworkstools.com

⚠ Read all safety rules and instructions carefully before operating this tool.

TABLE OF CONTENTS

Introduction.....	3
Important Safety Instructions.....	3-4
Specific Safety Rules.....	5-6
Symbols.....	7-8
Electrical.....	9-10
Know Your Pressure Washer.....	11
Assembly.....	12-16
Operation.....	17-20
Maintenance.....	21-23
Troubleshooting.....	24-26
Warranty.....	27
Exploded View.....	28
Part List.....	29-30

PRODUCT SPECIFICATIONS

Universal Motor.....	120 V, 60 Hz, 13 Amps
Max. Pounds Per Square Inch Pressure*.....	1500 psi
Rated Gallons Per Minute*.....	1.3 gpm
Cleaning Units.....	1950 C.U
Maximum Inlet Water Temperature.....	104°F
Unit Weight.....	15.83lbs (7.18kg)



IMPORTANT SAFETY INSTRUCTIONS

W A R N I N G

Read and understand all instructions. Failure to follow all instructions listed below may result in electric shock, fire, and/or serious personal injury.

W A R N I N G

When using this product basic precautions should always be followed, including the following

READ ALL INSTRUCTIONS BEFORE USING THIS PRODUCT

- **To reduce the risk of injury**, close supervision is necessary when a product is used near children.
 - **Be thoroughly familiar with controls.** Know how to stop the product and release pressure quickly.
 - **Stay alert and exercise control.** Watch what you are doing and use common sense. Do not operate product when you are tired. Do not rush.
 - **Do not operate the product while under the influence of drugs, alcohol, or any medication.**
 - **Keep the area of operation clear of all people**, particularly small children, and pets.
 - **Don't overreach or stand on unstable support.** Keep proper footing and balance at all times.
 - **Follow the maintenance instructions specified in this manual.**
 - **This product is provided with a ground fault circuit interrupter built into the power cord plug.** If replacement of the plug or cord is needed, use only identical replacement parts.
-

W A R N I N G

Risk of injection or injury – Do not direct discharge stream at people or animals.

GROUND FAULT CIRCUIT INTERRUPTER PROTECTION

This pressure washer is provided with a ground fault circuit interrupter (GFCI) built into the plug of the power supply cord. This device provides additional protection from the risk of electric shock. Should replacement of the plug or cord become necessary, use only identical replacement parts that include GFCI protection.

SERVICING OF A DOUBLE-INSULATED APPLIANCE

In a double-insulated product, two systems of insulation are provided instead of grounding. No grounding means is provided on a double-insulated product, nor should a means for grounding be added to the product. Servicing a doubleinsulated product requires extreme care and knowledge of the system, and should be done only by qualified service personnel. Replacement parts for a double insulated product must be identical to the parts they replace. A doubleinsulated product is marked with the words "DOUBLE INSULATION" or "DOUBLE INSULATED." The symbol  may also be marked on the product.

IMPORTANT SAFETY INSTRUCTIONS

EXTENSION CORDS

DO NOT USE WITH EXTENSION CORD, USE DIRECT INTO RECEPTACLE.

Use only extension cords that are intended for outdoor use. These extension cords are identified by a marking "Acceptable for use with outdoor appliances; store indoors while not in use." Use only extension cords having an electrical rating not less than the rating of the product. Do not use damaged extension cords. Examine extension cord before using and replace if damaged. Do not abuse extension cord and do not yank on any cord to disconnect. Keep cord away from heat and sharp edges. Always disconnect the extension cord from the receptacle before disconnecting the product from the extension cord.

W A R N I N G

To reduce the risk of electrocution, keep all connections dry and off the ground. Do not touch plug with wet hands.

SAVE THESE INSTRUCTIONS

SPECIFIC SAFETY RULES

- Know your product. Read the operator's manual care-fully. Learn the machine's applications and limitations as well as the specific potential hazards related to this product.
- To reduce the risk of injury, keep children and visitors away. All visitors should wear safety glasses and be kept a safe distance from work area.
- Use right product. Don't force product or attachment to do a job it was not designed for. Don't use it for a purpose not intended.
- Dress properly. Do not wear loose clothing, gloves, neckties, or jewelry. They can get caught and draw you into moving parts. Rubber gloves and nonskid footwear are recommended when working outdoors. Also wear protective hair covering to contain long hair.
- Do not operate the equipment while barefoot or when wearing sandals or similar lightweight footwear. Wear protective footwear that will protect your feet and improve your footing on slippery surfaces.
- Exercise caution to avoid slipping or falling.
- Always wear eye protection with side shields marked to comply with ANSI Z87.1. Following this rule will reduce the risk of serious personal injury.
- Use only recommended accessories. The use of improper accessories may cause risk of injury.
- Check damaged parts. Before further use of the product, a guard or other part that is damaged should be carefully checked to determine that it will operate properly and perform its intended function. Check for alignment of moving parts, binding of moving parts, breakage of parts, mounting, and any other conditions that may affect its operation. A guard or other part that is damaged must be properly repaired or replaced by an authorized service center to avoid risk of personal injury.
- Never leave product running unattended. Turn power off. Don't leave product until it comes to a complete stop.
- Keep the motor free of grass, leaves, or grease to reduce the chance of a fire hazard.
- Follow manufacturer's recommendations for safe loading, unloading, transport, and storage of machine.
- Keep product dry, clean, and free from oil and grease. Always use a clean cloth when cleaning. Never use brake fluids, gasoline, petroleum-based products, or any solvents to clean product.
- Check the work area before each use. Remove all objects such as rocks, broken glass, nails, wire, or string which can be thrown or become entangled in the machine.
- Do not use product if switch does not turn it off. Have defective switches replaced by an authorized service center.
- Avoid dangerous environment. Don't expose to rain. Keep work area well lit.
- Do not abuse the cord. Never use the cord to carry the product or to disconnect the plug from an outlet. Keep cord away from heat, oil, sharp edges, or moving parts. Replace damaged cords immediately. Damaged cords increase the risk of electric shock.
- Ground Fault Circuit Interrupter (GFCI) protection should be provided on the circuit(s) or outlet(s) to be used for the product. Receptacles are available having built-in GFCI protection and may be used for this measure of safety.
- To reduce the risk of electric shock, this product has a polarized plug (one blade is wider than the other) and will require the use of a polarized extension cord. The plug will fit into a polarized extension cord only one way. If the plug does not fit fully into the extension cord, reverse the plug. If the plug still does not fit, obtain a correct polarized extension cord. A polarized extension cord will require the use of a polarized wall outlet. This plug will fit into the polarized wall outlet only one way. If the plug does not fit fully into the wall outlet, reverse the

SPECIFIC SAFETY RULES

- plug. If the plug still does not fit, contact a qualified electrician to install the proper wall outlet. Do not change the equipment plug, extension cord receptacle, or extension cord plug in any way.
- Make sure your extension cord is in good condition. When using an extension cord, be sure to use one heavy enough to carry the current your product will draw. A wire gauge size (A.W.G.) of at least 14 is recommended for an extension cord 25 feet or less in length. If in doubt, use the next heavier gauge. The smaller the gauge number, the heavier the cord. An undersized cord will cause a drop in line voltage resulting in loss of power and overheating.
 - Inspect extension cords periodically and replace if damaged. Keep handles dry, clean, and free from oil or grease.
 - Never direct a water stream toward people or pets, or any electrical device.
 - Before starting any cleaning operation, close doors and windows. Clear the area to be cleaned of debris, toys, outdoor furniture, or other objects that could create a hazard.
 - **Do not use acids, alkalines, solvents, flammable material, bleaches,** or industrial grade solutions in this product. These products can cause physical injuries to the operator and irreversible damage to the machine.
-

W A R N I N G

High pressure jets can be dangerous if subject to misuse. The jet must not be directed at people, animals, electrical devices, or the machine itself.

- **Keep the motor away from flammables and other hazardous materials.**
 - Check bolts and nuts for looseness before each use. A loose bolt or nut may cause serious motor problems.
 - Before storing, allow the motor to cool.
 - When servicing use only identical replacement parts. Use of any other parts may create a hazard or cause product damage.
 - ONLY use cold water.
 - Make sure minimum clearance of 3 feet is maintained from combustible materials.
 - Connect pressure washer only to an individual branch circuit.
 - Hold the handle and wand securely with both hands. Expect the trigger handle to move when the trigger is pulled due to reaction forces. Failure to do so could cause loss of control and injury to yourself and others.
 - Save these instructions. Refer to them frequently and use them to instruct other users. If you loan someone this product, loan them these instructions also.
-

W A R N I N G









Some dust created by power sanding, sawing, grinding, drilling, and other construction activities contains chemicals known to cause cancer, birth defects or other reproductive harm. Some examples of these chemicals are:

- Lead from lead-based paints
 - Crystalline silica from bricks and cement and other masonry products
 - Arsenic and chromium from chemically-treated lumber
- Your risk from these exposures varies, depending on how often you do this type of work. To reduce your exposure to these chemicals: work in a well ventilated area, and work with approved safety equipment, such as those dust masks that are specially designed to filter out microscopic particles
-

SAVE THESE INSTRUCTIONS

SYMBOLS

Some of the following symbols may be used on this product. Please study them and learn their meaning. Proper inter-pretation of these symbols will allow you to operate the product better and safer.





SYMBOL	NAME	DESIGNATION/EXPLANATION
V	Volts	Voltage
A	Amps	Current
Hz	Hertz	Frequency (cycles per second)
W	Watt	Power
no	No Load Speed	Rotational speed, at no load
~	Alternating Current	Type of current
.../min	Per Minute	Revolutions, strokes, surface speed, orbits etc., per minute
	Class II Construction	Double-insulated construction
	Safety Alert	Indicates a potential personal injury hazard.
	Read Operator's Manual	To reduce the risk of injury, user must read and understand operator's manual before using this product.
	Eye Protection	Always wear eye protection with side shields marked to comply with ANSI Z87.1.
	Wet Conditions Alert	Do not expose to rain or use in damp locations.
	Risk of Injection	To reduce the risk of injection or injury, never direct a water stream towards people or pets or place any body part in the stream. Leaking hoses and fittings are also capable of causing injection injury. Do not hold hoses or fittings.
	Kickback	To reduce the risk of injury from kickback, hold the spray wand securely with both hands when the machine is on.
	Electric Shock	Failure to use in dry conditions and to observe safe practices can result in electric shock.

SYMBOLS

Some of the following symbols may be used on this product. Please study them and learn their meaning. Proper interpretation of these symbols will allow you to operate the product better and safer.

SYMBOL	NAME	DESIGNATION/EXPLANATION
	Chemical Burns	To reduce the risk of injury or damage, DO NOT USE ACIDS, ALKALINES, BLEACHES, SOLVENTS, FLAMMABLE MATERIAL, OR INDUSTRIAL GRADE SOLUTIONS in this product.

The following signal words and meanings are intended to explain the levels of risk associated with this product.

SYMBOL	SIGNAL	MEANING
	DANGER	Indicates an imminently hazardous situation, which, if not avoided, will result in death or serious injury.
	WARNING	Indicates a potentially hazardous situation, which, if not avoided, could result in death or serious injury.
	CAUTION	Indicates a potentially hazardous situation, which, if not avoided, may result in minor or moderate injury.
	CAUTION	(Without Safety Alert Symbol) Indicates a situation that may result in property damage.

SERVICE

Servicing requires extreme care and knowledge and should be performed only by a qualified service technician. For service we suggest you return the product to your nearest **AUTHORIZED SERVICE CENTER** for repair. When servicing, use only identical replacement parts.

WARNING

To avoid serious personal injury, do not attempt to use this product until you read thoroughly and understand completely the operator's manual. If you do not understand the warnings and instructions in the operator's manual, do not use this product. Call POWERWORKS customer service for assistance.

WARNING



The operation of any power tool can result in foreign objects being thrown into your eyes, which can result in severe eye damage. Before beginning power tool operation, always wear safety goggles or safety glasses with side shields and, when needed, a full face shield. We recommend Wide Vision Safety Mask for use over eyeglasses or standard safety glasses with side shields. Always use eye protection which is marked to comply with ANSI Z87.1.

ELECTRICAL

⚠ WARNING

The double insulated system is intended to protect the user from shock resulting from a break in the product's internal insulation. Observe all normal safety precautions to avoid electrical shock.

DOUBLE INSULATED

Double insulation is a concept in safety in electric power tools, which eliminates the need for the usual three-wire grounded power cord. All exposed metal parts are isolated from the internal metal motor components with protecting insulation. Double insulated products do not need to be grounded.

NOTE: Servicing of a product with double insulation requires extreme care and knowledge of the system and should be performed only by a qualified service technician. For service, we suggest you return the product to your nearest authorized service center for repair. Always use original factory replacement parts when servicing.

ELECTRICAL CONNECTION

This product has a precision-built electric motor. It should be connected to a **power supply that is 120 volts, 60 Hz, AC only (normal household current)**. Do not operate this product on direct current (DC). A substantial voltage drop will cause a loss of power and the motor will overheat. If the product does not operate when plugged into an outlet, double-check the power supply.

EXTENSION CORDS (See Figure 1.)

When using a power tool at a considerable distance from a power source, be sure to use an extension cord that has the capacity to handle the current the product will draw. An undersized cord will cause a drop in line voltage, resulting in overheating and loss of power. Use the chart to determine the minimum wire size required in an extension cord. Only round jacketed cords listed by Underwriter's Laboratories (UL) should be used. When working outdoors with a product, use an extension cord that is designed for outside use. This type of cord is designated with "WA" or "W" on the cord's jacket. Before using any extension cord, inspect it for loose or exposed wires and cut or worn insulation. It is possible to tie the extension cord and power cord in a knot to prevent them from becoming disconnected during use. Make the knot as shown in figure 1, then connect the plug end of the power cord into the receptacle end of the extension cord. This method can also be used to tie two extension cords together..

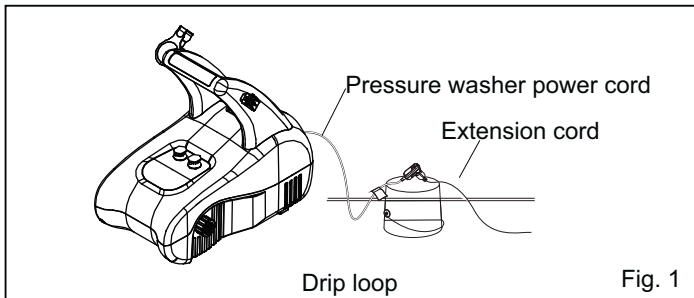

ELECTRICAL

⚠ WARNING

Keep the extension cord clear of the working area. Position the cord so that it will not get caught on lumber, tools, or other obstructions while you are working with a power tool. Failure to do so can result in serious personal injury.

⚠ WARNING

Check extension cords before each use. If damaged replace immediately. Never use the product with a damaged cord since touching the damaged area could cause electrical shock resulting in serious injury.

GROUND FAULT CIRCUIT INTERRUPTER

This unit is equipped with a Ground Fault Circuit Interrupter (GFCI), which guards against the hazards of ground fault currents. An example of ground fault current is the current that would flow through a person who is using an appliance with faulty insulation and, at the same time, is in contact with an electrical ground such as a plumbing fixture, wet floor, or earth.

GFCI plugs do not protect against short circuits, overloads, or shocks.

**Ampere rating (on product data plate)

	0-2.0	2.1-3.4	3.5-5.0	5.1-7.0	7.1-12.0	12.1-16.0
Cord Length	Wire Size (A.W.G.)					
25'		16	16	16	16	14 14
50'		16	16	16	14	14 12
100'		16	16	14	12	10 ---

**Used on 12 gauge - 20 amp circuit.

NOTE: AWG = American Wire Gauge

KNOW YOUR PRESSURE WASHER

The safe use of this product requires an understanding of the information on the tool and in this operator's manual as well as a knowledge of the project you are attempting. Before use of this product, familiarize yourself with all operating features and safety rules. (See Figure 2.)

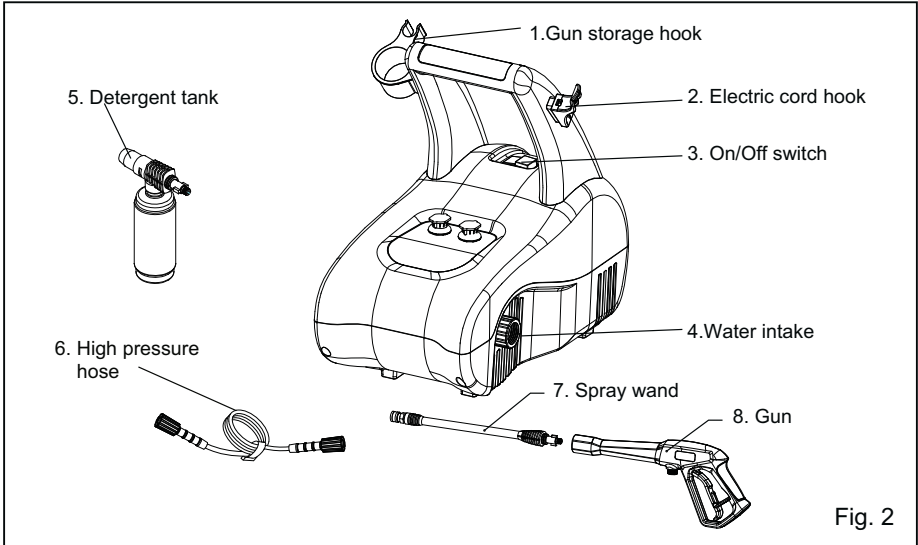

DETERGENT TANK

Remove the cap from the detergent tank and add detergent.

GFCI PLUG

The pressure washer is equipped with a GFCI plug to guard against the hazards of ground fault currents. This plug does not protect against short circuits, overloads, or shocks.

HIGH PRESSURE HOSE STORAGE

Once the high pressure hose is rolled, hang it on the top of the machine using the hook-and-loop strap to secure in place.

ON / OFF SWITCH

This switch turns the pressure washer on and off.

TRIGGER HANDLE

The trigger handle has a gripping surface that provides added control of the spray wand and helps reduce fatigue.

TRIGGER WITH LOCK-OUT

Pulling the trigger releases a stream of water for high pressure cleaning. The lock-out provides protection against unauthorized use.

UNPACKING

This product requires assembly.

■ Carefully remove the product and any accessories from the box. Make sure that all items listed in the packing list are included.

ASSEMBLY

WARNING

Do not use this product if any parts on the Packing List are already assembled to your product when you unpack it. Parts on this list are not assembled to the product by the manufacturer and require customer installation. Use of a product that may have been improperly assembled could result in serious personal injury.

UNPACKING

- Inspect the product carefully to make sure no breakage or damage occurred during shipping.
- Do not discard the packing material until you have carefully inspected and satisfactorily operated the product.
- If any parts are damaged or missing, please call 1-888-909-6757 for assistance.

PACKING LIST
• Pressure Washer
• Trigger Handle
• 20 ft. High Pressure Hose
• Wand Assembly
• Operator's Manual
• Detergent tank
• 0, 25 degree tips

WARNING

If any parts are damaged or missing do not operate this product until the parts are replaced. Use of this product with damaged or missing parts could result in serious personal injury.

WARNING

Do not attempt to modify this product or create accessories not recommended for use with this product. Any such alteration or modification is misuse and could result in a hazardous condition leading to possible serious personal injury.

WARNING

Do not connect to power supply until assembly is complete. Failure to comply could result in accidental starting and possible serious personal injury.

ASSEMBLY

CONNECTING THE WATER SUPPLY TO THE PRESSURE WASHER (See Figure 3.)

CAUTION :

Always observe all local regulations when connecting hoses to the water main. Some areas have restrictions against connecting directly to public drinking water supply to prevent the feedback of chemicals into the drinking water supply. Direct connection through a receiver tank or backflow preventer is usually permitted.

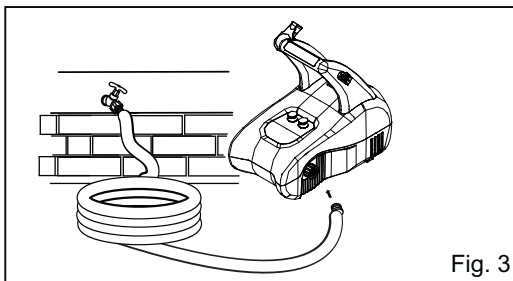

The water supply must come from a water main. NEVER use hot water or water from pools, lakes, etc. Before connecting the garden hose:

Before connecting the garden hose to the pressure washer:

- Run water through the hose for 120 seconds to clean any debris from the hose.
- Inspect the screen in the water intake.
- If the screen is damaged, do not use the machine until the screen has been replaced.
- If the screen is dirty, clean it before connecting the garden hose to the machine.

To connect the garden hose to the machine:

- Attach the garden hose to the pump inlet coupler.
- Straighten the garden hose.

NOTE: There must be a minimum of 10 feet of unrestricted garden hose between the water intake and the garden hose faucet or shut off valve (such as a "Y" shut off connector).

- With the hose faucet turned completely off, attach the garden hose to the water inlet. Tighten the water inlet collar by hand.

ASSEMBLY

ASSEMBLING WAND TO PRESSURE WASHER GUN (See Figure 5.)

- Installing Wand to Pressure Washer Gun
Insert the male bayonet end(1) of the wand into the female bayonet outlet(3)firmly .
While pushing in the wand firmly ,turn clockwise(2)until tabs lock into place to ensure a leak-free connection .

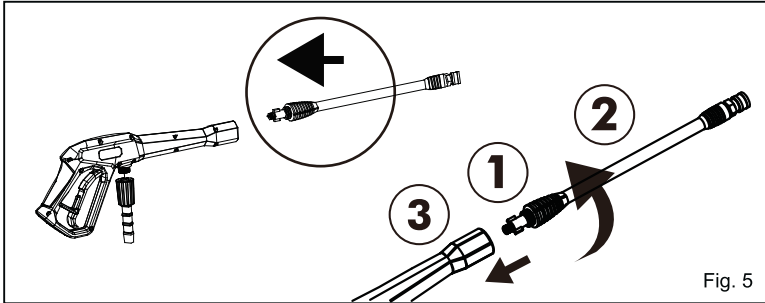

CONNECTING HIGH PRESSURE HOSE TO TRIGGER HANDLE (See Figure 6.)

- Connect the high pressure hose to the trigger handle.

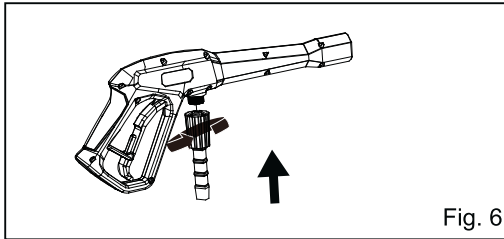

ASSEMBLY

DETERGENT BOTTLE (See Figure 7.)

- Insert the male bayonet end of the bottle into the female bayonet outlet firmly.
- While pushing in the bottle firmly, turn clockwise until tabs lock into place to ensure a leak-free connection.
- Fill bottle with approved pressure washer detergents / soaps only.

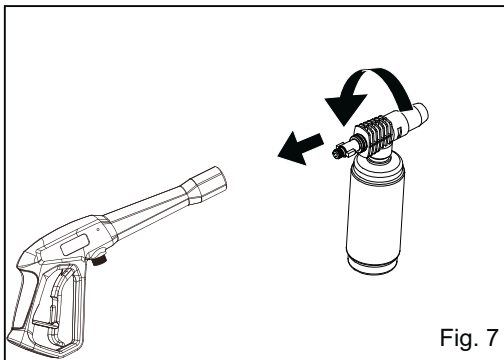

INSTALLING GUN HOLDER AND CORD RETENTION CLIPS (See Figure 8.)

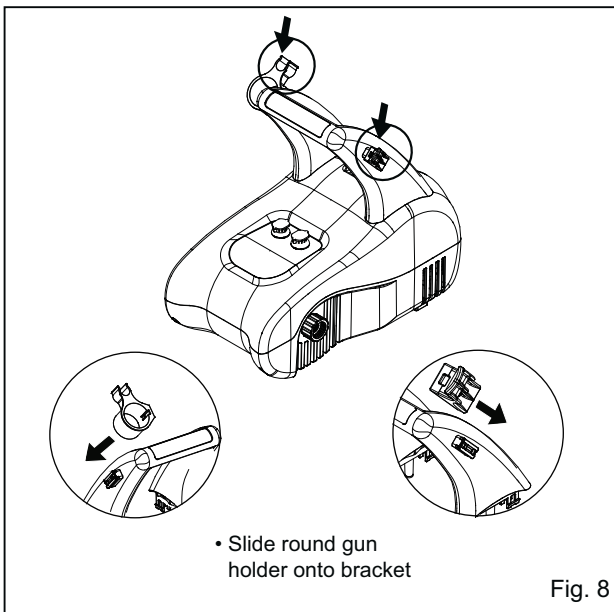

ASSEMBLY

CONNECTING THE GARDEN HOSE (See Figure 9.)

CAUTION :

Always observe all local regulations when connecting hoses to the water main. Some areas have restrictions against connecting directly to public drinking water supply to prevent the feedback of chemicals into the drinking water supply. Direct connection through a receiver tank or backflow preventer is usually permitted.

The water supply must come from a water main. NEVER use hot water or water from pools, lakes, etc. Before connecting the garden hose:

- Uncoil the garden hose.
- Run water through the garden hose for 120 seconds to clean any debris from the hose.
- Inspect the screen in the water intake.
- If the screen is damaged, do not use the machine until the screen has been replaced.
- If the screen is dirty, clean it before connecting the garden hose to the machine.
- With the hose faucet turned completely off, attach the end of the garden hose to the water intake. Tighten by hand.

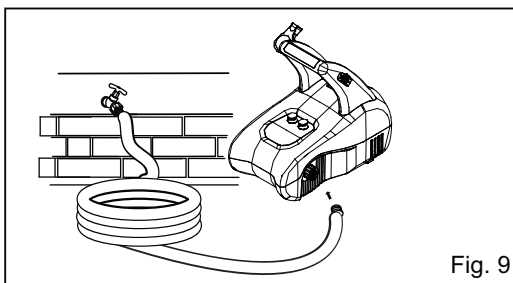

⚠ WARNING

Always use the pressure washer in the position shown, laying down. Never try to use in the upright position. Danger of tipping over and damage to the motor and/or pump may occur.

⚠ WARNING

Always ensure that the garden hose is connected to the unit and that the faucet is turned on, before the power to the unit is switched on. Pump damage will occur if these steps are not followed.

OPERATION

⚠ WARNING

Do not allow familiarity with the product to make you careless. Remember that a careless fraction of a second is sufficient to inflict serious injury.

⚠ WARNING

Always wear eye protection with side shields marked to comply with ANSI Z87.1. Failure to do so could result in objects being thrown into your eyes resulting in possible serious injury.

⚠ WARNING

Do not use any attachments or accessories not recommended by the manufacturer of this product. The use of attachments or accessories not recommended can result in serious personal injury.

⚠ WARNING

Never direct a water stream toward people or pets, or any electrical device. Failure to heed this warning could result in serious injury.

APPLICATIONS

You may use this product for the purposes listed below:

- **Using spray wand:** cleaning cars, boats, motorcycles, outdoor furniture, grills, and house siding

ADDING DETERGENT TO THE DETERGENT BOTTLE (See Figure 10.)

Use only detergents designed for pressure washers; household detergents, acids, alkalines, bleaches, solvents, flammable material, or industrial grade solutions can damage the pump. Many detergents may require mixing prior to use. Prepare cleaning solution as instructed on the solution bottle.

NOTE: Use a funnel, if needed, to prevent accidental spilling of the detergent outside the tank. If any detergent is spilled during the filling process, make sure the unit is cleaned and dried before proceeding.

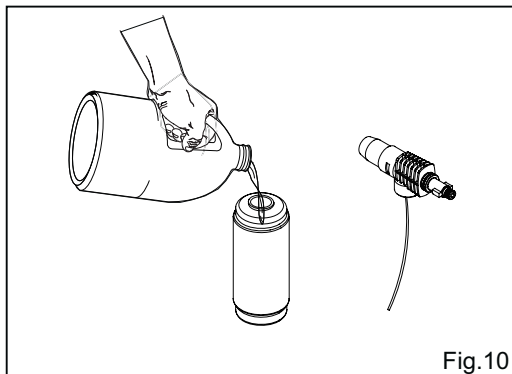

Fig.10

OPERATION

STARTING AND STOPPING THE PRESSURE WASHER (See Figure 11.)

CAUTION :

Do not run the pump without the water supply connected and turned on.

- Connect the garden hose.
 - Turn the garden hose on then squeeze the high pressure trigger to relieve air pressure. Once a steady stream of water appears, release the trigger.
 - After ensuring the On/Off switch is in the **OFF (O)** position, connect the pressure washer to the power supply.
-
- Press the reset button on the pressure washer's plug to make sure the unit is ready for operation.
 - Press **ON (I)** on the switch to start the motor.
 - To stop the motor, release the trigger and press **OFF (O)** on the switch.
-

⚠ WARNING

Hold the handle and wand securely with both hands. Expect the trigger handle to move when the trigger is pulled due to reaction forces. Failure to do so could cause loss of control and injury to yourself and others.

NOTE: AUTO ON/OFF SWITCH: This Pressure washer is equipped with an Auto Start/Stop feature. To operate: Press power switch On (I). Pump will pressurize and shut down immediately. Once the trigger of the gun is depressed the unit will turn on. Unit will shut off and be in standby mode when trigger is released.

Soap is applied under low pressure high volume for optimum performance. Soap cannot be applied under high pressure with this machine.

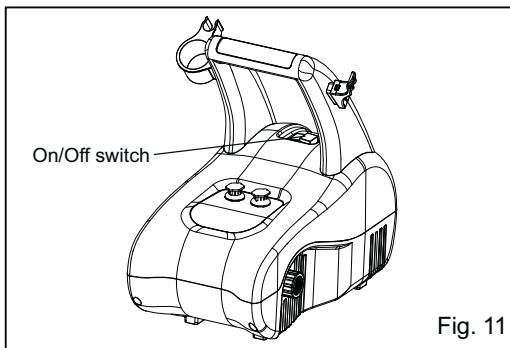

OPERATION

USING THE SPRAY WAND TRIGGER (See Figure 12.)

For greater control and safety, keep both hands on the trigger handle at all times.

- Pull back and hold the trigger to operate the pressure washer.
- Release the trigger to stop the flow of water through the nozzle.

TO ENGAGE THE LOCK-OUT:

- Push up on the lock-out until it clicks into the slot.

TO DISENGAGE THE LOCK-OUT:

- Push the lock-out down and into its original position.
-

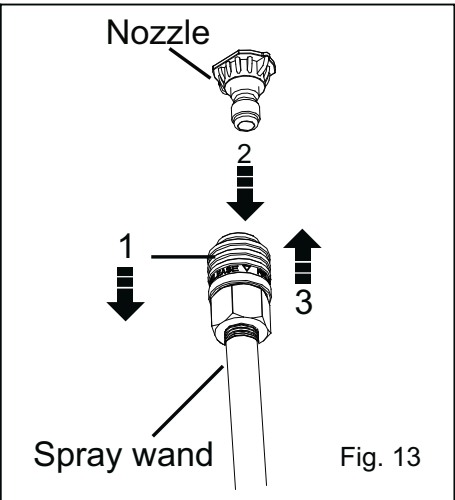
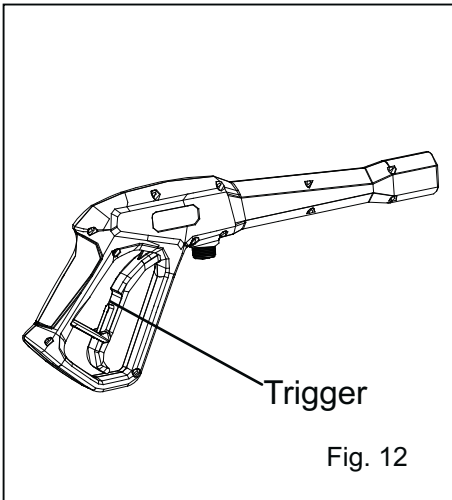

USING NOZZLE (See Figure 13.)

- 1-Pull back the quick-connect collar
- 2-Push the nozzle into place
- 3-Push the collar forward

NOTE: Always try nozzle in an inconspicuous area first.

OPERATION

⚠ WARNING

NEVER change nozzles without engaging the lock-out on the trigger handle and NEVER point the wand at your face or at others. The quick-connect feature contains small springs that could eject the nozzle with some force. Failure to heed this may cause personal injury.

- Turn off the pressure washer and shut off the water supply. Pull trigger to release water pressure.
- Engage the lock-out on the trigger handle.
- Pull back the quick-connect collar.
- Push the nozzle into place in the spray wand.
- Push the collar forward so that the nozzle is secured properly. Check to see that the nozzle is secure.

OPERATING THE PRESSURE WASHER (See Figure 14.)

Use only detergents designed for pressure washers. Many detergents may require mixing prior to use. Prepare cleaning solution as instructed on the solution bottle.

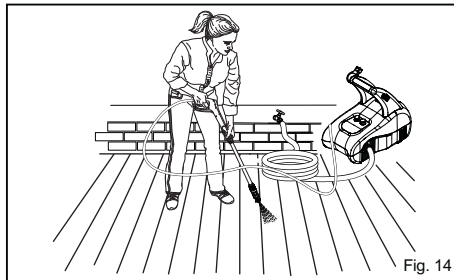

SOAP APPLICATION

Soap is applied under low pressure high volume for optimum performance. Soap can not be applied under high pressure with this machine.

To clean:

- Install the detergent bottle on the spray wand.
- Start the pressure washer and spray the detergent on a dry surface using long, even, overlapping strokes. To prevent streaking, do not allow detergent to dry on the surface.

To rinse:

- Using the desired tip, spray away from the rinsing surface for approximately 10 seconds to allow any remaining detergent to be flushed from the line.
- Start at the top of the area to be rinsed and work down, overlapping the strokes.

MOVING THE PRESSURE WASHER

To move the pressure washer:

- Turn the pressure washer off. Point nozzle in a safe direction
- and pull trigger to release water pressure.
- Disconnect the high pressure hose from the trigger handle.

MAINTENANCE

⚠ WARNING

When servicing, use only identical replacement parts. Use of any other parts may create a hazard or cause product damage..

⚠ WARNING

Always wear eye protection marked to comply with ANSI Z87.1. Failure to do so could result in objects being thrown into your eyes, resulting in possible serious injury.

GENERAL MAINTENANCE

Avoid using solvents when cleaning plastic parts. Most plastics are susceptible to damage from various types of commercial solvents and may be damaged by their use. Use clean cloths to remove dirt, dust, oil, grease, etc.

⚠ WARNING

Do not at any time let brake fluids, gasoline, petroleum-based products, penetrating oils, etc., come in contact with plastic parts. Chemicals can damage, weaken or destroy plastic which may result in serious personal injury.

Only the parts shown on the parts list are intended to be repaired or replaced by the customer. All other parts should be replaced at an authorized service center.

NOZZLE MAINTENANCE (See Figure 15.)

Excessive pump pressure (a pulsing sensation felt while squeezing the trigger) may be the result of a clogged or dirty nozzle.

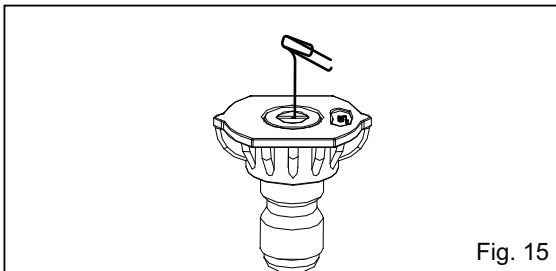

Fig. 15

MAINTENANCE

- Unplug the pressure washer.
- Turn off the pressure washer and shut off the water supply. Pull trigger to release water pressure.
- Remove the nozzle from the spray wand.

NOTE: Never point the spray wand at your face

Using a straightened paper clip or nozzle cleaning tool (not provided), free any foreign materials clogging or restricting the nozzle.

- Using a garden hose, flush debris out of nozzle by back flushing (running the water through the nozzle backwards or from the outside to the inside).
- Reconnect the nozzle to the spray wand.
- Turn on the water supply.

STORING THE PRESSURE WASHER

Store in a dry, covered area where the weather can't damage it.

It is important to store this product in a frost-free area. Always empty water from all hoses, the pump, and the detergent container before storing.

NOTE: Use of a pump saver will give you better performance and increase the life of the machine.

QUICK WINTERIZING PROCEDURE

If you cannot do the Optimum Winterizing procedure, you can still protect your pressure washer from winter-damage by doing below:

- Disconnect all water connections.
- Turn on the machine for a few second, until the remaining water in the pump exits. Turn off immediately.
- Do not allow high-pressure hose to become kinked.
- Store the machine and accessories in a room that does not reach freezing temperatures. Do not store near furnace or other sources of heat as it may dry out the pump seals.

CAUTION :

Drain gun assembly of any remaining water. Aim gun downwards and aqueeze trigger.

SHUTTING DOWN AND CLEANING UP

1. (if you are not using detergent, go directly to Step 2.) When you have finished using the detergent injection system, fill detergent bottle with clean water. Siphon water at low-pressure for one minute so that all detergent is flushed through system. Remove detergent bottle and rinse it thoroughly.
2. Disconnect the garden hose from the water inlet on the unit.
3. Press trigger to release any remaining water pressure.
4. Turn the switch to "OFF" (0) position.
5. Unlug the power cord from the outlet.
6. Engage gun safety lock.

WARNING

Turn off water supply and squeeze trigger to depressurize the unit. Failure to do so could result in personal injury due to discharge of high-pressure water.

MAINTENANCE

TAKING A BREAK

If leaving the pressure washer unattended then ensure the following.

- Engage gun safety lock.
 - Turn unit to “OFF” (O) position.
 - Unplug the power cord from the outlet.
-

C A U T I O N :

The use of a pump protector is recommended to prevent cold weather damage during storage over the winter months.

TROUBLESHOOTING

PROBLEM	POSSIBLE CAUSE	SOLUTION
Motor will not start.	On/Off switch is in the "OFF" (O) position.	Turn switch to the "ON" () position. Squeeze gun trigger.
	Power cord is not plugged in.	Plug in power cord.
	Extension cord is too long. Extension cord is not proper gauge. Extension cord is damaged.	Replace extension cord with either a 25' (7.6 m) 14 AWG cord or a 50' (15 m) 14 AWG cord.
	Electrical outlet does not supply adequate power.	Try a different outlet.
	Tripped pressure washer circuit breaker	Allow to cool, and restart unit.
Unit does not reach high pressure.	Diameter of garden hose is too small.	Replace with a 1" (25 mm) or 5/8" (16 mm) garden hose.
	Water supply is restricted.	Check garden hose for kinks, leaks and blockage.
	Not enough water supply.	Open water source fully.
	Water inlet filter is clogged.	Remove filter and rinse in warm water.
	Pump is sucking air.	Check that hoses and fittings are airtight. Turn "OFF" machine, and purge pump by squeezing trigger gun until a steady flow of water emerges through the nozzle.
Output pressure varies high and low.	Not enough inlet water supply.	Turn water on fully. Check garden hose for kinks, leaks or blockage
	Pump is sucking air.	Check that hoses and fittings are airtight. Turn "OFF" machine, and purge pump by squeezing trigger gun until a steady flow of water emerges through the nozzle.
	Water inlet filter is clogged.	Remove filter and rinse with warm water.

TROUBLESHOOTING

PROBLEM	POSSIBLE CAUSE	SOLUTION
Output pressure varies high and low. (continued)	Discharge nozzle is obstructed.	Blow out or remove debris with a fine needle.
	Calcified gun, hose or power nozzle.	Run distilled vinegar through detergent tank.
Unit does not reach high pressure.	Diameter of garden hose is too small.	Add more detergent.
	Detergent bottle or suction tube not properly connected.	Check connections.
	Detergent is too thick.	Dilute detergent.
	Filter on detergent suction tube is clogged.	Run warm water through filter to remove build-up.
	Damaged or clogged detergent suction tube.	Remove obstruction or replace detergent suction tube.
	Discharge nozzle is obstructed.	Blow out or remove debris with a fine needle.
Garden hose connection leaks.	Loose fittings.	Tighten fittings.
	Missing/worn rubber washer.	Insert new washer.
Spray wand, extension, or nozzle leaks.	Broken o-ring or plastic insert.	Call the Toll-Free Hotline.
Pump is noisy	Pump is sucking air	Check that hoses and fittings are airtight. Turn off machine and purge pump by squeezing trigger gun until a steady flow of water emerges through the nozzle.
	Water filter is clogged.	Remove water filter and rinse in warm water.
Water leaks from pump	Loose fittings.	Check that all fittings are tight.
	Water seals are damaged or worn.	Call the Toll-Free Hotline
Oil is dripping	Oil seals are damaged or worn.	Call the Toll-Free Hotline

TROUBLESHOOTING

<u>PROBLEM</u>	<u>POSSIBLE CAUSE</u>	<u>SOLUTION</u>
Motor buzzes but fails to run.	Supply voltage below minimum.	Verify that only the pressure washer is running on this circuit.
	System has residual pressure.	Turn unit "OFF", squeeze trigger on spray wand to release pressure, then turn unit "ON"
	Voltage loss due to extension cord.	Unplug any extension cords attached and plug the unit directly into the outlet.
	Pressure washer not used for long periods.	Call the Toll-Free Hotline.
	Residual friction among components. Unit might hum.	Disconnect water supply and power ON for 2 to 3 seconds, repeat couple times or until the motor starts.
No Water	Water supply is OFF.	Turn ON water supply.
	Kink in the garden hose.	Remove kink in garden hose.

NOTE: AUTO ON/OFF SWITCH: This Pressure washer is equipped with an Auto Start/Stop feature. To operate: Press power switch On (I). Pump will pressurize and shut down immediately. Once the trigger of the gun is depressed the unit will turn on. Unit will shut off and be in standby mode when trigger is released.

WARRANTY



POWERWORKS™ hereby warrants this product, to the original purchaser with proof of purchase, for a period of one (1) years against defects in materials, parts or workmanship. POWERWORKS™, at its own discretion will repair or replace any and all parts found to be defective, through normal use, free of charge to the customer. This warranty is valid only for units which have been used for personal use that have not been hired or rented for industrial/ commercial use, and that have been maintained in accordance with the instructions in the owners' manual supplied with the product from new.

ITEMS NOT COVERED BY WARRANTY:

1. Any part that has become inoperative due to misuse, commercial use, abuse, neglect, accident, improper maintenance, or alteration; or
2. The unit, if it has not been operated and/or maintained in accordance with the owner's manual; or
3. Normal wear, except as noted below;
4. Routine maintenance items such as draining the water to avoid freezing/ice damage to pump and components.
5. Normal deterioration of the exterior finish due to use or exposure.

POWERWORKS HELPLINE (1-855-470-2181) powerworkstools.com

Warranty service is available by calling our toll-free helpline, 9am to 5pm EST.
at **1-855-470-2181**

TRANSPORTATION CHARGES:

Transportation charges for the movement of any power equipment unit or attachment are the responsibility of the purchaser. It is the purchaser's responsibility to pay transportation charges for any part submitted for replacement under this warranty unless such return is requested in writing by POWERWORKS.

PARTS LIST

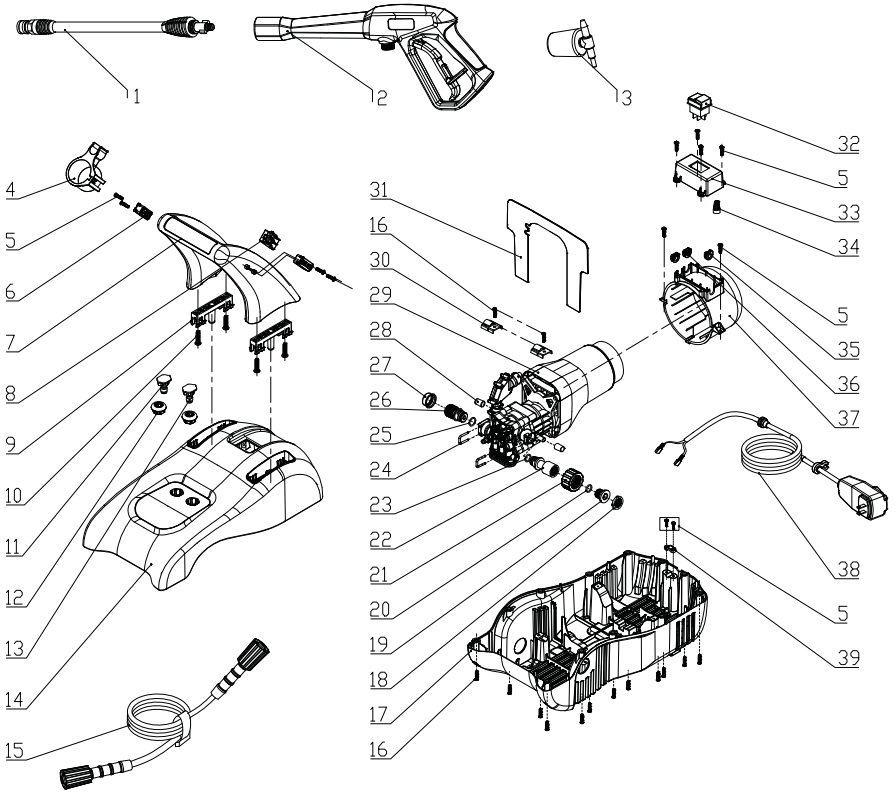

PARTS LIST

ITEM NO.	PART NO.	DESCRIPTION	QTY
1	31115661	Gun wand Assembly	1
2	31113661	Gun handle Assembly	1
3	31111368	Soap tank	1
4	34105380	Gun hook	1
5	32211316A	Screw	12
6	34106380	Gun hook base	2
7	34110380	Handle	1
8	34109380	Cord hook	1
9	34107380	Hook	2
10	32201363	Screw	4
11	31200363	O°nozzle	1
12	34205380	Rubber ring	2
13	31225363	25°nozzle	1
14	34112380	Upper housing	1
15	31203670	High pressure hose assembly	1
16	32209302A	Screw	14
17	34113380	Lower housing	1
18	31901301	Water inlet filter	1
19	33177307	Water inlet connector	1
20	34213301A	O ring	1
21	34124319	Water inlet nut	1
22	33204368	Water inlet conector	1
23	34219301A	O ring	1
24	33302365	U pin	2
25	34202368	O ring	1
26	33203368	Water outlet connector	1
27	34125304	Dust-proof cover	1
28	34203365	Shaking reduction cover	2
29	31100380	Motor and pump assembly	1
30	33301365	Orientation plate	2
31	34104380	Heat isolation board	1
32	36302301-1	Power swtich	1
33	34108380	Swtich box	1
34	36511154A	Wire nut	1
35	34204380	Seal ring	2
36	34201380	Seal ring	1
37	34114380	Motor cover	1
38	36401380	Power cord assembly	1
39	34119316A	Wire plate	1

power**works**TM

TOLL-FREE HELPLINE: 1-855-470-2181
powerworkstools.com