



**For Gas Pressure Washer Models:  
WPX2600, WPX2800, WPX3100**

2600PSI / 2GPM

2800PSI / 2.3GPM

3100PSI / 2.5GPM

# SAVE THESE INSTRUCTIONS

*Important safety instructions are included in this manual.*

## ⚠ WARNING

Operating, servicing and maintaining this equipment can expose you to chemicals including engine exhaust, carbon monoxide, phthalates, and lead, which are known to the State of California to cause cancer and birth defects or other reproductive harm. To minimize exposure, avoid breathing exhaust, do not idle the engine except as necessary, service your equipment in a well-ventilated area and wear gloves or wash your hands frequently when servicing your equipment. For more information go to [www.P65Warnings.ca.gov](http://www.P65Warnings.ca.gov).

### DISCLAIMERS:

All information, illustrations and specifications in this manual are based on the latest information available at the time of publishing. The illustrations used in this manual are intended as representative reference views only. Moreover, because of our continuous product improvement policy, we may modify information, illustrations and/or specifications to explain and/or exemplify a product, service or maintenance improvement. We reserve the right to make any change at any time without notice. Some images may vary depending upon which model is shown.

### ALL RIGHTS RESERVED:

No part of this publication may be reproduced or used in any form by any means – graphic, electronic or mechanical, including photocopying, recording, taping or information storage and retrieval systems – without the written permission of MWE Investments LLC.

## ⚠ DANGER



This manual contains important instructions for operating this pressure washer. For your safety and the safety of others, be sure to read this manual thoroughly before operating the pressure washer. Failure to properly follow all instructions and precautions can cause you and others to be seriously hurt or killed.

Specifications	WPX2600	WPX2800	WPX3100
Pressure - PSI/BAR	2600/179	2800/193	3100/213
Flow Rate - (GPM/LPM)	2.0/ 7.57	2.3/ 8.71	2.5/ 9.46
Water Temperature (°F/°C)	100/38 Max		
Hose Length (ft)	25	25	30
Soap Tank Capacity (L)	None	3.6	3.6
Nozzles	0°, 25°, Soap	0°, 15°, 40°, Soap	0°, 15°, 25°, 40°, Soap
Engine Displacement	161cc	173cc	208cc
Spark Plug Type	F7TC		
Spark Plug Gap (in/mm)	0.030/0.76 mm		
Fuel Capacity (L)	1.2	1.2	3.3
Recommended Oil	10W30		
Oil Capacity (oz/L)	14/0.4	20/0.6	20/0.6
On/Off Switch	Yes		

**HAVE QUESTIONS? DO NOT RETURN THIS PRODUCT TO THE STORE**  
**Email us at [service@wpowereq.com](mailto:service@wpowereq.com) or call 1-855-944-3571**

# HIGH ALTITUDE OPERATION

## NOTICE

This pressure washer is NOT equipped with an altitude carburetor modification. Even with a carburetor modification, engine horsepower will decrease about 3.5% for each 300 meter (1,000 foot) increase in altitude. The effect of altitude on horsepower will be greater if no carburetor modification is made. A decrease in engine horsepower will decrease the power output of the pressure washer. Contact our service team to order altitude kits.

### FOR YOUR RECORDS:

Date of Purchase:	
Pressure Washer Model Number:	
Purchased from Store/Dealer:	
Pressure Washer Serial Number:	

**IMPORTANT: KEEP YOUR PURCHASE RECEIPT TO ENSURE TROUBLE-FREE WARRANTY COVERAGE.**

### PRODUCT REGISTRATION

To ensure trouble-free warranty coverage, it is important you register your Westinghouse pressure washer. You can register your pressure washer by either:

1. Filling in the product registration form below and mailing to:

**Product Registration**  
MWE Investments LLC  
777 Manor Park Drive  
Columbus, OH 43228

2. Registering your product Online at [www.westinghouseportablepower.com/register-your-product/](http://www.westinghouseportablepower.com/register-your-product/)  
To register your pressure washer you will need to locate the following information:

---

## WESTINGHOUSE PRODUCT REGISTRATION FORM

### PERSONAL INFORMATION

### PRESSURE WASHER INFORMATION

First Name: \_\_\_\_\_ Model Number: \_\_\_\_\_

Last Name: \_\_\_\_\_ Serial Number: \_\_\_\_\_

Street Address: \_\_\_\_\_ Date Purchased: \_\_\_\_\_

Street Address: \_\_\_\_\_ Purchased From: \_\_\_\_\_

City, State, ZIP: \_\_\_\_\_

Country: \_\_\_\_\_

Phone Number: \_\_\_\_\_

E-Mail: \_\_\_\_\_



# TABLE OF CONTENTS

<b>SAVE THESE INSTRUCTIONS</b> .....	2	High-Pressure Hose & Spray Gun .....	19
<b>PRODUCT REGISTRATION</b> .....	3	High-Pressure Hose .....	19
For Your Records: .....	3	Spray Gun .....	19
Product Registration .....	3	Soap Siphon Hose .....	19
Product Registration Form .....	3	Nozzle .....	19
<b>SAFETY</b> .....	5	<b>AFTER EACH USE</b> .....	20
Safety Definitions .....	5	Long Term Storage .....	20
Safety Symbol Definitions .....	5	Storage 1 - 3 Months .....	20
General Safety Rules .....	6	Storage Greater Than 3 Months .....	20
Fuel Safety .....	8	Winter Storage .....	20
<b>ASSEMBLY</b> .....	9	Remove & Install the Pump .....	21
Wheel Assembly .....	9	<b>TROUBLESHOOTING</b> .....	22
Handle Assembly .....	9	<b>PRESSURE WASHER PARTS</b> .....	24
Nozzle Assembly .....	10	WPX2600 Exploded View .....	24
Hose Assembly .....	10	WPX2600 Engine View .....	26
<b>OPERATION</b> .....	11	WPX2800 Exploded View .....	28
Before Starting the Pressure Washer .....	11	WPX2800 Engine View .....	30
Adding/Checking Engine Fluids & Fuel .....	11	WPX3100 Exploded View .....	32
Adding Gasoline to the Fuel Tank .....	12	WPX3100 Engine View .....	34
Connecting the Water Supply .....	12		
Starting the Pressure Washer .....	13		
Stopping the Pressure Washer .....	14		
Normal Operation .....	14		
During an Emergency .....	14		
Selecting Nozzles .....	14		
Spraying Tips .....	15		
Spraying Soap .....	15		
Rinsing .....	16		
Cleaning the Soap Siphon Hose .....	16		
<b>MAINTENANCE</b> .....	16		
Maintenance Schedule .....	16		
Engine Oil Maintenance .....	17		
Engine Oil Specification .....	17		
Checking Engine Oil .....	17		
Adding Engine Oil .....	18		
Changing Engine Oil .....	18		
Air Filter Maintenance .....	18		
Cleaning the Air Filter .....	18		
Spark Plug Maintenance .....	19		
Pressure Washer Components .....	19		
Water Filter Screen .....	19		



# Westinghouse

# SAFETY

## SAFETY DEFINITIONS

The words DANGER, WARNING, CAUTION and NOTICE are used throughout this manual to highlight important information. Be certain that the meanings of these alerts are known to all who work on or near the equipment.



**This safety alert symbol appears with most safety statements. It means attention, become alert, your safety is involved! Please read and abide by the message that follows the safety alerts symbol.**

<b>⚠ DANGER</b>
Indicates a hazardous situation which, if not avoided, <i>will</i> result in death or serious injury.

<b>⚠ WARNING</b>
Indicates a hazardous situation which, if not avoided, <i>could</i> result in death or serious injury.

<b>⚠ CAUTION</b>
Indicates a hazardous situation which, if not avoided, <i>could</i> result in minor or moderate injury.

<b>NOTICE</b>
Indicates a situation which can cause damage to the pressure washer, personal property and/or the environment, or cause the equipment to operate improperly.

**NOTE:** Indicates a procedure, practice or condition that should be followed in order for the pressure washer to function in the manner intended.

## SAFETY SYMBOL DEFINITIONS



Burn Hazard



Burst/Pressure Hazard



Don't leave tools in the area



Electrical Shock Hazard



Explosion Hazard



Fall Hazard



Fire Hazard



High-Pressure Hazard



Lifting Hazard



Pinch-Point Hazard



Read Manufacturer's Instructions



Read Safety Messages Before Proceeding



Wear Personal Protective Equipment (PPE)

# SAFETY

## GENERAL SAFETY RULES

### DANGER

NEVER operate the pressure washer in an enclosed area. Engine exhaust contains carbon monoxide. Only operate the pressure washer outside and away from windows, doors and vents.

### WARNING



Gasoline and gasoline vapors are extremely flammable and explosive under certain conditions.



- ALWAYS refuel the pressure washer outdoors, in a well-ventilated area.
- NEVER remove the fuel cap with the engine running.
- NEVER refuel the pressure washer while the engine is running. Always turn the engine off and allow the pressure washer to cool before refueling.
- Only fill fuel tank with gasoline.
- Keep sparks, open flames or other form of ignition (such as match, cigarette, static electric source) away when refueling.
- NEVER overfill the fuel tank. Leave room for fuel to expand. Overfilling the fuel tank can result in a sudden overflow of gasoline and result in spilled gasoline coming in contact with HOT surfaces. Spilled fuel can ignite. If fuel is spilled on the pressure washer, wipe up any spills immediately. Dispose of rag properly. Allow area of spilled fuel to dry before operating the pressure washer.
- Wear eye protection while refueling.
- NEVER use gasoline as a cleaning agent.
- Store any containers containing gasoline in a well-ventilated area, away from any combustibles or source of ignition.
- Check for fuel leaks after refueling.
- Never operate the engine if a fuel leak is discovered.

### WARNING







This equipment produces a stream of water with enough high pressure to penetrate skin and its underlying tissues, which could result in amputation or other serious injury. Spray gun traps high-pressure water, even when engine is stopped and water is disconnected. Leaks caused by loose fittings or worn or damaged hoses can result in injection injuries.

**DO NOT TREAT FLUID INJECTION AS A SIMPLE CUT!** See a physician immediately!

- NEVER aim spray gun at people, animals or plants. Direct spray away from self and others.
- NEVER place hands in front of nozzle.
- ALWAYS point spray gun in safe direction while spraying and when relieving retained high pressure after stopping engine.
- DO NOT allow CHILDREN to operate pressure washer.
- NEVER leave spray gun unattended while machine is running.
- NEVER secure spray gun in open position.
- DO NOT twist nozzle while spraying.
- NEVER repair a high-pressure hose. ALWAYS replace it.
- NEVER repair leaking connections with sealant of any kind. ALWAYS use factory-recommended repair parts.
- NEVER hold onto the hose or fittings during operation.
- DO NOT allow high-pressure hose to contact muffler or other extremely hot surfaces.
- ALWAYS be certain spray gun, nozzles and hoses are correctly attached and in working order.
- NEVER use spray gun if trigger lock is not in working order.
- ALWAYS use spray gun, hoses and connections rated for pressure higher than your pressure washer's psi.
- NEVER attach or remove spray gun, nozzles or hoses while system is pressurized.

## GENERAL SAFETY RULES

<b>⚠ WARNING</b>	
	<ul style="list-style-type: none"> <li>• NEVER modify spray equipment.</li> <li>• ALWAYS wear protective clothing to protect eyes and skin from contact with sprayed materials.</li> </ul>
	NEVER aim spray in the direction of power source. Contact with power source can cause electric shock or burn.
	<p>Unexpected kickback while spraying can cause you to fall.</p> <ul style="list-style-type: none"> <li>• Use of pressure washer can create slippery surfaces and puddles. The operating area of this equipment should have adequate drainage to reduce the possibility of a fall due to slippery surfaces.</li> <li>• Be extremely careful if necessary to use the pressure washer from a ladder, scaffolding or any other similar location.</li> <li>• Use both hands to firmly grasp the spray gun while in use to avoid injury from high-pressure kickback.</li> </ul>
	NEVER use acids, toxic or corrosive chemicals, poisons, insecticides, or any kind of flammable solvent with this equipment. Only use detergents, cleaners and degreasers recommended for use in this pressure washer.
	ALWAYS wear chemical splash safety goggles that comply with ANSI Z87.1 when operating or in the vicinity of this equipment.
	ALWAYS remove any tools or other service equipment used during maintenance from the pressure washer before operating.

<b>NOTICE</b>	
	NEVER operate pressure washer with damaged or missing parts.
	NEVER modify any feature or component of the pressure washer.
	NEVER spray at glass when using the high-pressure nozzle (red). High-pressure spray may damage fragile items including glass.
	DO NOT exceed rated pressure when operating pressure washer.
	NEVER move pressure washer by pulling on any hoses. Always use handle to move pressure washer.
	Check components for ice forming on components when operating in cold weather.
	Remove the protective shipping caps from the pump's water inlet and outlet.
	Be sure the water supply is connected and turned on before starting the engine. Damage to the pump could occur and will void the warranty.
	Water supply must deliver a minimum of 3.8 gal (14.3 L) per minute and at least 30 psi (2 bar). Do not siphon standing water for the water supply. Water temperature must not exceed 100°F (37.7°C).
	DO NOT install a one-way valve, vacuum breaker or check valve at the pump's water inlet. Installing one of these devices at the pump's water inlet could cause damage to the pump and will void the warranty. Allow at least 10 feet (3 m) of unrestricted hose length between the pump's water inlet and a one-way valve, vacuum breaker or check valve.

# FEATURES

- ① **Spray Gun:** Controls the application of water onto the surface with trigger. Includes trigger lock.
- ② **Gun Lance:** Connects to end of spray gun and works with pressure nozzles included.
- ③ **Thermal Relief Valve:** When water reaches 125°F warm water will discharge from pump onto ground. Helps to prevent internal pump damage.
- ④ **Recoil Starter:** Pull to start engine.
- ⑤ **Oil Fill/Drain Plug:** Access to oil. Includes dipstick to measure oil levels.
- ⑥ **Air Filter:** Filters dust and debris out of the air intake to protect the engine.
- ⑦ **Pump:** Generates high pressure.
- ⑧ **Unloader Valve:** Controls pressure output.
- ⑨ **High Pressure Outlet:** Connection for high pressure hose.
- ⑩ **Water Inlet:** Connection for garden hose.
- ⑪ **Fuel Tank:** Fill with regular unleaded fuel. Do not overfill.
- ⑫ **High Pressure hose:** Connect one end to spray gun and the other end to the water pump on bottom of pressure washer.
- ⑬ **Fuel On/Off Switch:** Turns fuel supply to the engine on and off.
- ⑭ **Choke:** Prepares a cold engine for starting.
- ⑮ **Nozzles:** Varying sizes for various high pressure cleaning applications.
- ⑯ **Chemical/Soap Tank:** Siphons detergent into the low pressure stream. Automatically turns on when using black soap nozzle. Only use pressure washer safe detergents (some units may not have this tank).
- ⑰ **Oil Drain Plug:** Used to drain engine oil.
- ⑱ **Engine On/Off Switch:** Turn this switch “ON” before using the recoil starter. Turn to “OFF” to stop the engine.
- ⑲ **Chemical/Soap Tube Connections:** Connect chemical/soap clear tube to tank and pump.
- ⑳ **Nozzle Cleaning Tool:** Used to clean nozzles.

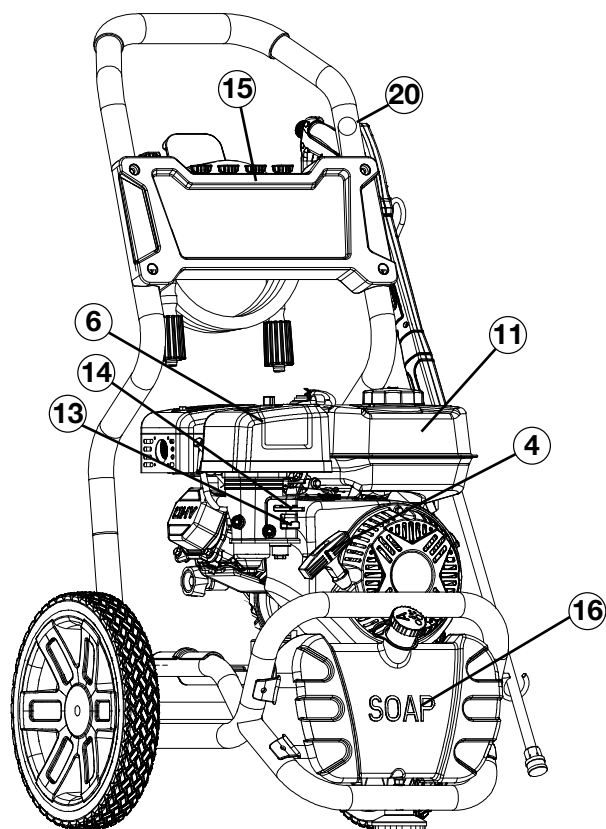

WPX3100 Shown

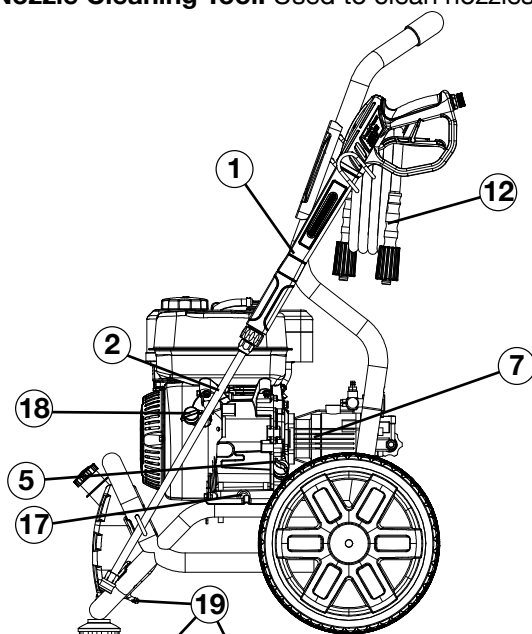

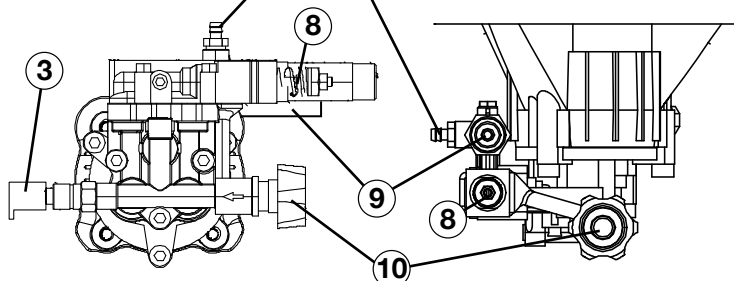

WPX3100 Pump



WPX2600/2800 Pump

# UNPACKING

## UNPACKING THE PRESSURE WASHER

<b>⚠ CAUTION</b>	
	Always have assistance when lifting the pressure washer. The pressure washer is heavy; lifting it could cause bodily harm.
	Avoid cutting on or near staples to prevent personal injury.

The following tools are required:

- Box cutter or similar device
- 10 mm wrench

1. Carefully cut the packing tape on top of the carton.
2. Fold back top flaps to reveal the owner's manual. Remove owner's manual and save it for reference.
3. Carefully cut two sides of the carton to remove the pressure washer.

## COMPONENTS

Verify the contents against the list below. If any parts are missing, please locate an authorized Westinghouse dealer at [www.wpowereq.com](http://www.wpowereq.com) or call 1-855-944-3571.

High-Pressure Hose (1)

Wheels (2)

Spray Gun Bracket (1) with Nuts (2)

Wheel Axle Lock Pin (2)

Wheel Axle Pin (2)

Soap Hose (1)

Spare Parts: High-Pressure Hose O-Rings (2), Inlet Screens (2)

Spray Gun (1)

Spray Gun Lance (1)

Bottle of Oil SAE 10W30 (1)

Oil Funnel (1)

**NOTE: Soap and gasoline are not included**

## INSTALLING WHEELS AND FEET (WPX2600)



**BEFORE ASSEMBLING THE PRESSURE WASHER REVIEW THE SAFETY SECTION STARTING ON PAGE 5.**

1. Place pressure washer on a flat surface.
2. Place a piece of cardboard or other soft material to tip the pressure washer onto, to protect the frame paint and prevent the pressure washer from sliding. Tip the pressure washer onto its side.
3. Insert axle pin through wheel.

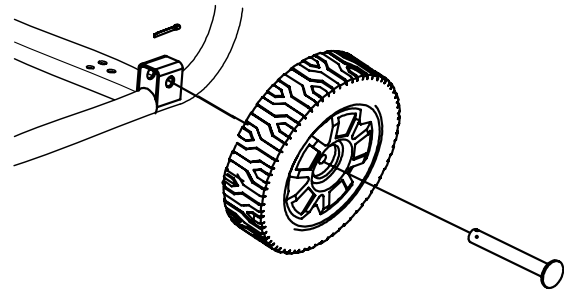

4. Install the wheel with axle pin through the axle bracket on the frame. The eye of the bolt should be facing toward the inside of the pressure.

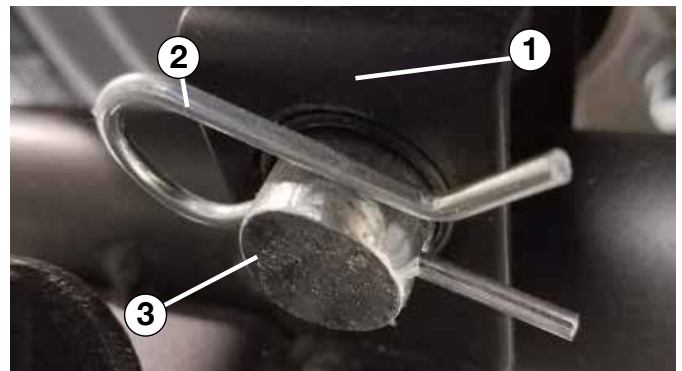

5. Install the hairpin cotter through the axle pin to lock it in place.
  - 1 - Axle Bracket
  - 2 - Hairpin Clip
  - 3 - Axle Pin
6. Repeat previous steps on other wheel.

# ASSEMBLY

## INSTALLING WHEELS AND FEET



**BEFORE ASSEMBLING THE PRESSURE WASHER REVIEW THE SAFETY SECTION STARTING ON PAGE 5.**

### ⚠ CAUTION



Never lift the pressure washer without assistance. The pressure washer is heavy and lifting without assistance could result in personal injury.



Never use the handles as a lifting point to support the entire weight of the pressure washer. Only use the handles to move the pressure washer by lifting the handles and using the wheels to move the pressure washer.



Use caution when collapsing the handles. Hands and fingers could get caught and pinched.

### NOTICE

Assembling the pressure washer will require tipping the unit. Make sure all engine oil and fuel are drained from the unit prior to assembling. Once assembled, the wheels are not intended for on-road use. The wheels are designed for use on this pressure washer only. Never tip the pressure washer after it has been fully assembled and filled with oil and fuel.

## INSTALLING HANDLE TO FRAME

1. Place Handle over snap pin.
2. Install handle to frame via snap pin by pushing in the pin & pressing down on handle until you hear a “snap” to lock in to place, as shown below.

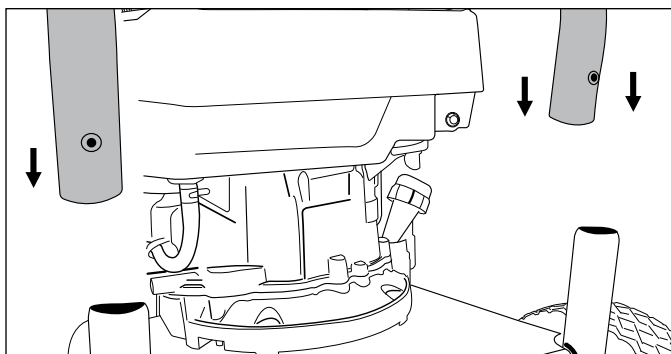

## SPRAY GUN HOLDER

1. Attach spray gun holder included to the frame with bolts provided.

## INSERTING SPRAY NOZZLES

1. Insert colored nozzles included into corresponding holder at the top of the pressure washer.

## WAND ASSEMBLY

1. Connect the spray lance to the spray gun and turn the fitting counterclockwise to tighten. Do not over-tighten. The fitting only needs to be hand-tight.
2. Install the high-pressure hose to the spray gun and tighten the hose fitting. Do not over-tighten. The fitting only needs to be hand-tight.

## HOSE ASSEMBLY

1. Locate the high pressure outlet fitting on the pump at the bottom of the unit.
2. Inspect the O-rings on both sides of the high pressure hose. Moisten the O-rings with water.
3. Connect the high pressure hose to high pressure outlet. Connect other end to spray wand.

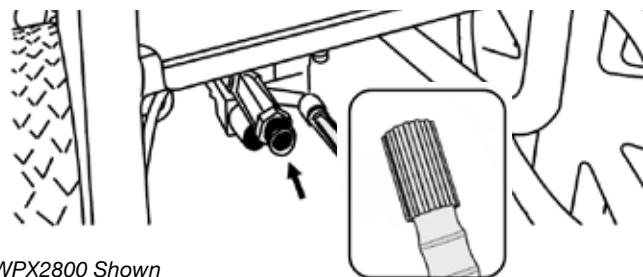

WPX2800 Shown

4. Attach clear siphon tube to the barbed inlet on the back of chemical/soap tank.
5. Attach the other end of the clear siphon tube to the barbed inlet on the pump.

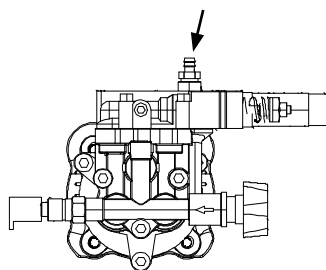

WPX3100 Connection

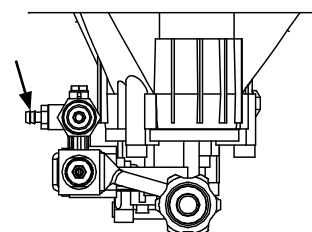

WPX2600/2800 Connection

## INSTALLING NOZZLE

1. Select desired nozzle for application. Lock spray gun.
2. Pull back collar at the end of the spray lance and insert the nozzle. Tug on the nozzle to make sure it is securely in place.

# OPERATION

## BEFORE STARTING THE PRESSURE WASHER



**BEFORE ASSEMBLING THE PRESSURE WASHER REVIEW THE SAFETY SECTION STARTING ON PAGE 5.**

Location Selection – Before starting the pressure washer, avoid exhaust and location hazards by verifying the following:

- You have selected a location to operate the pressure washer that is outdoors and well ventilated.
- You have selected a location with adequate drainage but still level enough to prevent the pressure washer from tipping over.
- You have selected a location that is at least 5 feet (1.5 m) away from any building, other equipment or combustible material.
- If the pressure washer is located close to a building, make sure it is not located near any windows, doors and/or vents.

<b>⚠ WARNING</b>	
	Always operate the pressure washer on a surface that will prevent the pressure washer from tipping over. Placing the pressure washer on a surface that may allow the pressure washer to tip over, could cause fuel and oil to spill. Spilled fuel can ignite if it comes in contact with an ignition source such as a very hot surface.

<b>NOTICE</b>
Operating the pressure washer on a surface with loose material such as sand or grass clippings can cause debris to be ingested by the pressure washer that could: <ul style="list-style-type: none"><li>• Block cooling vents</li><li>• Block air intake system</li></ul>

Check the following items before starting the engine:

1. Verify the pressure washer is properly assembled.
2. Check that recommended engine oil has been added to proper level in the engine crankcase.
3. Add recommended fuel to fuel tank.
4. Check for properly tightened hose connections.
5. Check to make sure there are no kinks, cuts or damage to high-pressure hose.
6. Provide a proper water supply at an adequate flow.

## ADDING/CHECKING ENGINE FLUIDS AND FUEL



**BEFORE ASSEMBLING THE PRESSURE WASHER REVIEW THE SAFETY SECTION STARTING ON PAGE 5.**

<b>⚠ DANGER</b>	
	Filling the fuel tank with gasoline while the pressure washer is running can cause gasoline to leak and come in contact with hot surfaces that can ignite the gasoline.

Before starting the pressure washer, always check the level of:

- Engine oil
- Gasoline in the fuel tank

Once the pressure washer is started and the engine gets warm, it is not safe to add gasoline to the fuel tank or engine oil to the engine while the engine is running or the engine and muffler are hot.

### INITIAL OIL FILL

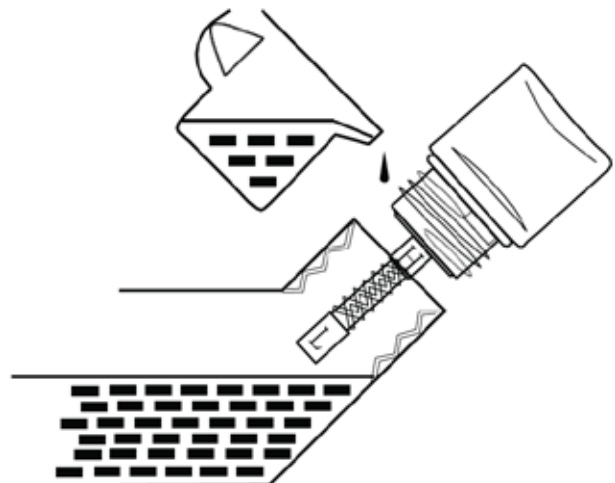

<b>NOTICE</b>
The pressure washer does not contain engine oil as shipped. Attempting to start the engine without adding engine oil can permanently damage internal engine components.

1. Before starting for the first time make sure to add oil to the engine.
2. Remove oil fill plug/dipstick and wipe clean.
3. Using the supplied oil bottle and funnel, slowly add engine oil to the engine. Stop frequently to check the level to avoid overfilling.
4. Add oil fill plug/dipstick and tighten.
5. Remove oil fill plug/dipstick to confirm oil level is correct.



# OPERATION

## ADDING GASOLINE TO THE FUEL TANK

⚠ WARNING	
	Never refuel the pressure washer while the engine is running.
	Always turn the engine off and allow the pressure washer to cool before refueling.

**Required Gasoline** - Only use gasoline that meets the following requirements:

- Unleaded gasoline only
- Gasoline with maximum 10% ethanol added
- Gasoline with an 87 octane rating or higher

**Filling the Fuel Tank** - Follow the steps below to fill the fuel tank:

1. Shut off the pressure washer.
2. Allow the pressure washer to cool down so all surface areas of the muffler and engine are cool to the touch.
3. Move the pressure washer to a flat level surface.
4. Clean area around the fuel cap.
5. Remove the fuel cap by rotating counterclockwise.
6. Slowly add gasoline into the fuel tank. Be very careful not to overfill the tank. The gasoline level should NOT be higher than the bottom of the filler neck.

### NOTICE

Take care when installing the fuel cap. Threads can be damaged if cap is incorrectly installed.

7. Install the fuel cap by rotating clockwise until it hits the stop, indicating the cap is completely installed.

### ⚠ CAUTION



Avoid prolonged skin contact with gasoline. Avoid prolonged breathing of gasoline vapors.

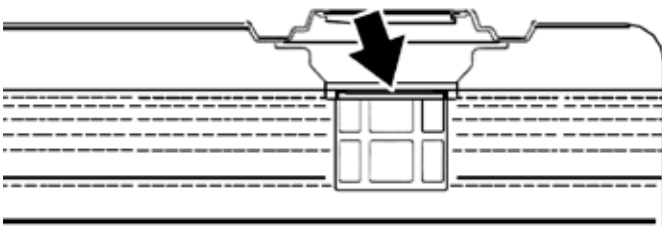

## CONNECTING THE WATER SUPPLY

### ⚠ CAUTION



Risk of eye injury. Spray can splash back or propel objects.

Always wear safety goggles when using this equipment.

NEVER substitute safety glasses for safety goggles.

### NOTICE

Do not start the engine without the water supply connected and turned on. Running the pump without water will damage the pump.

Water supply must deliver a minimum of 3.8 gal (14.3 L) per minute and at least 30 psi (2 bar). Do not siphon standing water for the water supply. Water temperature must not exceed 100°F (37.7°C).

Make sure water inlet screen is in place before attaching hose.

1. Run water through your garden hose to clear out any debris that may have been in the hose.
2. Inspect the water inlet screen to make sure it is in place and free of debris. Do not operate the pressure washer with a missing or damaged inlet screen.
3. Use the shortest hose possible to complete the job at hand. Using a longer hose may affect performance. Connect a garden hose that is not longer than 50 feet (15.2 m) to the water inlet fitting.
4. Hand tighten the fitting onto the hose. Do not over-tighten.

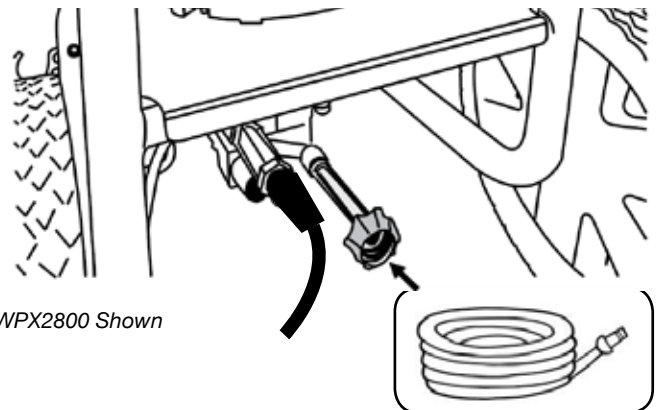

WPX2800 Shown

5. Turn the water on and inspect for leaks.
6. Squeeze the trigger on the gun and allow any air to bleed out of the hoses and the pump before starting the engine.
7. Confirm the soap hose is connected if using soap.

# OPERATION

## STARTING THE PRESSURE WASHER



**BEFORE ASSEMBLING THE PRESSURE WASHER REVIEW THE SAFETY SECTION STARTING ON PAGE 5.**

### NOTICE

Pressure washer may walk or move when used on hard surfaces. Be sure the unit is secure during operation.

The pump is equipped with a thermo valve. If the pump is run for an extended period of time without water flowing through it, it could overheat. If the pump gets to a certain temperature, the thermo valve will open and discharge warm water out the valve to allow cold water in to cool the pump.

Before attempting to start the pressure washer, verify the following:

- The engine is filled with engine oil (see Initial Oil Fill).
- The pressure washer is situated in a proper location (see Location Selection)

### ⚠ DANGER



Never operate the pressure washer in an enclosed area. Engine exhaust contains carbon monoxide that can kill in minutes. Only operate the pressure washer outside and away from windows, doors and vents.

1. Move pressure washer to a flat surface outside in a well ventilated area. Maintain 5ft distance from any surrounding buildings.
2. Check oil levels.
3. Flip the trigger lock lever up and lock the trigger in the **OFF** position.

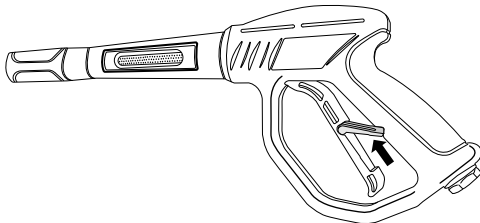

4. Make sure the water supply is turned on.
5. Point the thermo valve away from the work area you are washing to avoid being sprayed with warm water.
6. Move the engine ON/OFF switch to the **ON** position.

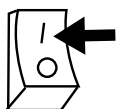

WPX2600/2800  
Switch

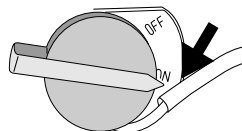

WPX3100  
Switch

7. Move the choke lever to the **CHOKE** position.

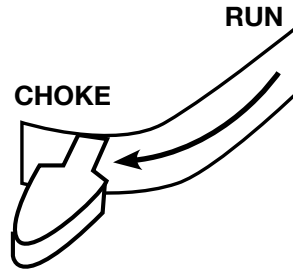

8. Slide the fuel valve to the **ON** position (WPX3100 only).

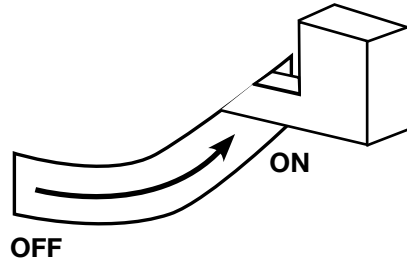

9. Firmly grasp and pull the starter handle slowly until you feel increased resistance. At this point, apply a rapid pull on the starter handle.

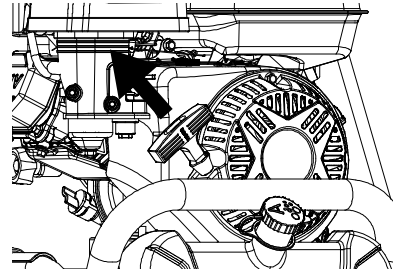

*NOTE: If the engine starts briefly and then shuts off, squeeze the trigger on the spray gun to relieve the pressure before trying to start the engine again.*

10. Once the engine starts, move the choke lever to the **RUN** position. Allow the engine to warm up slightly before beginning washing.

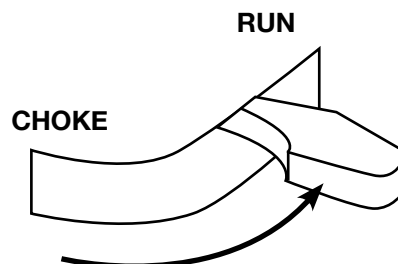

# OPERATION

## STOPPING THE PRESSURE WASHER

### Normal Operation

During normal operation, use the following steps to stop your pressure washer:

1. Lock the spray gun trigger lock in the **OFF** position.
2. Move the engine OFF/ON switch to the **OFF** position.

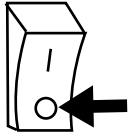

WPX2600/2800  
Switch

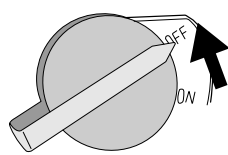

WPX3100  
Switch

3. Close the fuel shutoff valve (WPX3100 Only).
4. Turn the water supply off.
5. Unlock the spray gun trigger and squeeze the trigger to release any pressure in the hoses and pump.
6. Disconnect the garden hose from the water inlet.
7. Complete all steps in *After Each Use* in Maintenance section of manual.

### During an Emergency

If there is an emergency and the pressure washer must be stopped quickly, push the engine control switch to **OFF** position immediately.

### SELECTING NOZZLES

The quick-connect feature allows changing between nozzles while the pressure washer is running once the spray gun trigger is locked in the safe position.

#### NOTICE

Only use the nozzles that were supplied with the pressure washers. Using any other nozzles can affect performance and may void the warranty. For replacement nozzles call (855) 944-3571.

#### WARNING



Always apply the trigger lock to change a nozzle if the engine is running.

High Pressure 0° (**RED**)

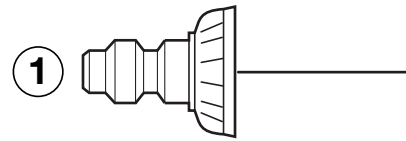

High to Medium Pressure 15° (**YELLOW**)

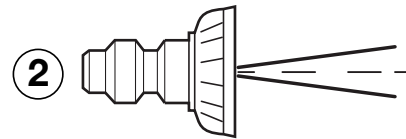

Medium Pressure 25° (**GREEN**)

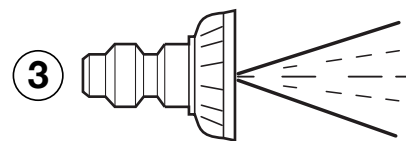

Low Pressure 40° (**WHITE**)

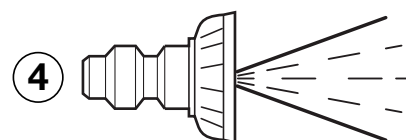

Soap (**BLACK**)

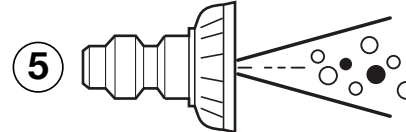

# OPERATION

## NOZZLE APPLICATION

NOZZLE	USE
1. High Pressure Nozzle ( <b>RED</b> ) - higher pressure & smallest spray pattern.  <b>NOTE:</b> The red nozzle can damage surfaces if it is held too close for an extended time.	Use to clean hard, embedded dirt & grime. Use on concrete, brick, driveways, & patios.
2. High to Medium Pressure Nozzle ( <b>YELLOW</b> ) - High to medium pressure with smallest angle spray pattern.	Use to clean paint, stain, mildew, oil, & stuck on dirt & grime. Use on wood, decks, home siding, driveways, & patios.
3. Medium Pressure Nozzle ( <b>GREEN</b> ) - medium pressure & medium spray pattern.	For general rinsing ideal for most all purpose cleaning such as home siding, brick patios, wood decks, driveways and sidewalks, garage floors, etc.
4. Low Pressure Nozzle ( <b>WHITE</b> ) - lower pressure & widest spray pattern.	For delicate rinse for gentle cleaning of cars/trucks, boats, RV's patio furniture, lawn equipment, etc.
5. Soap Nozzle ( <b>BLACK</b> )  <b>NOTE:</b> Only use pressure washer safe soap.	Use to apply soap to cleaning surfaces in order to provide a thorough cleaning.

## CHANGING THE NOZZLE

1. Push up the trigger lock to the **OFF** position.
2. Pull the quick coupler toward the spray gun.
3. Push the nozzle into the coupler and push the coupler away from the spray gun. The nozzle will lock into place. Tug on the nozzle to verify it is locked in place.

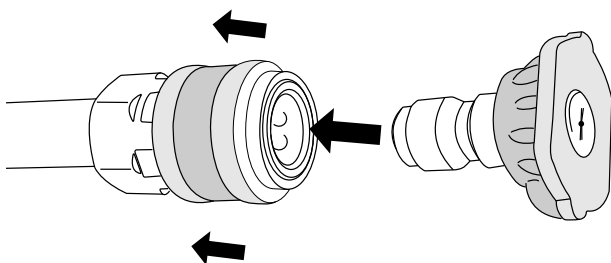

## SPRAYING TIPS

For most cleaning, keep nozzle 8 - 24 in. (20 - 61 cm) away from cleaning surface.

- Damage may occur to the cleaning surface if you spray too close, especially with high-pressure nozzles.
- When beginning to spray, start farther away and move closer to avoid damage to the surface.
- When cleaning tires, allow at least 6 in. (15 cm) between a tire and the nozzle.

### NOTICE

Do not get any closer than 6 in. (15 cm). Spraying closer than 6 in. (15 cm) may damage tire.

To relieve system pressure, shut off engine, turn off water supply and pull gun trigger until water stops flowing.

## SPRAYING SOAP

### NOTICE

Use only pressure washer-safe soap. Use soaps that are designed for pressure washers. Use as recommended by soap manufacturer.

1. Install the soap nozzle (**BLACK**).

### NOTICE

Only use the soap nozzle to apply soap. Using other nozzles will not apply soap. NEVER use caustic liquid with pressure washers. Do not route soap siphon hose where it can contact the muffler while engine is running.

2. Prepare soap solution following manufacturer's instructions.
3. Place soap siphon hose into soap container.
4. Make sure the garden hose and high-pressure hose are connected.

### NOTICE

All hoses must be connected before starting the engine.



5. Turn on the water supply.
6. Start the engine and squeeze the trigger.
7. Use long, even overlapping stroke to apply soap.
8. Allow 3 - 5 minutes for the soap to soak in before rinsing. Do not allow the soap to dry on the surface before rinsing. Reapply soap if necessary to maintain a wet surface for the soap to soak in.

### NOTICE

Clean the soap siphon hose once done.

# OPERATION

## RINSING

 <b>WARNING</b>	
	Always apply the trigger lock to change a nozzle if the engine is running

1. Select the desired nozzle and change nozzle.
2. Squeeze the trigger and carefully start to spray, keeping nozzle at a safe distance from the cleaning surface.
3. Starting from the top of the surface, spray a small area then check surface for damage. If no damage, continue rinsing by using overlapping strokes working down the surface. Keep checking surface for damage while rinsing.

## CLEANING SOAP SIPHON HOSE

If used, clean the soap siphon hose before stopping the engine.





1. If necessary, install the soap nozzle (**BLACK**).
2. Use clean water to flush the soap siphon hose. Submerge the soap siphon hose in clean water.
3. Flush the soap siphon hose for 1 - 2 minutes while the engine is running.
4. Once clean, stop the engine.
5. Point spray gun in a safe direction. Squeeze the trigger to release pressure within the system.



# MAINTENANCE



## MAINTENANCE



**BEFORE ASSEMBLING THE PRESSURE WASHER REVIEW THE SAFETY SECTION STARTING ON PAGE 5.**

 <b>WARNING</b>	
	Avoid accidentally starting the pressure washer during maintenance by removing the spark plug boot from the spark plug.
	Allow hot components to cool to the touch prior to performing any maintenance procedure.
	Internal pressure can build in the engine crankcase while the engine is running. Removing the oil fill plug/dipstick while the engine is hot can cause extremely hot oil to spray out of the crankcase and can severely burn skin. Allow engine oil to cool for several minutes before removing the oil fill plug/dipstick.
	Always perform maintenance in a well ventilated area. Gasoline fuel and fuel vapors are extremely flammable and can ignite under certain conditions.

 <b>CAUTION</b>	
	Avoid skin contact with engine oil or gasoline. Prolonged skin contact with engine oil or gasoline can be harmful. Frequent and prolonged contact with engine oil may cause skin cancer. Take protective measures and wear protective clothing and equipment. Wash all exposed skin with soap and water.

 <b>WARNING</b>	
	Failure to perform periodic maintenance or not following maintenance procedures can cause the pressure washer to malfunction and could result in death or serious injury.

<b>NOTICE</b>	
Periodic maintenance intervals vary depending on pressure washer operating conditions. Operating the pressure washer under severe conditions, such as sustained high-load, high-temperature, or unusually wet or dusty environments, will require more frequent periodic maintenance. The intervals listed in the maintenance schedule should be treated only as a general guideline.	

# MAINTENANCE

**TABLE 1: MAINTENANCE SCHEDULE - OWNER PERFORMED**

Maintenance Item	Before Every Use	After First 5 Hours	After 25 Hours of Use or Every Year	After 50 Hours of Use or Every Year	After 100 Hours of Use or Every Year
Engine Oil	Check Level	Change	-	Change	-
Cooling Features	Check	-	-	-	Clean
Air Filter	Check	-	Check	Replace*	-
Spark Plug	-	-	-	Check/Clean	Replace
Spark Arrestor	Inspect	-	-	Clean	-
Water Inlet Screen	Inspect	-	-	Replace	-

\*Service more frequently if operating in dry and dusty conditions

**TABLE 2: MAINTENANCE SCHEDULE - AUTHORIZED WESTINGHOUSE SERVICE DEALER PERFORMED**

Maintenance Item	Before Every Use	After First 5 Hours	After 25 Hours of Use or Every Year	After 50 Hours of Use or Every Year	After 100 Hours of Use or Every Year
Valve Clearance	-	-	-	-	Check/Adjust
Fuel Filter	Check	-	-	Replace	-
Combustion Chamber	-	-	-	-	Decarbonize

## ENGINE OIL MAINTENANCE

1. Only use the engine oil specified below.

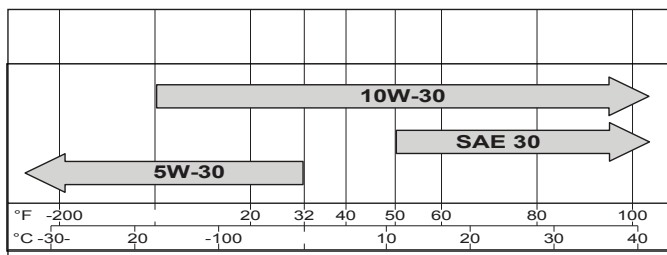

2. Only use 4-stroke/cycle engine oil. NEVER USE 2-STROKE/CYCLE OIL.

### NOTICE

Always maintain proper engine oil level. Failure to maintain proper engine oil level could result in severe damage to the engine and/or shorten the life of the engine.

Always use the specified engine oil. Failure to use the specified engine oil can cause accelerated wear and/or shorten the life of the engine.

## CHECKING ENGINE OIL

1. Always operate or maintain the pressure washer on a flat surface.
2. Stop engine if running.
3. Let engine sit and cool for several minutes (allow crankcase pressure to equalize).
4. With a damp rag, clean around the oil fill plug/dipstick.
5. Remove oil fill plug/dipstick and wipe it clean.
6. Thread the oil fill plug/dipstick all the way back in and then remove and check the oil level on the oil fill plug/dipstick.
  - **Acceptable Oil Level** – Oil is visible on the crosshatches between the H and L lines on the oil fill plug/dipstick.
  - **Low Oil** – Oil is below the L line on the oil fill plug/ dipstick.

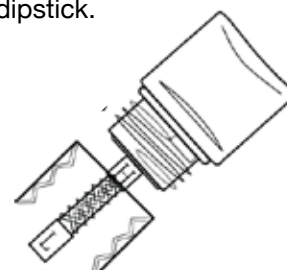

# MAINTENANCE

## ADDING ENGINE OIL

### NOTICE

Oil crankcase capacity is 0.4L on WPX2600 and 0.6L for WPX2800/3100. Do not overfill.

1. Always operate or maintain the pressure washer on a flat surface.
2. Stop engine if running.
3. Let engine sit and cool for several minutes (allow crankcase pressure to equalize).
4. Thoroughly clean around the oil fill plug/dipstick.
5. Remove oil fill plug/dipstick and wipe clean.
6. See *Engine Oil Specification in Engine Oil Maintenance Section* for the proper engine oil.
7. Using the funnel provided, slowly add engine oil to the engine. Stop frequently to check the level to avoid overfilling.
8. Continue to add oil until the oil is at the correct level.

## CHANGING ENGINE OIL

1. Stop the engine. Ensure gas cap is properly sealed.
2. Let engine sit and cool for several minutes (allow crankcase pressure to equalize and hot surfaces to cool down).
3. Place oil pan (or suitable container) beside the oil fill plug/dipstick.
4. Remove the oil drain plug so the oil can drain.
5. With a clean rag, thoroughly clean around the oil filler cap. Allow oil to completely drain.
6. Fill crankcase with oil following the steps outlined in *Adding Engine Oil*.
7. Dispose of used engine oil properly.

### NOTICE

Never dispose of used engine oil by dumping the oil into a sewer, on the ground, or into ground water or waterways. Always be environmentally responsible. Follow the guidelines of the EPA or other governmental agencies for proper disposal of hazardous materials. Consult local authorities or reclamation facility.

## AIR FILTER MAINTENANCE

### WARNING



Never use gasoline or other flammable solvents to clean air filter. Use only household detergent soap to clean the air filter.

The air filter must be replaced after every 50 hours of use or every year (frequency should be increased if pressure washer is operated in a dusty environment).

**NOTE:** *The air filter cannot be cleaned with compressed air.*

1. Turn off the pressure washer and let it cool for several minutes if running.
2. Move the pressure washer to a flat, level surface.
3. Loosen the clip or nut holding the cover in place and open the air cleaner cover.

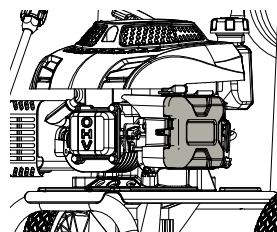

WPX2600/2800 Clip On Air Filter Cover

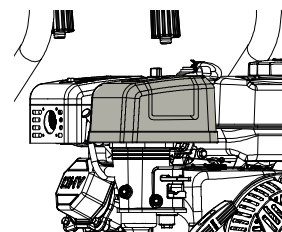

WPX3100 Bolt on Air Filter Cover

4. Remove the foam air filter element. (WPX3100 will have an additional paper filter that must only be cleaned with compressed air or brush).

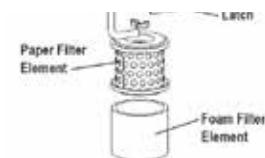

WPX3100 Air Filter Assembly

5. Wash the foam air filter elements by submerging the elements in a solution of household detergent soap and warm water. Slowly squeeze the foam to thoroughly clean.
7. Dispose of used soap cleaning solution properly.
8. Dry the air filter elements by again applying a slow firm squeezing action.
9. Once the air filters are dry, coat the air filters with clean engine oil (see Figure 22 below).
10. Squeeze the filters to remove any excess oil.
11. Insert the new air filter element in the air cleaner assembly box. (WPX3100 make sure to install paper filter correctly as well).
12. Close the air cleaner cover and secure cover.

# MAINTENANCE

## SPARK PLUG MAINTENANCE

The spark plug must be replaced after every 100 hours of use or every year.

1. Stop the pressure washer and let it cool for several minutes if running.
2. Move the pressure washer to a flat, level surface.
3. Remove the spark plug boot by firmly pulling the plastic spark plug boot handle directly away from the engine.

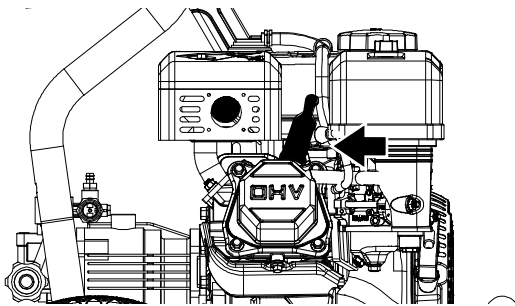

4. Clean the area around the spark plug.
5. Remove the spark plug from the cylinder head.
6. Place a clean rag over the opening created by the removal of the spark plug to make sure no dirt can get into the chamber.
7. Inspect the spark plug for:
  - Cracked or chipped insulator
  - Excessive wear
  - Spark plug gap (the correct valve is 0.030 in. [0.76 mm]).
8. Install the spark plug by carefully following the steps outlined below:
  - A. Carefully insert the spark plug back into the cylinder head. Hand-thread the spark plug until it bottoms out.
  - B. Turn the spark plug to ensure it is fully seated. Torque plug to 20 ft-lb (27 N.m).
  - C. Replace the spark plug boot, making sure the boot fully engages the spark plug's tip.

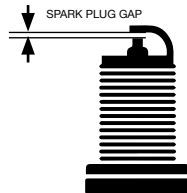

## PRESSURE WASHER COMPONENTS

### Water Filter Screen

1. Remove the water inlet hose.
2. Remove the cone-shaped water filter screen from the water inlet hose fitting.
3. Inspect the water filter screen for debris or damage.
4. If the water filter screen is clogged or full of debris, clean it by flushing it with water on both sides. If it is damaged, replace it.
5. Reinsert the water filter screen into the water inlet hose fitting. The cone side must face out.

### High-Pressure Hose

1. Remove the high-pressure hose.
2. Inspect the O-rings on the hose fitting. Replace if cracked or split.
3. Inspect the high-pressure hose for leaks or damage.
4. Replace the high-pressure hose if it leaks or damage are present.

### Spray Gun

1. Inspect the O-ring on the wand where it connects to the spray gun. Replace if cracked or split.
2. Inspect the connection between the hose and the spray gun. Ensure that the hose is connected tightly to the fitting on the spray gun.
3. Release the trigger lock by slightly pushing the trigger forward.
4. Test the trigger by pulling it backward. Make sure that the trigger returns to its original position when it is released.

### Soap Siphon Hose

1. Remove the soap siphon hose from the soap container.
2. Inspect the soap siphon hose. Clean it if it is clogged.
3. Inspect the soap siphon hose for leaks or damage.
4. Replace soap siphon hose if it is damaged.

### Nozzle and Lance



1. Shut off the pressure washer and turn off the water supply.
2. Pull the trigger of the spray gun to release any remaining water pressure.
3. Lock spray gun trigger.
4. Remove the nozzle tip from the end of the spray gun lance.
5. Flush the nozzle tip with clean water. Use cleaning tool provided to remove any obstructions inside the nozzle hole.
6. Remove the lance extension from the spray gun.
7. Flush clean water through the lance extension.
8. Reconnect the lance extension to the spray gun.
9. Reinstall the nozzle tip into the lance extension.

# MAINTENANCE

## AFTER EACH USE

1. Shut off the pressure washer and turn off the water supply.
2. Remove the soap siphon hose from the soap container and insert it into a container with clean water.
3. Install black soap nozzle on spray gun. Turn on the water supply and start the pressure washer.
4. Pull the spray gun trigger and spray for 1 - 2 minutes. This will ensure that all remaining soap is flushed from the pump.
5. Shut off the pressure washer and turn off the water supply.
6. Pull the spray gun trigger to release any remaining pressure.
7. Let the pressure washer cool down.
8. Disconnect the high-pressure hose and water inlet hose.
9. Drain the hoses, spray gun and nozzle extension.
10. Engage the trigger lock on the spray gun.
11. Wipe off all remaining water with a clean, dry rag.
12. While the pressure washer is turned off, pull the recoil handle 5 - 6 times. This should remove most of the remaining liquid inside the pump.
13. Store the pressure washer in a clean, dry place.

## LONG-TERM STORAGE

 <b>WARNING</b>	
	Never store a pressure washer with fuel in the tank indoors or in a poorly ventilated area where the fumes can come in contact with an ignition source such as a: 1) pilot light of a stove, water heater, clothes dryer or any other gas appliance; or 2) spark from an electric appliance.

<b>NOTICE</b>
Gasoline stored for as little as 60 days can go bad, causing gum, varnish and corrosive buildup in fuel lines, fuel passages and the engine. The corrosive buildup restricts the flow of fuel, preventing an engine from starting after a prolonged storage period.

Proper care should be taken to prepare the pressure washer for any long-term storage.

## Storage Procedure for 1 - 3 Months

1. Clean the pressure washer as outlined *After Each Use* on page 21.
2. Add a gasoline fuel stabilizer to the fuel tank. Follow the recommended procedure of the fuel stabilizer manufacturer for correct amount of stabilizer to add.

## Storage Procedure for Greater Than 3 Months

1. Clean the pressure washer as outlined *After Each Use*.
2. Drain all gasoline from the fuel tank as best as possible.
3. Connect a hose to the water inlet fitting and turn on the hose.
4. Start the engine and allow pressure washer to run until all the remaining gasoline in the fuel lines and carburetor is consumed and the engine shuts off.
5. Clean the pressure washer as outlined in *After Each Use*.
6. Change the oil (see *Changing Oil*).
7. Remove the spark plug (see *Spark Plug Maintenance*) and place about 1 tablespoon of oil in the spark plug opening. While placing a clean rag over the spark plug opening, slowly pull the recoil handle to allow the engine to turn over several times. This will distribute the oil and protect the cylinder wall from corroding during storage.
8. Replace the spark plug (see *Spark Plug Maintenance*).
9. Move the pressure washer to a clean, dry place for storage.

## WINTER STORAGE

1. Follow steps 1 - 11 in *After Each Use*.
2. Store the hoses, spray gun and nozzle extension.
3. Disconnect the spark plug wire.
4. Connect a 3ft (1m) section of garden hose to the water inlet hose fitting.
5. Using a funnel, pour 6 oz (177 mL) of RV antifreeze into the hose

<b>NOTICE</b>
Use only RV antifreeze. Any other antifreeze can damage the pump.

6. Slowly pull the recoil handle several times, until antifreeze comes out of the high-pressure fitting of the pump.
7. Remove the 3ft (1m) garden hose.
8. Reconnect the spark plug wire.
9. Store the pressure washer in a clean, dry place.

# MAINTENANCE

## REMOVE AND INSTALL THE PUMP

1. Disconnect high-pressure hose and soap siphon hose from pump.

**NOTE:** *The pump mounting bolts also mount the engine in place. Do not tip the unit or the engine could be damaged when pump is removed.*

2. Remove the mounting bolts and washers holding the pump to the frame.

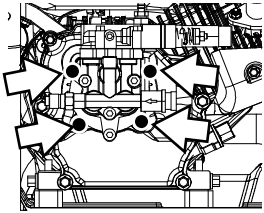

WPX3100 Pump  
(Back View)

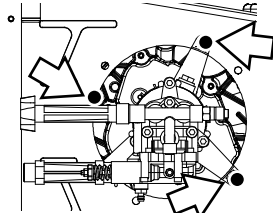

WPX2600/2800 Pump  
(Bottom View)

3. Slide the pump down off the crankshaft.
4. Apply a thin layer of grease to the crankshaft before installing the pump.
5. Inspect the key and keyway on crankshaft.



6. Slide the pump onto the crankshaft making sure the key lines with the keyway in the pump.
7. Install the pump/engine mounting bolts and tighten to 25 ft-lb (34 N.m).

## ⚠ WARNING



Allow hot components to cool to the touch prior to performing any maintenance procedure.

## INSPECT MUFFLER

Inspect the muffler for cracks, corrosion, or other damage. If replacement parts are required, make sure to use only original equipment replacement parts.

## CLEANING SPARK ARRESTOR

1. Remove heat shield from the muffler by loosening the two bolts.

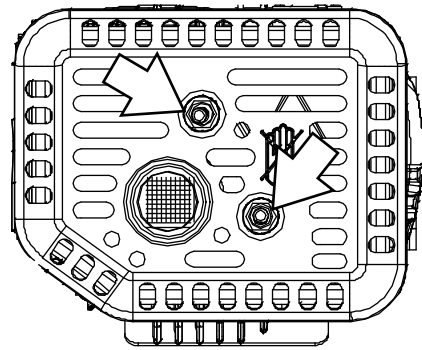

WPX2800 Muffler Shown

2. If the spark arrestor is removable, take it off the muffler. If it is welded then simply clean it on the muffler.
3. Inspect the spark arrestor, replace if torn, perforated or otherwise damaged. Do not use a defective screen.
4. Use a wire brush to clear carbon from spark arrestor. If required use a commercial solvent to clean.

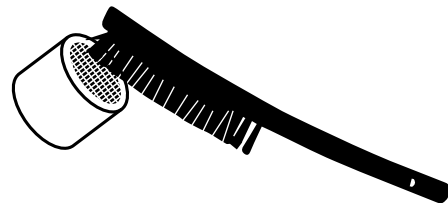

5. Reinstall muffler assembly.

# TROUBLESHOOTING

## ⚠ WARNING



Before attempting to service or troubleshoot the pressure washer, the owner or service technician must first read the owner's manual and understand and follow all safety instructions. Failure to follow all instructions may result in conditions that can lead to voiding of the EPA certification or product warranty, serious personal injury, property damage or even death.

PROBLEM	POTENTIAL CAUSE	SOLUTION
Engine will not start.	Fuel shutoff valve (if equipped) is in the OFF position.	Move the fuel shutoff valve (if equipped) to the ON position.
	Pressure washer is out of fuel.	Add fuel to the pressure washer.
	Fuel flow is obstructed.	Inspect and clean fuel delivery passages.
	Unit is not properly primed.	Push primer bulb three times.
	Air filter is dirty	Check and clean the air filter
	Oil level is low.	Check oil level and add oil if necessary
	Spark plug boot is not fully engaged with the spark plug tip.	Firmly push down on the spark plug to ensure the boot is fully engaged.
	Spark plug is faulty.	Remove and check the spark plug. Replace if faulty.
	Fuel is stale.	Drain fuel and replace with fresh fuel.
	Water in fuel.	Drain fuel and replace with fresh fuel.
	If trying 1-10 above does not solve the problem, the cause might be that the pressure washer has a fault.	Take the pressure washer to your nearest authorized service dealer.
Engine suddenly stops running.	Pressure washer is out of fuel.	Check fuel level. Add fuel if necessary
	Oil level is low.	Check oil level. Add oil if necessary.
	If trying 1-2 above does not solve the problem, the cause might be that the pressure washer has a fault.	Take the pressure washer to your nearest authorized service dealer.
Engine runs erratic; does not hold a steady RPM.	Choke lever (if equipped) was left in the ON position.	Move choke lever (if equipped) to the OFF position.
	Air filter is dirty.	Check and clean the air filter.
	If trying 1-2 above does not solve the problem, the cause might be that the pressure washer has a fault.	Take the pressure washer to your nearest authorized service dealer.
No or low pressure.	Water supply is low.	Increase the water supply.
	Nozzle is obstructed.	Clean the nozzle.
	Water filter screen is obstructed.	Remove and clean the filter.
	Water inlet is obstructed.	Clear the inlet.
	Inlet hose is kinked or leaks.	Straighten the inlet hose and repair leaks
	High-pressure hose is obstructed or leaks.	Clear obstructions in the hose or replace the hose.
	High-pressure hose fitting leaks.	Tighten the fitting. Apply sealant tape if necessary.
	If trying 1-7 above does not solve the problem, the cause might be that the pressure washer has a fault.	Take the pressure washer to your nearest authorized service dealer.
Soap does not mix with water spray.	Soap siphon hose is not connected properly.	Insert the soap siphon hose properly into the soap container.
	Soap siphon hose is obstructed.	Clear obstructions in the soap siphon hose.

**This page was intentionally left blank**

# WPX2600 EXPLODED VIEW

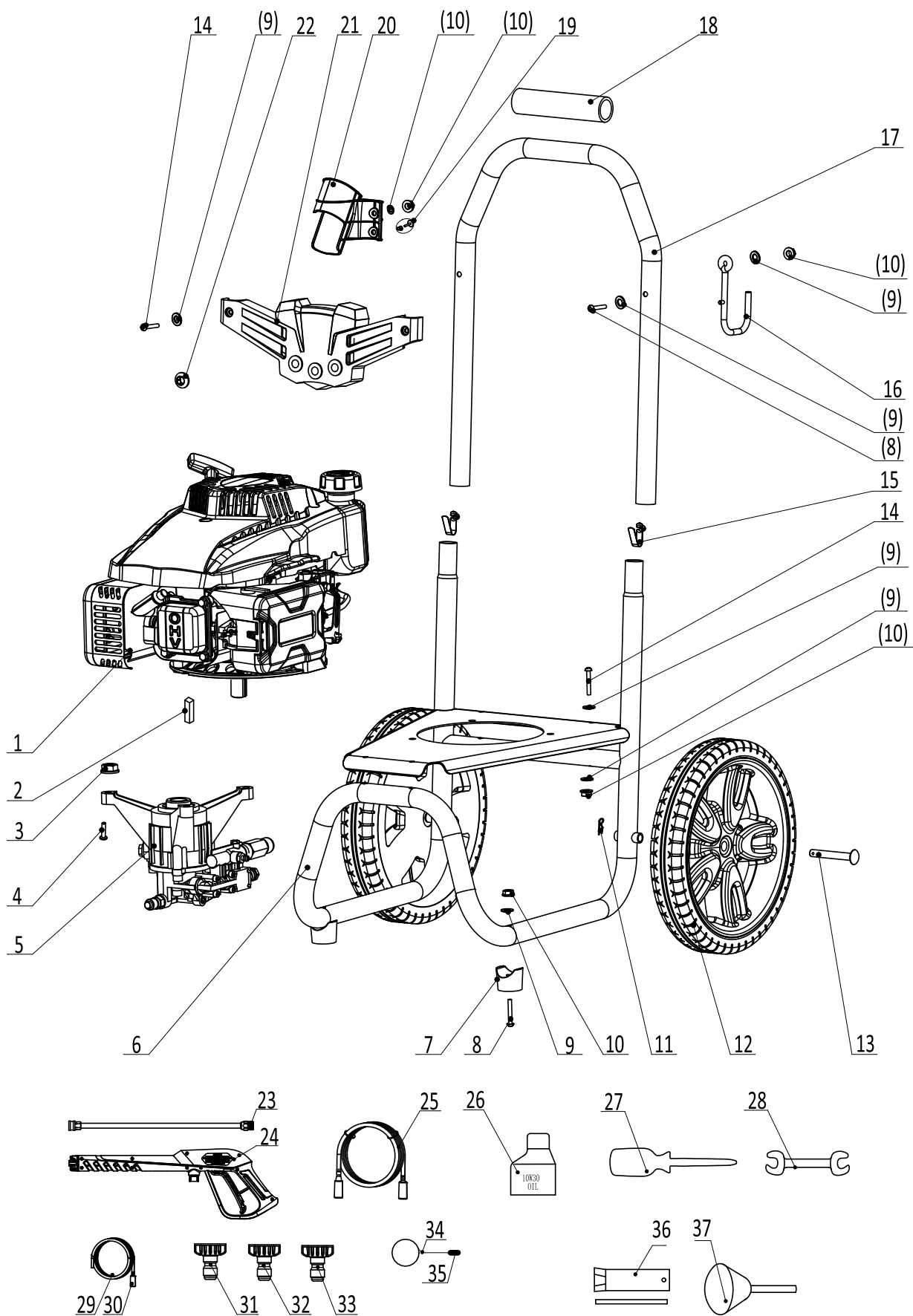

# WPX2600 EXPLODED PART NUMBERS

NO.	PART.	DESCRIPTION
1	300000	ENGINE ASSY
2	300001	FLAT KEY 4.78 X 5 X 35
3	-	LOCK NUT M8
4	-	BOLT M8X45
5	300003	WATER PUMP ASSEMBLY
6	300004	FRAME BASE
7	300005	FOOT, FRAME ISOLATING
8	-	HEXAGON SOCKET BUTTON HEAD SCREWS M6X40
9	-	FLAT WASHER Ø6
10	-	LOCK NUT M6
11	300008	HAIR PIN
12	300009	WHEEL
13	300010	AXLE
14	-	HEXAGON SOCKET BUTTON HEAD SCREWS M6X45
15	300012	DETENT SPRING
16	300013	HOOK, HIGH PRESSURE HOSE
17	300014	HANDLE, FRAME
18	300015	FOAM GRIP

NO.	PART.	DESCRIPTION
19	-	PLASTIC RIVETS
20	300017	HOOK,GUN
21	300018	PANEL
22	300019	NOZZLE HOLDER
23	300270	SPRAY GUN
24	300269	WAND
25	300022	HIGH PRESSURE HOSE
26	300023	OIL BOTTLE
27	-	SCREWDRIVER
28	-	WRENCH
29	300026	SIPHON TUBE
30	300027	DRAIN FILTER ASSY
31	300137	NOZZLE 0°
32	300211	NOZZLE 25°
33	300030	SOAP NOZZLE
34	300031	NOZZLE CLEANER
35	300032	SHEATH, NOZZLE CLEANER
36	-	SPARK PLUG SLEEVE.
37	-	FUNNEL

Parts with no number are not stocked by the manufacturer. Please call our service team if you have questions.

# WPX2600 ENGINE VIEW

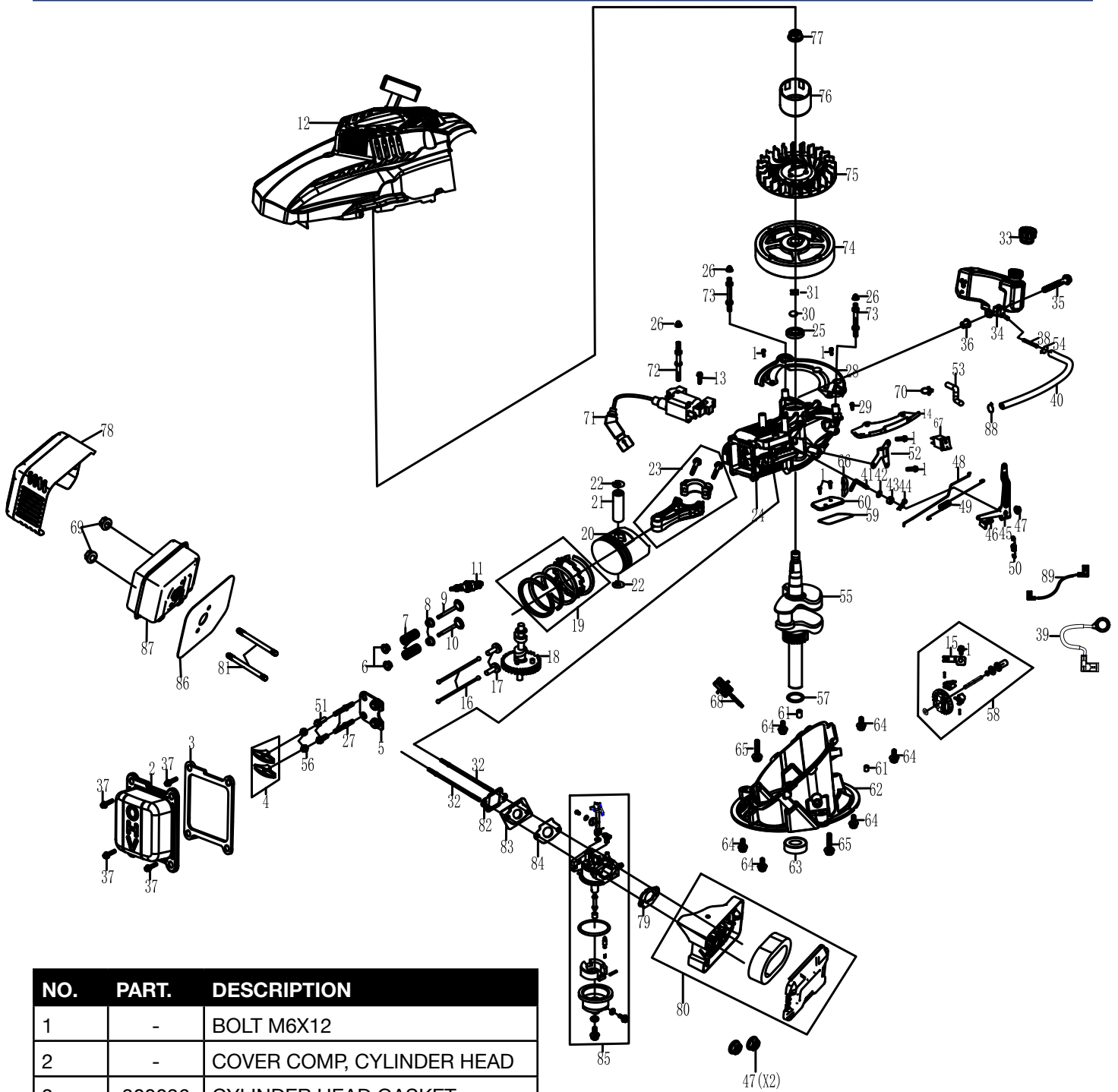

NO.	PART.	DESCRIPTION
1	-	BOLT M6X12
2	-	COVER COMP, CYLINDER HEAD
3	300036	CYLINDER HEAD GASKET
4	180872	ARM, ROCKER
5	300037	PLATE, PUSH ROD GUIDE
6	300038	SEAT, VALVE SPRING,IN
7	300039	SPRING, VALVE
8	300040	RETURNER, INTAKE VALVE
9	300041	VALVE, INTAKE
10	300042	VALVE EXHAUST
11	-	SPARK PULG
12	300043	COVER, RECOIL

NO.	PART.	DESCRIPTION
13	-	BOLT M6X25
14	-	WIND SHIELD, LH
15	-	PLATE, GOVERNOR
16	300047	ROD, PUSH
17	300048	LIFTER, VALVE
18	300049	CAMSHAFT ASSY
19	300050	SCRAPER RING SET, PISTON
20	300051	PISTON

# WPX2600 ENGINE PART NUMBERS

NO.	PART.	DESCRIPTION
21	300052	PIN, PISTON
22	300053	CLIP, PISTON
23	300054	ROD ASSEMBLY.
24	300055	CYLINDER
25	300056	TOP OIL SEAL
26	-	NUT, FLANGE
27	300058	ADJUSTER ROCKER ARM
28	-	SHROUD
29	-	BOLT M6X10
30	-	BREATHER VALVE COVER
31	-	BREATHER VALVE SPRING
32	-	BOLT, STUD
33	300064	FUEL TANK CAP
34	300065	FUEL TANK
35	-	BOLT M6X38
36	-	BUSHING, FUEL TANK
37	-	BOLT M6X16
38	300067	FUEL FILTER
39	300068	FLAMEOUT WIRE
40	300069	FUEL LINE
41	-	SHAFT, GOVERNOR ARM
42	-	WASHER, GOVERNOR ARM SHAFT
43	-	SEAL, GOVERNOR ARM SHAFT
44	-	PIN, LOCK
45	-	GOVERNOR ARM
46	-	BOLT, GOVERNOR ARM M6X21
47	-	NUT M6
48	300076	ROD, GOVERNOR
49	300077	SPRING, THROTTLE RETURN
50	300078	SPRING, GOVERNOR
51	-	NUT
52	-	SHROUD ASSY, UPPER
53	-	TUBE, BREATHER
54	-	CLIP, FUEL LINE
55	300083	CRANKSHAFT ASSY
56	300084	ROCKER ARM NUT

NO.	PART.	DESCRIPTION
57	-	WASHER, CRANKSHAFT
58	300086	GOVERNOR ASSEMBLY
59	300087	GASKET, BREATHER CHAMBER
60	300088	CAP, BREATHER CHAMBER
61	300089	DOWEL PIN, CASECOVER
62	300090	COVER ASSEMBLY, CRANKCASE
63	300091	BOTTOM OIL SEAL
64	-	BOLT M6X18
65	-	BOLT M6X45
66	300094	FILTER, BREATHER
67	300095	SWITCH ASSEMBLY
68	300096	DIPSTICK
69	-	NUT LOCK
70	-	CLIP
71	300099	IGNITION COIL ASSY
72	-	BOLT STUD, IGNITION COIL
73	-	BOLT STUD, RECOIL STARTER
74	300102	FLYWHEEL ASSEMBLY
75	-	RECOIL STARTER FAN
76	-	PULLEY, STARTER
77	-	NUT M14
78	-	SHIELD, MUFFLER
79	-	AIR CLEANER GASKET
80	300107	AIR CLEANER ASSEMBLY
81	-	BOLT, STUD
82	300109	INTAKE GASKET
83	300110	CARBURETOR INSULATOR
84	300111	CARBURETOR GASKET
85	300112	CARBURETOR ASSY
86	300113	EXHAUST GASKET
87	300114	MUFFLER ASSY
88	-	CLIP, FUEL LINE
89	300116	FLAMEOUT WIRE

Parts with no number are not stocked by the manufacturer. Please call our service team if you have questions.

# WPX2800 EXPLODED VIEW

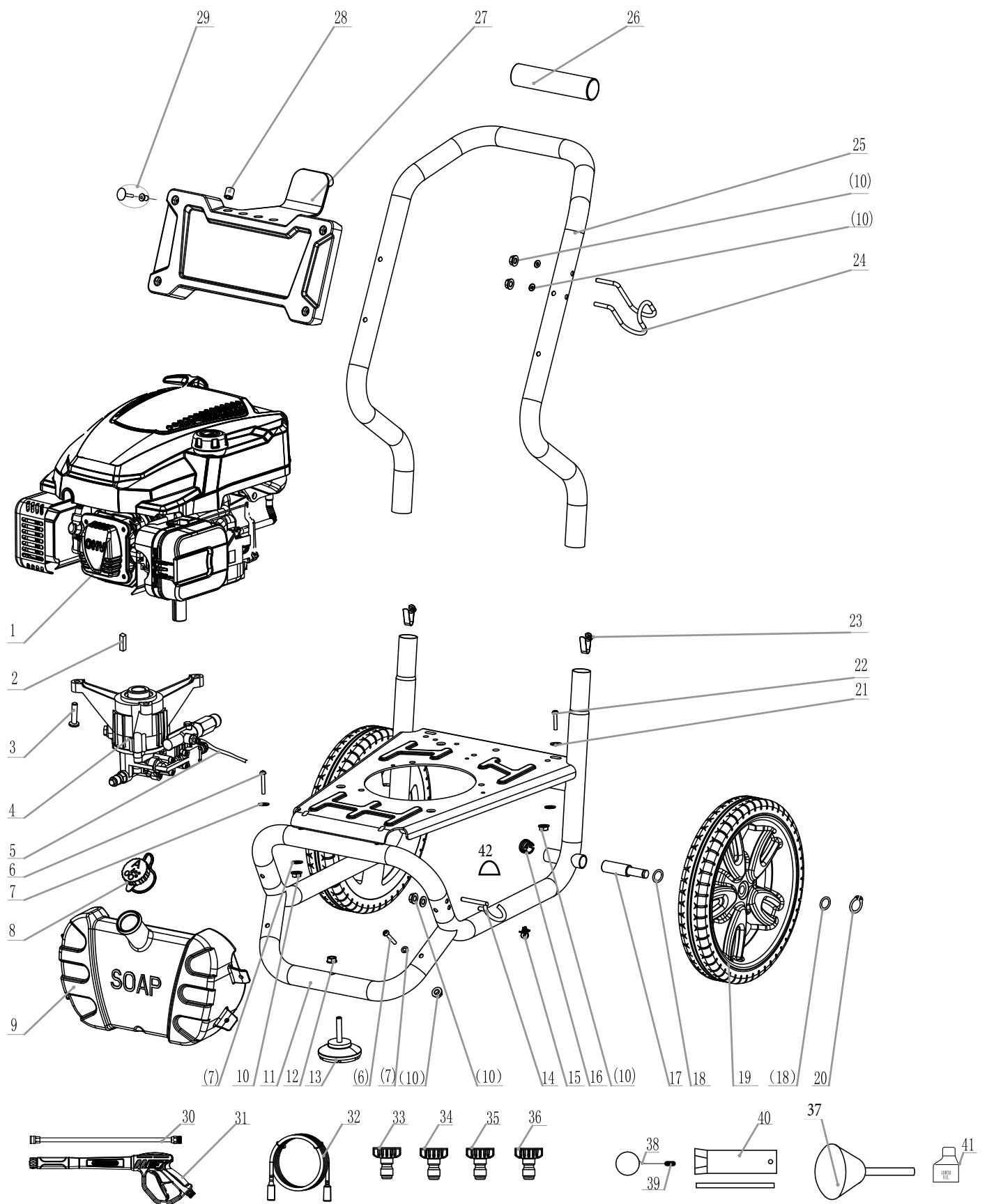

# WPX2800 EXPLODED PART NUMBERS

NO.	PART.	DESCRIPTION
1	300117	ENGINE
2	300001	FLAT KEY
3	-	BOLT M8*45
4	300118	WATER PUMP
5	300119	LIQUID SUCTION HOSE
6	-	BOLT M6*45
7	-	FLAT MAT Ø6
8	300120	SOAP TANK CAP
9	300121	SOAP TANK
10	-	LOCK NUT M6
11	300122	FRAME BASE
12	-	LOCK NUT M8
13	300123	FOOT, FRAME ISOLATING
14	300124	GUN BRACKET
15	-	CLIP
16	-	PUSH ROD PLUG
17	300126	WHEEL AXLE
18	-	FLAT MAT Ø14*Ø20*1.5
19	300009	WHEEL
20	300128	WHEEL LOCK
21	-	BOLT M6*35

NO.	PART.	DESCRIPTION
22	-	GASKET Ø6.4 X Ø18 X 1.6
23	-	DETENT SPRING
24	300131	UPPER GUN HOOK
25	300132	HANDLE, FRAME
26	300133	FOAM GRIP
27	300134	PANEL
28	300019	NOZZLE SET
29	300016	PLASTIC RIVETS
30	300135	SPRAY GUN
31	300136	WAND
32	300022	HIGH PRESSURE HOSE
33	300137	NOZZLE 0°
34	300210	NOZZLE 15°
35	300139	NOZZLE 40°
36	300030	SOAP NOZZLE
37	-	FUNNEL
38	-	NOZZLE CLEANER
39	-	SHEATH, NOZZLE CLEANER
40	-	SPARK PLUG SLEEVE.
41	-	OIL BOTTLE
42	-	RUBBER SLEEVE

Parts with no number are not stocked by the manufacturer. Please call our service team if you have questions.

# WPX2800 ENGINE VIEW

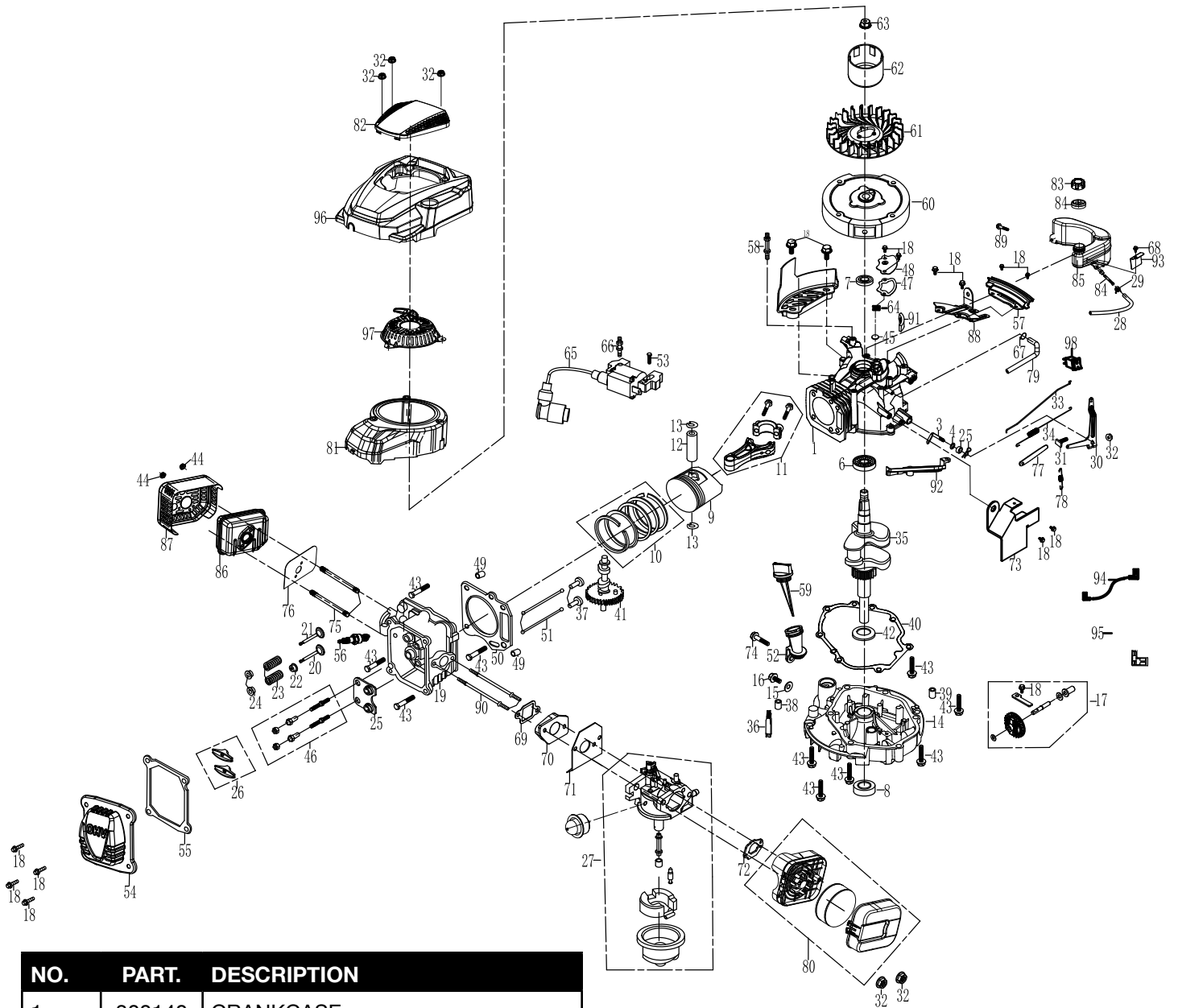

NO.	PART.	DESCRIPTION
1	300140	CRANKCASE
2	-	SEAL, GOVERNOR ARM SHAFT
3	-	SHAFT, GOVERNOR ARM
4	-	WASHER, GOVERNOR ARM SHAFT
5	-	PIN, LOCK
6	180556	BALL BEARING
7	300142	TOP OIL SEAL
8	300143	BOTTOM OIL SEAL
9	300144	PISTON
10	300145	SCRAPER RING SET, PISTON
11	300146	ROD ASSEMBLY., CONNECTING
12	-	PIN, PISTON

NO.	PART.	DESCRIPTION
13	-	CLIP, PISTON
14	300147	COVER ASSEMBLY, CRANKCASE
15	180544	WASHER, DRAIN PLUG
16	-	BOLT DRAIN PLUG
17	300148	GOVERNOR ASSEMBLY
18	-	BOLT M6X12
19	300149	CYLINDER HEAD
20	300150	VALVE, IN
21	300151	VALVE EXHAUST

# WPX2800 ENGINE PART NUMBERS

NO.	PART.	DESCRIPTION
22	300152	RETURNER, INTAKE VALVE
23	180866	SPRING, VALVE
24	180867	SEAT, VALVE SPRING, IN
25	300153	PLATE, PUSH ROD GUIDE
26	300154	ROCKER ASSY
27	300155	CARBURETOR ASSEMBLY
28	300156	FUEL LINE
29	-	CLIP, FUEL LINE
30	-	GOVERNOR ARM
31	-	BOLT, GOVERNOR ARM M6X21
32	-	NUT M6
33	300158	ROD, GOVERNOR
34	300159	SPRING, THROTTLE RETURN
35	300160	CRANKSHAFT ASSEMBLY
36	-	PIPE, OIL DEFENSE
37	300162	LIFTER, VALVE
38	-	DOWEL PIN, CASECOVER
39	-	DOWEL PIN, CASECOVER
40	300165	CASECOVER GASKET
41	300166	CAMSHAFT ASSEMBLY
42	300085	WASHER, CRANKSHAFT
43	-	BOLT M8X50
44	-	NUT M6
45	-	COVER, BREATHER VALVE
46	-	ROCKER ARM TIGHTENING BOLTS
47	300168	BREATHER CHAMBER GASKET
48	-	CAP, BREATHER CHAMBER
49	-	PIN, DOWEL
50	300170	CYLINDER HEAD GASKET
51	300171	PUSH ROD
52	300172	OIL FILLER EXTENSION
53	-	BOLT M6X30
54	-	COVER COMP, CYLINDER HEAD
55	300175	HEADCOVER GASKET
56	180526	SPARK PLUG
57	-	SHROUD
58	-	BOLT STUD, RECOIL STARTER
59	300178	DIPSTICK

NO.	PART.	DESCRIPTION
60	-	FLYWHEEL ASSEMBLY
61	-	FAN, RECOIL STARTER
62	-	PULLEY, STARTER
63	-	NUT M14
64	-	BREATHER VALVE SPRING
65	300181	IGNITION COIL ASSY
66	-	BOLT STUD, IGNITION COIL
67	-	CLIP, FUEL LINE
68	-	BOLT M4X8
69	300184	PACKING, INTAKE
70	-	INSULATOR, CARBURETOR
71	300186	CARBURETOR GASKET
72	300106	AIR CLEANER GASKET
73	-	SHROUD ASSY, UPPER
74	-	BOLT M8X20
75	-	BOLT, STUD
76	300189	EXHAUST GASKET
77	-	CLIP, WIRE HARNESS
78	300190	SPRING, GOVERNOR
79	-	TUBE, BREATHER
80	300192	AIR CLEANER ASSEMBLY
81	300193	HOOD, FAN
82	300194	STARTER COMP, RECOIL
83	300064	FUEL TANK CAP COMP
84	300067	FUEL FILTER
85	300195	FUEL TANK ASSEMBLY
86	300114	MUFFLER ASSY
87	-	SHIELD, OUT MUFFLER
88	-	FUEL TANK PLATE
89	-	DISC BOLT M6X20
90	-	STUD
91	-	METAL SCREEN
92	-	WIND DEFLECTOR C
93	-	WIND DEFLECTOR
94	300200	FLAMEOUT WIRE
95	300201	OFF LINE
96	300202	IN THE HOOD
97	300203	RECOIL STARTER
98	300095	SWITCH ASSEMBLY



# WPX3100 EXPLODED PART NUMBERS

NO.	PART.	DESCRIPTION
1	300204	ENGINE
2	300120	SOAP TANK CAP
3	300121	SOAP TANK
4	300205	FRAME BASE
5	-	LOCK NUT M8
6	300123	FOOT, FRAME ISOLATING
7	-	BOLT M6*45
8	-	FLAT MAT Ø6
9	-	LOCK NUT M6
10	300123	BRACKET, DOWN,GUN
11	-	CLIP
12	300126	WHEEL AXLE
13	-	FLAT MAT Ø14*Φ20*1.5
14	300009	WHEEL
15	300128	SHAFT CARD
16	300206	ENGINE MOUNT, VIBRATION ISOLATOR
17	-	NUT M8
18	300012	DETENT SPRING
19	300132	HANDLE, FRAME
20	300131	UPPER GUN HOOK
21	300133	FOAM GRIP
22	300207	PANEL

NO.	PART.	DESCRIPTION
23	300019	NOZZLE SET
24	300016	PLASTIC RIVETS
25	300026	LIQUID SUCTION HOSE
26	300208	WATER PUMP
27	300001	FLAT KEY
28	-	BOLT M8×20
29	300136	WAND
30	300135	SPRAY GUN
31	300209	HIGH PRESSURE HOSE
32	300137	NOZZLE 0°
33	300210	NOZZLE 15°
34	300211	NOZZLE 25°
35	300139	NOZZLE 40°
36	300030	SOAP NOZZLE
37	300031	NOZZLE CLEANER
38	300032	SHEATH, NOZZLE CLEANER
39	300033	SPARK PLUG SLEEVE
40	-	FUNNEL
41	300023	OIL BOTTLE
42	-	RUBBER SLEEVE

# WPX3100 ENGINE VIEW

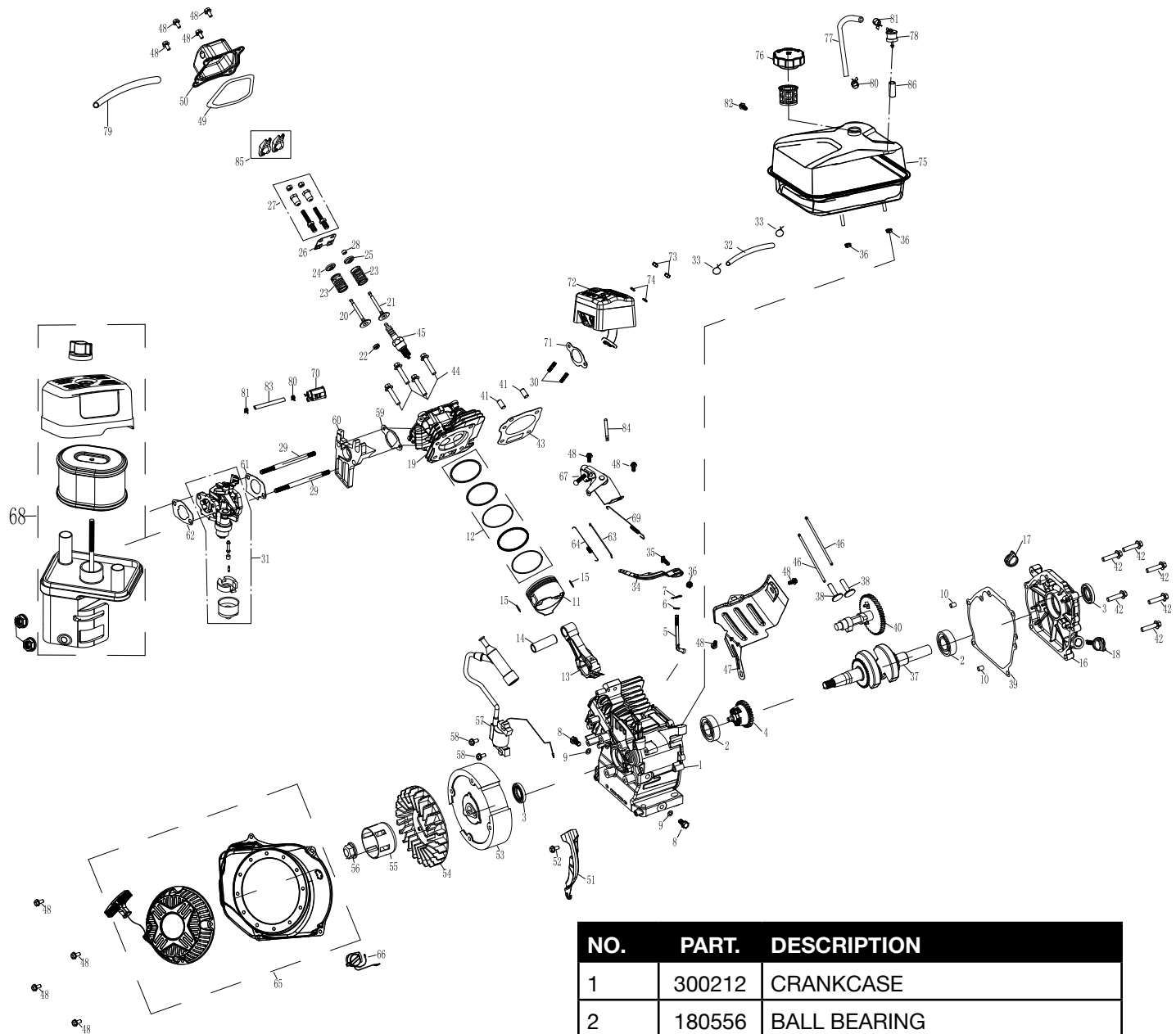

NO.	PART.	DESCRIPTION
1	300212	CRANKCASE
2	180556	BALL BEARING
3	180541	OIL SEAL
4	300213	GOVERNOR ASSEMBLY
5	-	SHAFT, GOVERNOR ARM
6	-	WASHER, GOVERNOR ARM SHAFT
7	-	PIN, LOCK
8	-	BOLT DRAIN PLUG
9	-	WASHER, DRAIN PLUG
10	-	DOWEL PIN, CASECOVER
11	300216	PISTON

# WPX3100 ENGINE PART NUMBERS

NO.	PART.	DESCRIPTION
12	300217	SCRAPER RING SET, PISTON
13	300218	ROD ASSEMBLY., CONNECTING
14	180851	PIN, PISTON
15	180707	CLIP, PISTON
16	300219	COVER ASSEMBLY, CRANKCASE
17	300220	OIL PLUG
18	300221	DIPSTICK
19	300222	CYLINDER HEAD
20	180863	VALVE, IN
21	300223	VALVE EXHAUST
22	180865	RETURNER, INTAKE VALVE
23	180866	SPRING, VALVE
24	180867	SEAT, VALVE SPRING,IN
25	180868	SEAT, VALVE SPRING,EX
26	180870	PLATE, PUSH ROD GUIDE
27	180636	ROCKER ARM TIGHTENINIG BOLTS
28	180869	ROTATOR
29	-	BOLT, STUD
30	-	BOLT, STUD
31	300225	CARBURETOR ASSEMBLY
32	-	FUEL LINE
33	-	CLIP, FUEL LINE
34	-	GOVERNOR ARM
35	-	BOLT, GOVERNOR ARM
36	-	NUT
37	300226	CRANKSHAFT ASSEMBLY
38	300227	LIFTER, VALVE
39	300228	PACKING,CASECOVER
40	300229	CAMSHAFT ASSEMBLY
41	-	PIN DOWEL
42	-	BOLT
43	180547	GASKET, CYLINDER HEAD
44	-	BOLT
45	180526	SPARK PULG
46	300171	ROD, PUSH
47	-	SHROUD
48	-	BOLT M6X12
49	180555	PACKING, HEADCOVER
50	-	COVER COMP, CYLINDER HEAD

NO.	PART.	DESCRIPTION
51	-	WIND SHIEL COMP.
52	-	DISC BOLT M6X20.
53	-	FLYWHEEL ASSEMBLY
54	-	FAN,RECOIL STARTER
55	-	PULLEY,STARTER
56	-	NUT M14
57	180542	IGNITION COIL ASSY
58	-	BOLT
59	300232	PACKING, INTAKE
60	140514	INSULATOR, CARBURETOR
61	300233	PACKING, CARBURETOR
62	140517	SPACER, CARBURETOR
63	180570	ROD, GOVERNOR
64	180551	SPRING, THROTTL RETURN
65	300234	RECOIL STARTER ASSEMBLY
66	300235	SWITCH ASSEMBLY
67	-	SHROUD ASSY, UPPER
68	300237	AIR CLEANER ASSEMBLY
69	180550	SPRING, GOVERNOR
70	300238	CARBON TANK COMP
71	300239	PACKING, EXHAUST
72	300240	MUFFLER COMP
73	-	NUT
74	-	SPRING WASHER
75	300241	FUEL TANK
76	300242	FUEL TANK CAP COMP
77	300243	CONNECTING PIPE
78	300244	MANUAL CHOKE ASSEMBLY
79	-	TUBE, BREATHER
80	-	CLIP, FUEL LINE
81	-	CLIP, FUEL LINE
82	-	BOLT
83	300246	CONNECTING PIPE
84	-	CLIP, WIRE HARNESS
85	180872	ROCKER ARM
86	300247	BUMPER, BREATHER PIPE



[www.wpowereq.com](http://www.wpowereq.com)

**Service Hotline: (855) 944-3571**

**777 Manor Park Drive  
Columbus, OH 43228**

™ & © 2018 Westinghouse Electric Corporation  
© 2018 MWE Investments, LLC. All Rights Reserved.

**Version 5.7.18KD**